

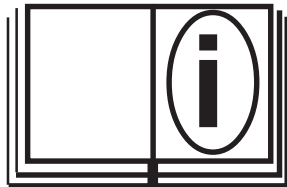

UTILITY VAC
77-000-15

SWIVEL TM-7 UTILITY VAC
77-000-16



	PIPE & VALVE
	MAINTENANCE PRODUCTS
Mod. 77-000-002 S/N: <input type="text"/> <input type="text"/> <input type="text"/> <input type="text"/> <input type="text"/> <input type="text"/> <input type="text"/>	
E.H. WACHS COMPANIES 100 Shepard St. Wheeling Il. 60090	

Part Number: _____

Revision No: 1

March '05

UTILITY VAC

SECTION I

SAFETY INSTRUCTIONS

The E. H. Wachs Company takes great pride in manufacturing safe, quality products with user safety a priority. The E.H. Wachs Company recommends that all users comply with the following safety rules and instructions when operating our equipment. For your safety and the safety of others, read and understand these safety recommendations and operating instructions before operating.



Read the Following thoroughly before proceeding.

1. **READ THE OPERATING MANUAL!!** Reading the setup and operating instructions prior to beginning the setup procedures can save valuable time and help prevent injury to operators or damage to machines.
2. **INSPECT MACHINE & ACCESSORIES!** Prior to machine setup physically inspect the machine and it's accessories. Look for worn tool slides, loose bolts or nuts, lubricant leakage, excessive rust, etc. A properly maintained machine can greatly decrease the chances for injury.
3. **ALWAYS READ PLACARDS & LABELS!** All placards, labels and stickers must be clearly legible and in good condition. Replacement labels can be purchased from the manufacturer.
4. **KEEP CLEAR OF ROTATING PARTS!** Keep hands, arms and fingers clear of all rotating or moving parts. Always turn machine off before attempting any adjustments requiring contact with the machine or it's accessories.
5. **SECURE LOOSE CLOTHING & JEWELRY!** Loose fitting clothing, jewelry; long, unbound hair can get caught in the rotating parts on machines. By keeping these things secure or removing them you can greatly reduce the chance for injury.
6. **KEEP WORK AREA CLEAR!** Be sure to keep the work area free of clutter and nonessential materials. Only allow those personnel directly associated with the work being performed to have access to the area if possible.

ALWAYS WEAR PROTECTIVE EQUIPMENT:

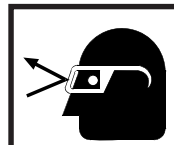

WARNING

Impact resistant eye protection must be worn while operating or working near this tool.

For additional information on eye and face protection, refer to federal OSHA regulations, 29 Code of Federal Regulations, Section 1910.133., Eye and Face Protection and American National Standards Institute, ANSI Z87.1, Occupational and Educational Eye and Face Protection. Z87.1 is available from the American National Standards Institute, Inc., 1430 Broadway, New York, NY 10018.

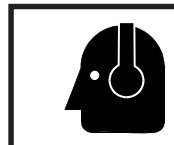

CAUTION

Personal hearing protection is recommended when operating or working near this tool.

Hearing protectors are required in high noise areas, 85 DBA or greater. The operation of other tools and equipment in the area, reflective surfaces, process noises and resonant structures can substantially contribute to and increase the noise level in the area. For additional information on hearing protection, refer to federal OSHA regulations, 29 Code of Federal Regulations, Section 1910.95, Occupational Noise Exposure and ANSI S12.6 Hearing Protectors.

UTILITY VAC

SECTION II

MACHINE SPECIFICATIONS

VALVE MAINTENANCE SYSTEMS

Clean-out and exercise all valve boxes and valves with a complete maintenance system!

The **Utility Vac** can be ordered to meet specific customer needs or in conjunction with Wachs Portable Valve Operators, pipe cutters and other options such as water jet systems can be included.

- *Clean out valve boxes fast.*
- *Turn all valves safely and easily...for emergency or routine maintenance*
- *Automatically capture valve data. Download to utility computer system*
- *Operate other hydraulic tools*



Custom paint to match utilities vehicle fleet, with integrated wand storage system.



Curbside dump vac with 180° swiveling TM-7 valve operator.



Skid mounted unit with optional water jet system.



TM-7 valve operator with vertical tank Trav-L-Vac 300.

<u>POWER SOURCE:</u>	20 H.P. Kohler air cooled gasoline engine (Standard) Optional: 27 H.P. Kohler air cooled gasoline engine with heavy duty air cleaner. (Required with pressure washer system.)
<u>CONTROLS:</u>	Curbside Control Panel includes: Tachometer, Hour Meter, Vacuum Break, Oil Sentry Light, Vacuum Gauge, Dump Switch, Warning Strobe Switch and optional Pressure Washer Switch.
<u>BLOWER:</u>	Belt drive, positive displacement rotary lobe impeller with 500 cfm @ 12" Hg max vacuum. 14,000 FPM air flow through 3" hose.
<u>FILTRATION:</u>	3 stage Filtration consisting of a heavy material drop out debris tank, a self-contained primary and secondary filter with 10 micron polyester reusable cartridge. All filters, washable with mild soap and water.
<u>Optional Filtration:</u>	Cyclone pre filter to remove medium dust particles prior to final filtering. (Recommended for high dust applications)
<u>SPOILS TANK:</u>	200 liquid gallon holding capacity. Top hinged full opening 42" diameter dump door with sure seal square gasket. 6" mechanical ball shut off and 3" drain valve.
<u>DUMPING:</u>	Twin cylinder electric over hydraulic dump system with the new slide and tip system for mounted applications. This unique system moves the tank 12" to clear the bed of the truck. Automatically tilts 60°. Designed to clear the truck bed while not compromising clearance.
<u>PRESSURE WASHER:</u>	(Only available with the 27 H.P. engine) 2.5 gpm, 3000 psi pressure washer with thermal overload protection. 5 gallon antifreeze tank, 125 gallon water holding tank and antifreeze/water selector valve.
<u>TRAILERS:</u>	Optional Trailer: (Required when purchasing a pressure washer system.) 5'x12' with dual axle electric brakes rated at 7000 GVW. All steel construction with diamond plate metal deck. (Pintle hitch only.)
<u>FINISH:</u>	2 part urethane.
<u>DIMENSIONS:</u>	Power Plant: 54" wide by 46" Long, Tank: 45 1/2" wide by 55" long, Total Foot Print: 55" wide by 101" long. Overall length with pressure washer system 144"
<u>Weight:</u>	Dry weight 4500 lbs., Tongue weight 800 lbs.
<u>HOSE:</u>	3" x 20'
<u>WAND:</u>	3" x 6 1/2'
<u>Optional Wands:</u>	2" x 6 1/2", 1 1/4" 6 1/2", 3" Excavation Wand (emulsifier).

UTILITY VAC

SECTION III

SET-UP AND OPERATION

PRE-VACUUM CHECKLIST:

1. Insure all scheduled maintenance has been properly performed. See maintenance section in manual or refer to maintenance decal on *UTILITY VAC*.
2. Insure that the hitch assembly has been properly attached to the towing vehicle.
3. Check trailer brake lights and turn signals.
4. Check *UTILITY VAC* fuel level.
5. Make certain battery is charged and ready to start *UTILITY VAC* engine.
6. Make certain suction hose and suction tubes are stored on board *UTILITY VAC*



FIGURE 2

UTILITY VAC SET UP PROCEDURE:

1. Position *UTILITY VAC* near work area.
2. Connect coupling of suction hose to coupling on vacuum inlet port. (Figure 1)
3. Connect coupling on suction hose to coupling on suction tube (Figure 2).
4. Once assembly of these components is complete, unit is ready for operation.

UTILITY VAC OPERATING PROCEDURE:

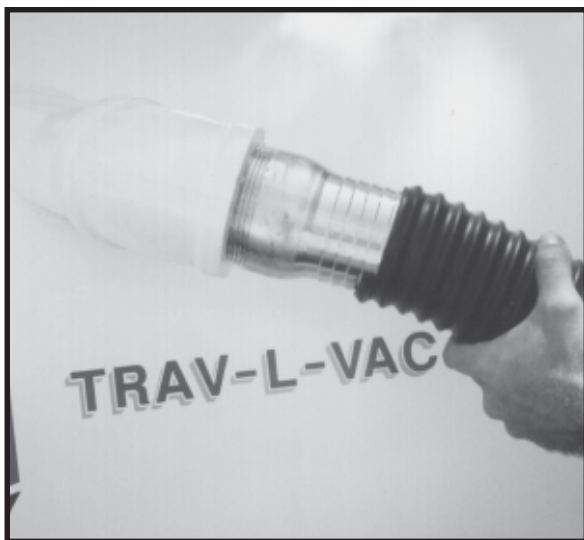

FIGURE 1

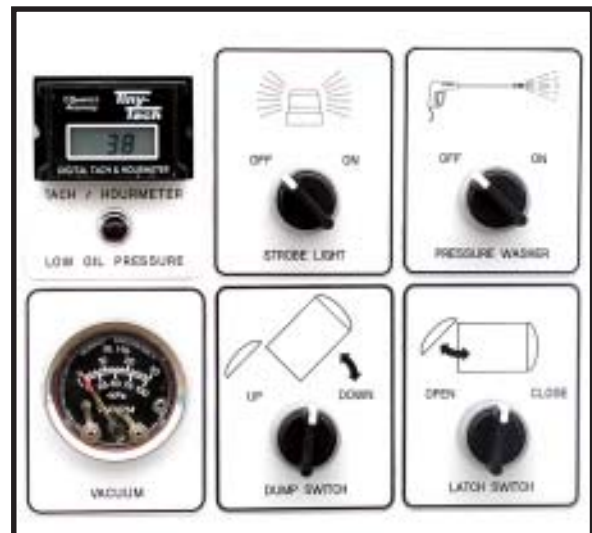

FIGURE 3

UTILITY VAC

SECTION III

SET-UP AND OPERATION (information)

CLOGGED LINES:

If a clog occurs open break valve to release vacuum pressure. Remove hose or vacuum wand from unit and clear clog. Reassemble and close vacuum break valve to continue clean out. FIGURE 4



Vacuum break valve FIGURE 4

UTILITY VAC EQUIPPED WITH SWIVELING VALVE OPERATOR

1. If your Utility Vac system is equipped with a Wachs Valve exerciser please refer to the valve operator operation manual supplied for the machine. The swivel vac trailer allows the operator to position the valve actuator quickly and effortlessly over the operating nut. The unit can swivel a full 180 degrees to line up over even the most difficult locations. To do this release the two lock clamps holding the machine in location. Rotate the machine parallel to the valve vault or nut. Release the lock handle on the side of the Valve operator and extend the head over the nut. Drop the key and socket onto the nut. Once you have aligned the actuator lock both of the clamps on the swivel plate and the clamp on the actuator to lock the head in position,. Start valve operation and continue until finished. (Always return head on actuator and swivel to its travel position prior to moving to the next valve).



TM-7 Swiveling Valve Operator

4. If the unit fills with liquid to its limit, the high liquid level float will automatically shut off the air flow. Before restarting unit, the holding tank must be drained. If this is not done, unit will not operate.



UTILITY VAC

SECTION III

SET-UP AND OPERATION (cont.)

VACUUM CONTROL PANEL

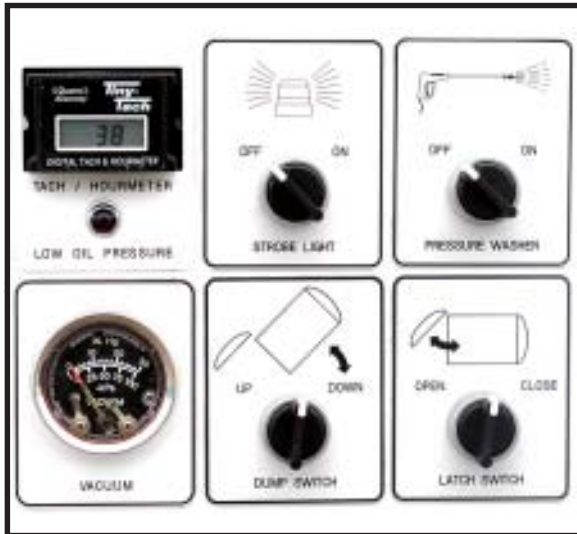

FIGURE 5

UTILITY VAC DUMPING PROCEDURES:

Liquids:

1. Shut down engine.
2. Position vacuum system over designated dumping area.
3. If the material collected is primarily liquid, the holding tank drain valve should be used to remove holding tank contents (Figure).
4. Once liquid has drained, from the vacuum control panel open dump gate and remove any remaining debris. (Figure 5)
5. Clean primary filter prior to next use. Filter can be cleaned with only water, however, mild soap and water are recommended if possible.

Solids:

1. Shut down engine.
2. Position vacuum system over designated dumping area.
3. If the material collected is primarily solid, first open the holding tank drain valve to allow any trapped liquids to escape. Back tank up to dump position. Open tank door and proceed to the 45 degree dump position.
4. It may be necessary to remove any remaining debris from the holding tank manually.
5. Clean primary filter prior to next use. Filter can be cleaned with only water, however, mild soap and water are recommended if possible.



FIGURE 5

UTILITY VAC

SECTION III

SET-UP AND OPERATION (cont.)

OPERATING TIPS

1. While excavating water, always be sure to skin surface with the suction tube submerge only when necessary.
2. If debris is packed in the bottom of the valve box, rotate the suction tube assembly back and forth to break up debris.
3. For solid debris, pouring water into the valve box greatly speeds up debris removal.
4. If suction tube on the *UTILITY VAC* becomes clogged, use a rod with a smaller diameter than the inside of tube to assist in blockage removal.
5. For optimal efficiency, flush out suction tubes and suction hoses prior to storage.
6. Properly performing all scheduled operators maintenance at the designated times will insure continued peak performance and increase the longevity of the *UTILITY VAC* unit.
7. To protect your TM Valve Operator replace cover during travel and storage. UNIT MUST BE COLD BEFORE INSTALLING COVER. THE HEAT FROM THE MUFFLER WILL DAMAGE THE COVER AND COULD POSSIBLY CAUSE A FIRE).



TM Valve Operator protective cover.

SECTION IV

MAINTENANCE

FILTER REMOVAL

1. Unscrew the four wing nuts that secure the filter cover to the filter housing. Remove cover (Figure 6).
2. Unscrew wing nut that secures filter to housing. Remove filter (Figure 7).



CAUTION: DO NOT remove filter while machine is operating. Always shut down vacuum during maintenance.



FIGURE 6



FIGURE 7

UTILITY VAC

SECTION IV

MAINTENANCE (cont.)

BLOWER MAINTENANCE SCHEDULE

WEEKLY

CHECK OIL LEVEL:

Stop blower. Wait 5 minutes. Remove oil breather and oil level plug. Add oil until oil runs out level holes. Replace breather and level plugs.

GREASE BEARINGS:

Grease drive end bearings with NLGI grade 2 EP grease in a pressure gun. Force into housing through grease fittings until clean grease emerges from relief fittings. Wipe clean all grease from around relief fittings to prevent spraying onto drive belts.

EVERY 1,000 HOURS

CHANGE OIL.

NOTES

Change oil after initial 100 hours.
Recommended oil: Mobil DTE BB, Amoco 220, Texaco R&O 220, or equivalent .

FILTER MAINTENANCE SCHEDULE

DAILY

Clean primary filter.

WEEKLY

Clean pre-filter

NOTES

Frequency of cleaning will increase under severe operating conditions.
All filters are washable with mild detergent and water.
Damaged filters must be replaced to prevent damage

GENERAL MAINTENANCE SCHEDULE

DAILY

Check suction hoses for any abrasions, holes, kinks or damaged connectors. Replace as needed.

Verify that all dump gate and filter lid camps are secured tight. Adjust if necessary.

Clean any debris from dump door seal.

Verify that all trailer and/or accessory lights are functioning properly. Repair or replace as needed.

WEEKLY

Clean holding tank from excessive debris build-up.

Check lug nuts and fasteners for tightness. Tighten as necessary.

MONTHLY

Check blower drive belts for proper tension, frayed or cracked condition. Adjust or replace as needed.

Check for loose piping, fittings, and connectors. Tighten as needed.

Check tire pressure. Fill as necessary.

UTILITY VAC

77-HYDRAULIC WITH DOOR

REF. No.	PART No.	QTY.	DESCRIPTION	INSTALLATION NOTES
	68-132-00		HPU	FILL WITH DEXTRON AUTOMATIC TRANSMISSION FLUID
2	68-123-00	4	ADAPTER -6 JIC x -6 ORB	-6 ORB TORQUE 34-36 FT.-LB.
3	77-140-00	2	HYD. HOSE ASSEMBLY (106" LONG)	-6 JIC TORQUE 20-22 FT.-LB.
4	68-121-01	4	NUT, -6 (9/16"-18 THREAD)	9/16"-18 NUT TORQUE 88 FT.-LB.; USE THRD. LOCK
5	77-123-00	4	BULKHEAD TEE FITTING; -6 JIC	-
6	77-078-00	2	HYD. HOSE ASSEMBLY (42" LONG)	-6 JIC TORQUE 20-22 FT.-LB.
7	77-079-00	2	HYD. HOSE ASSEMBLY (22" LONG)	-6 JIC TORQUE 20-22 FT.-LB.
8	77-122-00	4	ADAPTER 90 DEG -6 JIC x -8 ORB	-8 ORB TORQUE 58-62 FT.-LB.
9	77-015-01	2	HYDRAULIC CYLINDER	2" BORE, 18" STROKE
10	68-103-00	2	HYDRAULIC CYLINDER	2" BORE, 4" STROKE
11	68-122-00	4	ADAPTER -6 JIC x 3/8" MPT	3/8" NPT 2-3 T.F.F.T.; USE THREAD SEALANT
12	77-144-00	2	HYD. HOSE ASSEMBLY (??" LONG)	-6 JIC TORQUE 20-22 FT.-LB.
13	77-145-00	2	HYD. HOSE ASSEMBLY (??" LONG)	-6 JIC TORQUE 20-22 FT.-LB.

UTILITY VAC

77-PRESSURE WASHER

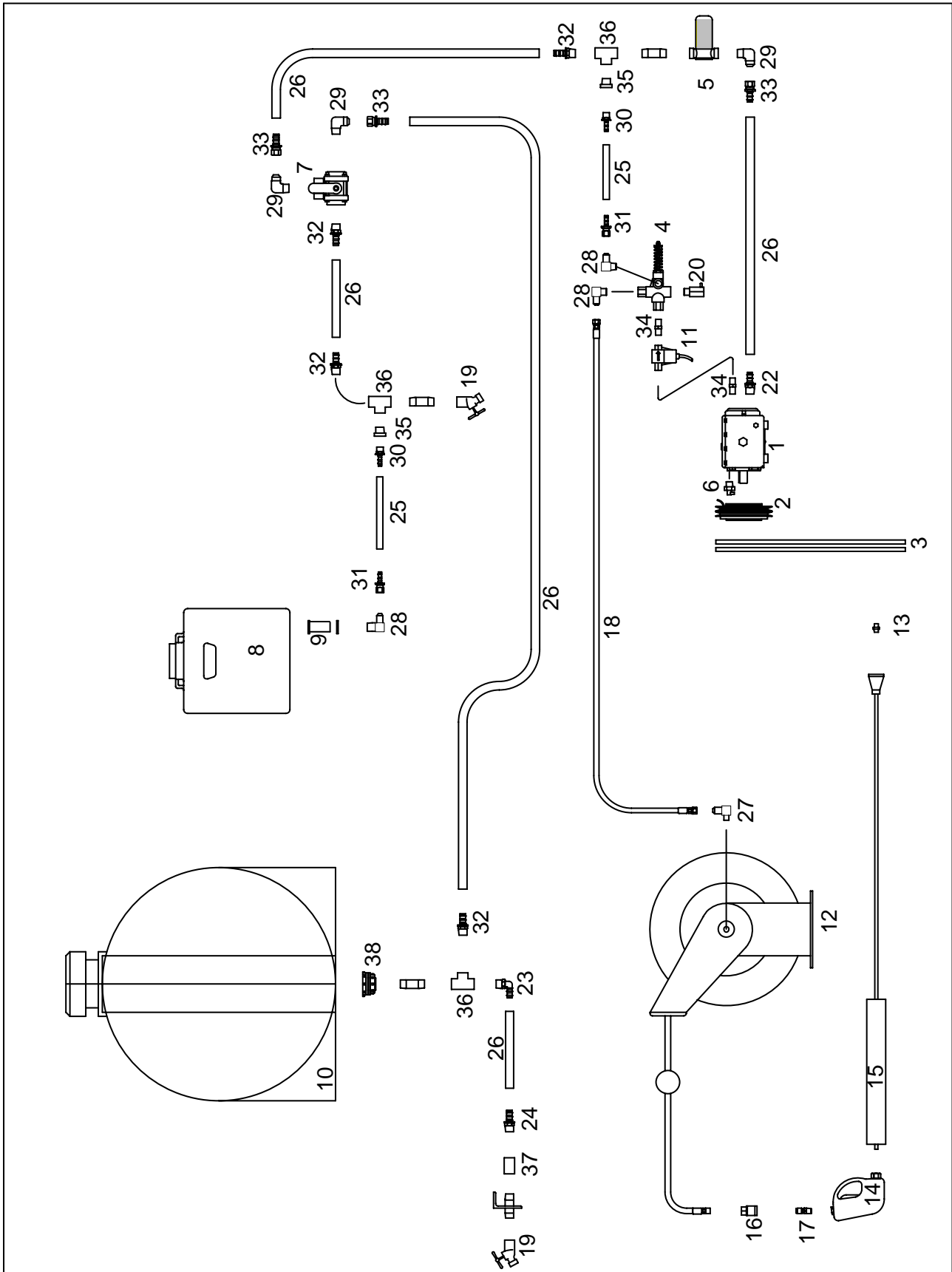

UTILITY VAC

77-PRESSURE WASHER

	77-085-00			
2	77-100-00			
3	77-127-00	2		
4	68-137-00			
5	68-138-01			
6	68-140-00			
7	68-141-00		3-WA	
8	68-146-00		ANTI-FREEZE TANK	
9	68-168-00		BULKHEAD FITTING, 1/2" NPT	
10	67-170-00		110 GALLON TANK	
11	68-188-00		FLOW SWITCH	
12	68-195-00		HOSE REEL w/ 50' 3/8" HOSE	
13			NOZZLE, .040 x 15°	
14	68-199-00		SPRAY GUN	
15	68-200-00		LANCE	-
16	68-201-00		3/8" FPT STAINLESS COUPLER	2-3 T.F.F.T.
17	68-202-00		3/8" MPT STAINLESS NIPPLE	2-3 T.F.F.T.
18	77-193-10		HOSE ASSEMBLY (74" LONG)	-8 JIC TORQUE 34-38 FT.-LB.
19	68-242-00	2	DRAIN COCK	THREAD ON TO 3/4" PIPE ON TRAILER
20	68-193-00		SAFETY RELIEF VALVE	SET VALVE AT 4200 PSI
21				
22	77-133-00		COUPLING, 3/4" HOSE x -6MPT	TORQUE TO 25 FT.-LB.
23	77-104-00		COUPLING, 3/4" HOSE -12 MPT 90° PLASTIC	-
24	77-103-00		COUPLING, 3/4" HOSE x -12 MPT PLASTIC	-
25	68-184-02	24"	1/2" LOW PRESSURE PUSH ON HOSE	-
26	68-233-00	120"	3/4" LOW PRESSURE PUSH ON HOSE	-
27	90-078-59		ADAPTER, -8 MJ x -6 MPT 90°	-6 MP 2-3 T.F.F.T.; -8 JIC TORQUE 34-38 FT.-LB.
28	68-182-03		ADAPTER, -8 MJ x -8 MPT 90°	-8 MP 2-3 T.F.F.T.; -8 JIC TORQUE 34-38 FT.-LB.
29	90-218-75	2	ADAPTER, -12 MJ x -12 MPT 90°	-12 MP 2-3 T.F.F.T.; -12 JIC TORQUE 78 FT.-LB.
30	68-185-00	2	COUPLING, 1/2" HOSE x 1/2" MPT	-
31	68-183-00	2	COUPLING, 1/2" HOSE x 3/4-16 F JIC	-
32	68-243-00		COUPLING, 3/4" HOSE x 3/4" MPT	-
33	68-232-00	2	COUPLING, 3/4" HOSE x 1-1/16" F JIC	-
34	68-240-02		ADAPTER, -6 MPT x -6 MPT	-6 MP 2-3 T.F.F.T.
35	68-240-00	2	ADAPTER, -12 MPT x -8 FPT	-12 MP 2-3 T.F.F.T.
36	68-189-01	3	TEE, -12 FPT x -12 FPT x -12 FPT	-
37				
38				

UTILITY VAC

77-SWIVELPRESSURE WASHER

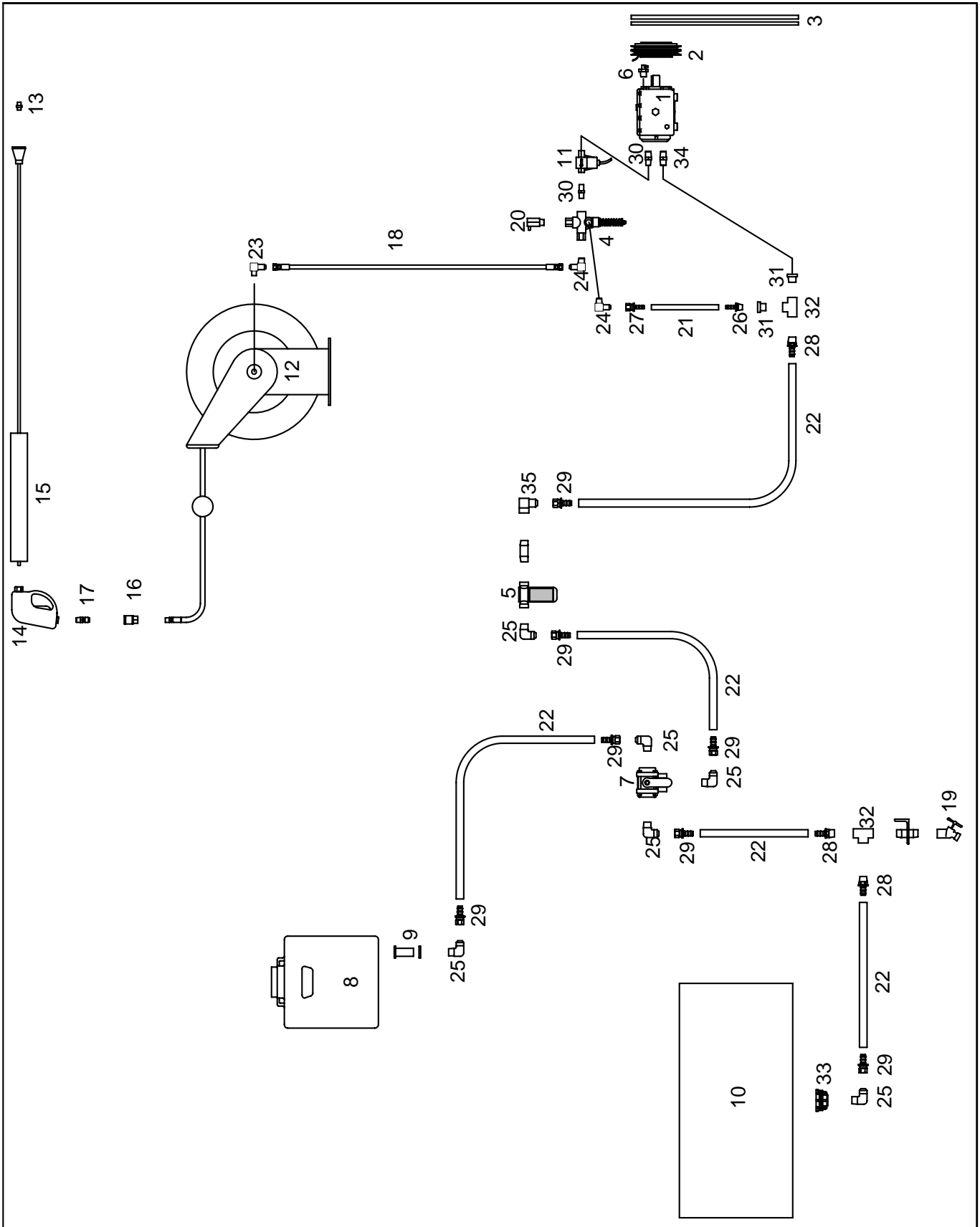

UTILITY VAC

77-SWIVELPRESSURE WASHER

1			PUM P, 2.6 GPM ; 3000 PSI	
2	77-100-00	1	CLUTCH, 12 VD C	
3	77-127-00	2	BELT, AX41	
4	68-137-00	1	UNLOADER VALVE	
5	68-138-01	1	STRAINER	
6	68-140-00	1	THERMAL VALVE	
7	68-141-00	1	3-WA	
8	68-146-00	1		
9	68-168-00	1	BULKHEAD FI TTING, 1/2" NP T	
10	77-162-00	1	95 GAL LON TANK	
11	68-188-00	1	FLOW SWI TCH	
12	68-195-00	1	HOSE REEL w/ 50' 3/8" HOSE	
13		1	NOZZL E, .040 x 15 °	
14	68-199-00	1	SPRAY GU N	
15	68-200-00	1	LANCE	
16	68-201-00	1	3/8" FPT S TAINLESS COUPLER	
17	68-202-00	1	3/8" MPT S TAINLESS NIPPL E	
18	77-193-00	1	HOSE ASSEMB LY (50" LONG)	-8 JIC TORQUE 34-38 F T.-LB,
19	68-242-00	1	DRAIN COCK	THREAD ON TO 3/4" PIPE ON T RAILER
20	68-193-00	1	SAFE TY RELIEF VALVE	SET VALVE AT 4200 PSI
21	68-184-02	18"	1/2" LOW PRESSURE PUSH ON HOS E	-
22	68-233-00	164"	3/4" LOW PRESSURE PUSH ON HOS E	-
23	90-078-59	1	ADAPTER , -8 MJ x -6 MPT 90 °	-6 MP 2-3 T.F.F.T.; -8 JIC TORQUE 34-38 F T.-LB.
24	68-182-03	2	ADAPTER , -8 MJ x -8 MPT 90 °	-8 MP 2-3 T.F.F.T.; -8 JIC TORQUE 34-38 F T.-LB.
25	90-128-75	6	ADAPTER , -12 MJ x -12 MPT 90 °	-12 MP 2-3 T.F.F.T.; -12 JIC TORQUE 78 F T.-LB.
26	68-185-00	1	COUPLING , 1/2" HOSE x 1/2" MP T	-
27	68-183-00	1	COUPLING , 1/2" HOSE x 3/4-16 F JI C	-
28	68-243-00	3	COUPLING , 3/4" HOSE x 3/4" MP T	-
29	68-232-00	7	COUPLING , 3/4" HOSE x 1-1/16" F JI C	-
30	68-240-02	2	ADAPTER , -6 MPT x -6 MP T	-6 MP 2-3 T.F.F.T.
31	68-240-00	2	ADAPTER , -12 MPT x -8 FP T	-12 MP 2-3 T.F.F.T.
32	68-189-01	2	TEE, -12 FPT x -12 FPT x -12 FP T	-
33	67-171-00	1	BULKHEAD FI TTING, 3/4 MP T	DRILL HOLE IN WATER TANK TO MOUN T
34	90-098-58	1	ADAPTER , -8 NPT (M) x -8 NPT (M)	

UTILITY VAC

SECTION VI

PARTS LIST BILL OF MATERIALS

77-000-15 Utility Vac



UTILITY VAC

77-403-20 20 HP Gasoline Powerpack

Part Number	Description	Qty
77-310-00	Pha - Power Pack Base Assembly	1
67-006-01	Element, Filter	1
67-020-00	Cap,Filter Element	1
68-130-04	Bushing, 1610 X 7/8	1
68-134-00	Nipple, 3" Npt x 3" Combination Hose	1
68-158-04	Hose Clamp .21-.63"	2
68-158-46	Hose Clamp,3.75-4.63	2
68-158-56	Hose Clamp, 3" Spiral	7
68-160-03	Hose, 3" Vacuum	202
68-160-04	Hose, 4" Vacuum	22
68-164-00	Vacuum Relief	2
68-165-00	1" Grommet	4
68-171-01	Tubing, 1/4" Nylon 6	12
68-172-08	Elbow Comp. Fitting	1
68-172-09	Compression Fitting	1
68-173-01	Terminal Block	8
68-173-02	Fuse Block	5
68-173-04	Fixed Bridge Bar	1
68-173-05	Partition Plate	5
68-173-06	End Clamp	2
68-175-05	Fuse, 5 Amp	5
68-177-02	Gauge, Vacuum	1
68-177-08	Panel Light	1
68-179-01	Switch, 3-Way Moment	1
68-179-02	Switch, 2 Pos Select	1
68-194-04	Label, Dump Switch	1
77-014-01	Silencer	1
77-058-00	Wldmnt, Pwrpck Frame	1
68-037-13	Hpu Spacer	1
68-037-14	Tube, Cyclone Mount	1
68-063-41	Nipple, 3/4 x 3 SS	2
77-058-10	Base Plate	1
77-058-11	Tube, Cyclone Pilar	1
77-058-12	Plate, Pilar Support	1
77-058-13	Bar, Strainer	1
77-058-14	Bar, Drain	1
77-058-15	Angle	4
77-058-16	Din Rail	1
77-058-17	Panel, Din	1
77-058-18	Blower, Side Guard	2
77-058-19	Blower Support Bar	1
77-058-20	Plate, Fuel	1
77-058-21	Filter Plate	1
77-058-22	Filter, Gussets	2
77-058-23	Front Cross Plate	1
77-058-24	Mid Cross Plate	1
77-058-25	Rear Cross Plate	1
77-058-26	Sleeve, Fuel Retainr	1
77-058-29	Wldmnt, P.W. Mount	1
77-058-30	Mount, Pressure Wash	1
90-095-12	NUT, 1/2-13 WELD	2

UTILITY VAC

77-403-20 20 HP Gasoline Powerpack

Part Number	Description	Qty
77-070-00	Weldment, Filter	1
68-043-13	Bracket, Filter	1
68-043-16	Rod, Threaded	1
77-070-10	Body, Filter	1
77-070-11	Bottom, Filter	1
77-070-12	Surface, Filter Seal	1
77-070-13	Hinge, Filter	2
77-070-14	Bracket, Latch	6
77-070-15	Tube, Filter Output	1
77-070-16	Tube, Filter Inlet	1
77-070-17	Ring, Filter Guide	1
77-070-18	Tube, Filter Inlet	1
77-178-00	2" Weld On Tank Fitting	2
90-055-07	NUT, 1/4-20 WELD	15
90-075-10	NUT, 3/8-16 WELD	20
77-059-00	Panel, Vac Break	1
77-060-00	Panel, Controls	1
77-061-00	Panel Instructions	1
77-062-00	Panel, Water Drain	1
77-064-00	Wldmnt, Inlet	1
68-034-11	Elbow, 3" 90deg Shrt	1
77-064-10	Nipple, Modified	1
77-064-12	Nipple, 3" NPT x 8" Schd 40	1
77-064-11	3" Dia X 2" Tube	1
77-069-00	Wldmnt, Vac Break Inlet	1
77-069-10	Modified Nipple	1
77-064-12	Nipple, 3" NPT x 8" Schd 40	0.5
77-171-11	Bracket, Nipple Mounting	2
77-071-00	Weldment, Filter Door	1
77-071-10	Door, Filter	1
77-071-11	Hinge, Door	1
77-081-00	Wldmnt, Blwr Tension	1
77-081-10	Bracket, Blwr Tensioner	1
90-075-10	NUT, 3/8-16 WELD	4
90-095-12	NUT, 1/2-13 WELD	2
77-084-00	Wldmnt, Fuel Tnk Ret	1
77-084-10	Stop, Tank	1
77-084-11	Shldr, Tank Retainer	1
77-084-12	Rod, Fuel Retainer	1
77-086-00	500 Cfm Blower	1
77-087-00	Wldmnt, Engine Guard	1
77-087-10	Guard, Engine Belt	1
90-055-07	NUT, 1/4-20 WELD	2
77-088-00	Wldmnt, Blower Guard	1
77-088-10	Guard, Blower Side	1
77-088-11	Guard, Blower Front	1
77-089-00	Wldmnt, P.W. Guard	1
77-089-10	Guard, P.W. Outside	1
77-089-11	Guard, P.W. Inside	1
77-093-00	Label, Vacuum	1
77-094-00	Label, Safety	1
77-095-00	Label, Vacuum Break	1
77-106-00	Elbow, 3" Street	1

UTILITY VAC

77-403-20 20 HP Gasoline Powerpack

Part Number	Description	Qty
77-107-00	RodEnd, 3/8" SS	3
77-110-00	Sheave, 2/3 V6.50	2
77-111-00	Belt, 2/3vx475	1
77-116-00	Knob, Filter	1
77-139-00	1" Grommet	2
77-141-00	Weldment, Filter Inlet	1
77-141-10	Tube, Filter Inlet	1
77-141-11	3" Tube	1
77-141-12	Adapter, 4" To 3"	1
77-142-00	Diode	6
77-148-00	Seal, Filter	1
77-202-00	Weldment, Electrical Enclosure	1
77-166-10	Din, Rail	1
77-166-09	Rail, DIN 3 - 35mm x 7.5mm x 39"	0.25
77-202-10	Enclosure, Electrical	1
77-203-00	Mount, Cable Tie	4
90-036-97	PIN, COTTER 5/32	5
90-055-01	NUT, 1/4-20 HEX	2
90-055-52	WASHER, 1/4 SPLIT RING	2
90-067-64	BOLT, STRIPPER 5/16 X 1-1/2	1
90-071-07	HHCS, 3/8-16 X 3/4	16
90-071-12	HHCS, 3/8-16 X 1-1/4	4
90-071-17	HHCS, 3/8-16 X 1-3/4	4
90-075-01	NUT, 3/8-16 HEX	6
90-075-10	NUT, 3/8-16 WELD	3
90-075-53	WASHER, 3/8 FLAT	24
90-079-90	PIN, CLEVIS 3/8 X 1"	5
90-091-10	HHCS, 1/2-13 X 1	2
90-091-41	HHCS, 1/2-13 X 4 FL THD	2
90-151-06	HHCS, 1/4-20 X 5/8 - SS	13
90-155-52	WASHER, 1/4 SPLIT RING - SS	13
90-155-56	WASHER, #12 FLAT - SS	13
90-219-01	RING, 3/4 EXT RETAIN	1
77-313-01	Pha - 20 Hp Engine	1
17-088-00	Tank, Fuel	1
59-033-01	Kohler Ch20s	1
59-035-00	Tach / Hourmeter	1
67-051-00	Case,Battery	1
68-142-00	Battery	1
68-158-04	Hose Clamp .21-.63"	2
68-159-25	1/4" Fuel Line	20
68-177-08	Panel Light	1
77-067-00	Plate, 3-Way Cover	1
77-092-00	Label, Low Oil Press	1
77-112-01	Bushing, 1610x1-1/8"	1
77-113-00	Muffler	1
77-114-00	Muffler Guard	1
77-132-00	Clamp	1
77-139-00	1" Grommet	2
77-181-00	Nipple, 3/8 Npt X 2" Long	1
77-182-00	Nipple, 3/8 Npt X 6" Long	1
77-183-00	Elbow, 3/8 Npt	1
77-184-00	Coupling, 3/8"	1
77-185-00	Plug, 3/8"	1
77-186-00	Cap, 1-1/2" Rain	1
77-191-00	One Piece Threaded Clamp On Collar	0
77-192-00	Weldment, Muffler Elbow	1
77-131-00		

UTILITY VAC

77-403-27 27 HP Gasoline Powerpack

Parts Number	Description	Qty
67-006-01	Element, Filter	1
67-020-00	Cap,Filter Element	1
68-130-04	Bushing, 1610 X 7/8	1
68-134-00	Nipple, 3" Npt x 3" Combination Hose	1
68-158-04	Hose Clamp .21-.63"	2
68-158-46	Hose Clamp,3.75-4.63	2
68-158-56	Hose Clamp, 3" Spiral	7
68-160-03	Hose, 3" Vacuum	202
68-160-04	Hose, 4" Vacuum	22
68-164-00	Vacuum Relief	2
68-165-00	1" Grommet	4
68-171-01	Tubing, 1/4" Nylon 6	12
68-172-08	Elbow Comp. Fitting	1
68-172-09	Compression Fitting	1
68-173-01	Terminal Block	8
68-173-02	Fuse Block	5
68-173-04	Fixed Bridge Bar	1
68-173-05	Partition Plate	5
68-173-06	End Clamp	2
68-175-05	Fuse, 5 Amp	5
68-177-02	Gauge, Vacuum	1
68-177-08	Panel Light	1
68-179-01	Switch, 3-Way Moment	1
68-179-02	Switch, 2 Pos Select	1
68-194-04	Label, Dump Switch	1
77-014-01	Silencer	1
77-058-00	Wldmnt, Pwrpck Frame	1
68-037-13	Hpu Spacer	1
68-037-14	Tube, Cyclone Mount	1
68-063-41	Nipple, 3/4 x 3 SS	2
77-058-10	Base Plate	1
77-058-11	Tube, Cyclone Pilar	1
77-058-12	Plate, Pilar Support	1
77-058-13	Bar, Strainer	1
77-058-14	Bar, Drain	1
77-058-15	Angle	4
77-058-16	Din Rail	1
77-058-17	Panel, Din	1
77-058-18	Blower, Side Guard	2
77-058-19	Blower Support Bar	1
77-058-20	Plate, Fuel	1
77-058-21	Filter Plate	1
77-058-22	Filter, Gussets	2
77-058-23	Front Cross Plate	1
77-058-24	Mid Cross Plate	1
77-058-25	Rear Cross Plate	1
77-058-26	Sleeve, Fuel Retainr	1
77-058-29	Wldmnt, P.W. Mount	1
77-058-30	Mount, Pressure Wash	1
90-095-12	NUT, 1/2-13 WELD	2
77-070-00	Weldment, Filter	1

UTILITY VAC

77-403-27 27 HP Gasoline Powerpack

Parts Number	Description	Qty
68-043-13	Bracket, Filter	1
68-043-16	Rod, Threaded	1
77-070-10	Body, Filter	1
77-070-11	Bottom, Filter	1
77-070-12	Surface, Filter Seal	1
77-070-13	Hinge, Filter	2
77-070-14	Bracket, Latch	6
77-070-15	Tube, Filter Output	1
77-070-16	Tube, Filter Inlet	1
77-070-17	Ring, Filter Guide	1
77-070-18	Tube, Filter Inlet	1
77-178-00	2" Weld On Tank Fitting	2
90-055-07	NUT, 1/4-20 WELD	15
90-075-10	NUT, 3/8-16 WELD	20
77-059-00	Panel, Vac Break	1
77-060-00	Panel, Controls	1
77-061-00	Panel Instructions	1
77-062-00	Panel, Water Drain	1
77-064-00	Wldmnt, Inlet	1
68-034-11	Elbow, 3" 90deg Shrt	1
77-064-10	Nipple, Modified	1
77-064-12	Nipple, 3" NPT x 8" Schd 40	1
77-064-11	3" Dia X 2" Tube	1
77-069-00	Wldmnt, Vac Break Inlet	1
77-069-10	Modified Nipple	1
77-064-12	Nipple, 3" NPT x 8" Schd 40	0.5

UTILITY VAC

77-403-H1 Hydraulic Powerpack

Part Number	Description	Qty
67-006-01	Element, Filter	1
67-020-00	Cap,Filter Element	1
68-130-04	Bushing, 1610 X 7/8	1
68-134-00	Nipple, 3" Npt x 3" Combination Hose	1
68-158-04	Hose Clamp .21-.63"	2
68-158-46	Hose Clamp,3.75-4.63	2
68-158-56	Hose Clamp, 3" Spiral	7
68-160-03	Hose, 3" Vacuum	202
68-160-04	Hose, 4" Vacuum	22
68-164-00	Vacuum Relief	2
68-165-00	1" Grommet	4
68-171-01	Tubing, 1/4" Nylon 6	12
68-172-08	Elbow Comp. Fitting	1
68-172-09	Compression Fitting	1
68-173-01	Terminal Block	8
68-173-02	Fuse Block	5
68-173-04	Fixed Bridge Bar	1
68-173-05	Partition Plate	5
68-173-06	End Clamp	2
68-175-05	Fuse, 5 Amp	5
68-177-02	Gauge, Vacuum	1
68-177-08	Panel Light	1
68-179-01	Switch, 3-Way Moment	1
68-179-02	Switch, 2 Pos Select	1
68-194-04	Label, Dump Switch	1
77-014-01	Silencer	1
77-058-00	Wldmnt, Pwrpck Frame	1
68-037-13	Hpu Spacer	1
68-037-14	Tube, Cyclone Mount	1
68-063-41	Nipple, 3/4 x 3 SS	2
77-058-10	Base Plate	1
77-058-11	Tube, Cyclone Pilar	1
77-058-12	Plate, Pilar Support	1
77-058-13	Bar, Strainer	1
77-058-14	Bar, Drain	1
77-058-15	Angle	4
77-058-16	Din Rail	1
77-058-17	Panel, Din	1
77-058-18	Blower, Side Guard	2
77-058-19	Blower Support Bar	1
77-058-20	Plate, Fuel	1
77-058-21	Filter Plate	1
77-058-22	Filter, Gussets	2
77-058-23	Front Cross Plate	1
77-058-24	Mid Cross Plate	1
77-058-25	Rear Cross Plate	1
77-058-26	Sleeve, Fuel Retainr	1
77-058-29	Wldmnt, P.W. Mount	1

UTILITY VAC

77-403-H1 Hydraulic Powerpack

Part Number	Description	Qty
68-043-13	Bracket, Filter	1
68-043-16	Rod, Threaded	1
77-070-10	Body, Filter	1
77-070-11	Bottom, Filter	1
77-070-12	Surface, Filter Seal	1
77-070-13	Hinge, Filter	2
77-070-14	Bracket, Latch	6
77-070-15	Tube, Filter Output	1
77-070-16	Tube, Filter Inlet	1
77-070-17	Ring, Filter Guide	1
77-070-18	Tube, Filter Inlet	1
77-178-00	2" Weld On Tank Fitting	2
90-055-07	NUT, 1/4-20 WELD	15
90-075-10	NUT, 3/8-16 WELD	20
77-059-00	Panel, Vac Break	1
77-060-00	Panel, Controls	1
77-061-00	Panel Instructions	1
77-062-00	Panel, Water Drain	1
77-064-00	Wldmnt, Inlet	1
68-034-11	Elbow, 3" 90deg Shrt	1
77-064-10	Nipple, Modified	1
77-064-12	Nipple, 3" NPT x 8" Schd 40	1
77-064-11	3" Dia X 2" Tube	1
77-069-00	Wldmnt, Vac Break Inlet	1
77-069-10	Modified Nipple	1
77-064-12	Nipple, 3" NPT x 8" Schd 40	0.5
77-171-11	Bracket, Nipple Mounting	2
77-071-00	Weldment, Filter Door	1
77-071-10	Door, Filter	1
77-071-11	Hinge, Door	1
77-081-00	Wldmnt, Blwr Tension	1
77-081-10	Bracket, Blwr Tensioner	1
90-075-10	NUT, 3/8-16 WELD	4
90-095-12	NUT, 1/2-13 WELD	2
77-084-00	Wldmnt, Fuel Tnk Ret	1
77-084-10	Stop, Tank	1
77-084-11	Shldr, Tank Retainer	1
77-084-12	Rod, Fuel Retainer	1
77-086-00	500 Cfm Blower	1
77-087-00	Wldmnt, Engine Guard	1
77-087-10	Guard, Engine Belt	1
90-055-07	NUT, 1/4-20 WELD	2
77-088-00	Wldmnt, Blower Guard	1
77-088-10	Guard, Blower Side	1
77-088-11	Guard, Blower Front	1
77-089-00	Wldmnt, P.W. Guard	1
77-089-10	Guard, P.W. Outside	1
77-089-11	Guard, P.W. Inside	1
77-093-00	Label, Vacuum	1
77-094-00	Label, Safety	1

UTILITY VAC

77-403-H1 Hydraulic Powerpack

Part Number	Description	Qty
77-110-00	Sheave, 2/3 V6.50	2
77-111-00	Belt, 2/3vx475	1
77-116-00	Knob, Filter	1
77-139-00	1" Grommet	2
77-141-00	Weldment, Filter Inlet	1
77-141-10	Tube, Filter Inlet	1
77-141-11	3" Tube	1
77-141-12	Adapter, 4" To 3"	1
77-142-00	Diode	6
77-148-00	Seal, Filter	1
77-202-00	Weldment, Electrical Enclosure	1
77-166-10	Din, Rail	1
77-166-09	Rail, DIN 3 - 35mm x 7.5mm x 39"	0.25
77-202-10	Enclosure, Electrical	1
77-203-00	Mount, Cable Tie	4
90-036-97	PIN, COTTER 5/32	5
90-055-01	NUT, 1/4-20 HEX	2
90-055-52	WASHER, 1/4 SPLIT RING	2
90-067-64	BOLT, STRIPPER 5/16 X 1-1/2	1
90-071-07	HHCS, 3/8-16 X 3/4	16
90-071-12	HHCS, 3/8-16 X 1-1/4	4
90-071-17	HHCS, 3/8-16 X 1-3/4	4
90-075-01	NUT, 3/8-16 HEX	6
90-075-10	NUT, 3/8-16 WELD	3
90-075-53	WASHER, 3/8 FLAT	24
90-079-90	PIN, CLEVIS 3/8 X 1"	5
90-091-10	HHCS, 1/2-13 X 1	2
90-091-41	HHCS, 1/2-13 X 4 FL THD	2
90-151-06	HHCS, 1/4-20 X 5/8 - SS	13
90-155-52	WASHER, 1/4 SPLIT RING - SS	13
90-155-56	WASHER, #12 FLAT - SS	13
90-219-01	RING, 3/4 EXT RETAIN	1
77-313-03	Pha - Hydraulic Drive	1
59-152-00	Hydraulic Motor	1
59-156-00	Motor Foot Mount	1
68-130-04	Bushing, 1610 X 7/8	1
77-067-00	Plate, 3-Way Cover	1
77-149-00	Plate, Hydraulic Motor Adapter	1
77-800-00	Blank, Hyd Motor Adapter	1
77-204-00	PILOT OPERATED RELIEF VALVE	1
77-205-00	CARTRIDGE BODY	1
77-206-00	HOSE, HYDRAULIC BYPASS	1
77-207-00	HOSE, AEROQUIP 3/4" MATCHMATE	12.5
77-208-00	FITTING, 3/4" JIC CRIMP	2
90-059-62	PLUG, 1/4 NPT*	2
90-218-93	ADAPTER, 3/4 ORB M X 3/4 JIC M - STRAIGHT	2
90-218-99	TEE, 3/4" JIC(M) x 3/4" NPT(M) x 3/4" JIC(M)	1

UTILITY VAC

77-403-H2 Hydraulic Powerpack w/ Pressure Washer

Part Number	Description	Qty
77-310-00	Pha - Power Pack Base Assembly	1
67-006-01	Element, Filter	1
67-020-00	Cap,Filter Element	1
68-130-04	Bushing, 1610 X 7/8	1
68-134-00	Nipple, 3" Npt x 3" Combination Hose	1
68-158-04	Hose Clamp .21-.63"	2
68-158-46	Hose Clamp,3.75-4.63	2
68-158-56	Hose Clamp, 3" Spiral	7
68-160-03	Hose, 3" Vacuum	202
68-160-04	Hose, 4" Vacuum	22
68-164-00	Vacuum Relief	2
68-165-00	1" Grommet	4
68-171-01	Tubing, 1/4" Nylon 6	12
68-172-08	Elbow Comp. Fitting	1
68-172-09	Compression Fitting	1
68-173-01	Terminal Block	8
68-173-02	Fuse Block	5
68-173-04	Fixed Bridge Bar	1
68-173-05	Partition Plate	5
68-173-06	End Clamp	2
68-175-05	Fuse, 5 Amp	5
68-177-02	Gauge, Vacuum	1
68-177-08	Panel Light	1
68-179-01	Switch, 3-Way Moment	1
68-179-02	Switch, 2 Pos Select	1
68-194-04	Label, Dump Switch	1
77-014-01	Silencer	1
77-058-00	Wldmnt, Pwrpck Frame	1
68-037-13	Hpu Spacer	1
68-037-14	Tube, Cyclone Mount	1
68-063-41	Nipple, 3/4 x 3 SS	2
77-058-10	Base Plate	1
77-058-11	Tube, Cyclone Pilar	1
77-058-12	Plate, Pilar Support	1
77-058-13	Bar, Strainer	1
77-058-14	Bar, Drain	1
77-058-15	Angle	4
77-058-16	Din Rail	1
77-058-17	Panel, Din	1
77-058-18	Blower, Side Guard	2
77-058-19	Blower Support Bar	1
77-058-20	Plate, Fuel	1
77-058-21	Filter Plate	1
77-058-22	Filter, Gussets	2
77-058-23	Front Cross Plate	1
77-058-24	Mid Cross Plate	1
77-058-25	Rear Cross Plate	1
77-058-26	Sleeve, Fuel Retainr	1

UTILITY VAC

77-403-H2 Hydraulic Powerpack w/ Pressure Washer

Part Number	Description	Qty
77-070-00	Weldment, Filter	1
68-043-13	Bracket, Filter	1
68-043-16	Rod, Threaded	1
77-070-10	Body, Filter	1
77-070-11	Bottom, Filter	1
77-070-12	Surface, Filter Seal	1
77-070-13	Hinge, Filter	2
77-070-14	Bracket, Latch	6
77-070-15	Tube, Filter Output	1
77-070-16	Tube, Filter Inlet	1
77-070-17	Ring, Filter Guide	1
77-070-18	Tube, Filter Inlet	1
77-178-00	2" Weld On Tank Fitting	2
90-055-07	NUT, 1/4-20 WELD	15
90-075-10	NUT, 3/8-16 WELD	20
77-059-00	Panel, Vac Break	1
77-060-00	Panel, Controls	1
77-061-00	Panel Instructions	1
77-062-00	Panel, Water Drain	1
77-064-00	Wldmnt, Inlet	1
68-034-11	Elbow, 3" 90deg Shrt	1
77-064-10	Nipple, Modified	1
77-064-12	Nipple, 3" NPT x 8" Schd 40	1
77-064-11	3" Dia X 2" Tube	1
77-069-00	Wldmnt, Vac Break Inlet	1
77-069-10	Modified Nipple	1
77-064-12	Nipple, 3" NPT x 8" Schd 40	0.5
77-171-11	Bracket, Nipple Mounting	2
77-071-00	Weldment, Filter Door	1
77-071-10	Door, Filter	1
77-071-11	Hinge, Door	1
77-081-00	Wldmnt, Blwr Tension	1

UTILITY VAC

77-402-01 200 Gallon Spoils Tank

Part Number	Description	Qty
68-405-06	Wand, 3" x 6-1/2' Steel for 3" Hose	1
68-058-06	Weldment, 3" x 6-1/2' Wand	1
68-062-06	Tube, 3" x 6-1/2'	1
RS1042	1010, 3 OD x 18 GA ERW STL TUBE	78
68-071-01	HANDLE, WAND	2
68-205-00	Grip, Handle	2
77-051-00	Coupling, 3" NPT Blk Stl	1
77-311-01	Pha - 200 Gallon Utility Vac Tank	1
68-018-00	Seal, Shutoff	1
68-020-01	Weldment, Cage	1
68-020-10	Bar, Cage	4
68-020-11	Plate, Cage	1
68-026-01	Lid, Shutoff	1
68-801-00	Lid, Shutoff	1
68-106-00	6" Ball	1
68-108-00	Seal, Dump Door	1
68-121-01	Nut, Bulkhead Lock	2
68-123-00	Adapter, -6jic -6orb	2
68-125-00	Knob, Shutoff Lid	1
68-126-00	Door Hinge, Clamp Collar	6
68-153-00	Valve, 3" Ball	1
77-015-01	Chief 2018 Wc Cylind	2
77-034-00	Clamping Handle	4
77-035-00	Bolt, Swing	4
77-072-00	Tank	1
68-012-18	42" Seal Ring	1
68-102-42	Head, 42" Tank	1
77-072-10	Brkt, 42" Tank Hinge	2
77-072-11	42" OD Rolled Cylinder, Seam Welded	1
77-072-12	Brkt, Cylinder Suppo	2
77-072-13	Bracket, Cylinder	2
77-072-14	Bracket, Latch	8
77-072-20	Angle, Tank	2
77-072-21	Support, Tank Side	2
77-072-22	Support, Tank	1
77-072-24	Weldment, Shut-Off	1
68-012-21	Seal, Ring	1
68-105-00	Stud, 1/2-13 x 6 SS	1
77-072-25	Tube, Inlet	1
77-072-26	Head, Inner Shut-Off	1
68-800-00	Head, 16" dia x 3/16" F&D	1
77-072-27	Cylinder, Shut-Off	1
77-072-28	Nipple, 1/2" X 4" Long Threaded One End	1
77-073-00	Wldmnt, 42" Dump Door	1
68-022-10	Brckt, 42" Door Hnge	2
77-073-10	Door, 42" Tank	0
68-802-00	Head, 42" dia. Tank Door	1
77-073-11	Bracket, Door Latch	4
77-073-12	3 X 3.5 Half Nipple	1
77-064-12	Nipple, 3" NPT x 8" Schd 40	0.5
77-073-15	WELDMENT, INLET PIPING	1
77-073-12	3 X 3.5 Half Nipple	1

UTILITY VAC

77-402-01 200 Gallon Spoils Tank

Part Number	Description	Qty
77-074-10	Angle, Rail	1
77-074-11	Angle, Rail	1
77-074-12	Brace, Rail	1
77-074-13	Bar, Rail Pivot	1
77-074-14	Brace, Rail	1
77-075-00	Frame	1
77-075-10	Rail, Left Frame	1
77-075-11	Rail, Right Frame	1
77-075-12	Rail, Frame Base	1
77-075-13	Gusset, Frame	2
77-075-14	Blk, Cylinder Mount	2
77-075-15	Plate, Frame Support	2
77-075-16	Washer, Support	1
77-075-17	Bracket, Blkhd Fttg	1
77-078-00	Hose, Hyd. Assembly	2
77-079-00	Hose, Hyd. Assembly	2
77-115-00	Hpu	1
77-122-00	Fitting, -6jicx-8orb	4
77-123-00	Fitting, Blkhd Tee	2
77-180-00	Bar, Pivot	1
90-051-06	HHCS, 1/4-20 X 5/8	4
90-055-52	WASHER, 1/4 SPLIT RING	4
90-071-15	HHCS, 3/8-16 X 1-1/2	4
90-075-01	NUT, 3/8-16 HEX	4
90-075-52	WASHER, 3/8 SPILT RING	4
90-075-53	WASHER, 3/8 FLAT	8
90-079-91	Pin, Clevis 3/8 x 1-1/4	4
90-091-12	HHCS, 1/2-13 X 1-1/4 PLATED	6
90-095-01	NUT, 1/2-13 HEX	6
90-095-52	WASHER, 1/2 FLAT	6
90-095-58	WASHER, 1/2 LOCK	6
90-136-25	PIN, DOWEL 1 X 2-1/2	2
90-500-05	GRSE.FTG, 1/4-28 STR	4
77-312-20	3" x 20' Suction Hose Assembly	1
67-074-00	Clamp, 3" Wand-End Hose	1

UTILITY VAC

77-402-02 200 Gallon Spoils Tank w/ Hyd Latching Door

Parts Number	Description	Qty
68-405-06	Wand, 3" x 6-1/2' Steel for 3" Hose	1
68-058-06	Weldment, 3" x 6-1/2' Wand	1
68-062-06	Tube, 3" x 6-1/2'	1
68-071-01	HANDLE, WAND	2
68-205-00	Grip, Handle	2
77-051-00	Coupling, 3" NPT Blk Stl	1
77-311-02	Pha - 200 Gal Tank w/Hydraulic Latching Door	1
68-018-00	Seal, Shutoff	1
68-020-01	Weldment, Cage	1
68-020-10	Bar, Cage	4
68-020-11	Plate, Cage	1
68-023-01	Weldment, Yoke	2
68-023-10	Latch, Pull Bar	1
68-023-11	Plate, Latch	2
68-024-00	Cam, Door	2
68-026-01	Lid, Shutoff	1
68-801-00	Lid, Shutoff	1
68-103-00	Cylinder, Door	2
68-106-00	6" Ball	1
68-108-00	Seal, Dump Door	1
68-109-00	Drill Bushing 7/8" Id X 1-1/4" Od X 1-1/2" Lng	2
68-114-00	Cartridge, Flow Divider	1
68-114-01	Aluminum Cartridge Body	2
68-114-02	Plug, Cavity	1
68-121-01	Nut, Bulkhead Lock	2
68-123-00	Adapter, -6jic -6orb	4
68-123-01	Adapter, 3/8 Jic (M) X 5/8" Orb (M)	2
68-123-02	Adapter, 3/8" Jic (M) X 1/2" Orb (M)	4
68-125-00	Knob, Shutoff Lid	1
68-126-00	Door Hinge, Clamp Collar	6
68-132-00	Hydraulic Power Unit	1
68-153-00	Valve, 3" Ball	1
68-179-01	Switch, 3-Way Moment	1
77-015-01	Chief 2018 Wc Cyliind	2
77-074-00	Rail	1
77-074-10	Angle, Rail	1
77-074-11	Angle, Rail	1
77-074-12	Brace, Rail	1
77-074-13	Bar, Rail Pivot	1
77-074-14	Brace, Rail	1
77-075-00	Frame	1
77-075-10	Rail, Left Frame	1
77-075-11	Rail, Right Frame	1

UTILITY VAC

77-402-02 200 Gallon Spoils Tank w/ Hyd Latching Door

Parts Number	Description	Qty
77-073-12	3 X 3.5 Half Nipple	1
77-064-12	Nipple, 3" NPT x 8" Schd 40	0.5
77-073-16	ELBOW, 3" x 45 DEG	1
77-180-00	Bar, Pivot	1
90-051-06	HHCS, 1/4-20 X 5/8	4
90-054-05	SSS, 1/4-20 X 1/2	2
90-055-52	WASHER, 1/4 SPLIT RING	4
77-075-16	Washer, Support	1
77-075-17	Bracket, Blkhd Fttg	1
77-078-00	Hose, Hyd. Assembly	2
77-079-00	Hose, Hyd. Assembly	2
77-122-00	Fitting, -6jicx-8orb	4
77-123-00	Fitting, Blkhd Tee	2
77-153-00	Tank, Hydraulic Latching Door	1
68-012-18	42" Seal Ring	1
68-012-30	Brace, Ring	8
68-012-31	Pivot, Door Cylinder	2
68-012-32	Gusset, Cylinder Mount	1
68-012-34	Pivot, Door Cam	2
68-014-17	Plate, Cylinder Support	2
68-102-42	Head, 42" Tank	1
77-072-10	Brkt, 42" Tank Hinge	2
77-072-11	42" OD Rolled Cylinder, Seam Welded	1
77-072-12	Brkt, Cylinder Suppo	2
77-072-13	Bracket, Cylinder	2
77-072-20	Angle, Tank	2
77-072-21	Support, Tank Side	2
77-072-22	Support, Tank	1
77-072-24	Weldment, Shut-Off	1
68-012-21	Seal, Ring	1
68-105-00	Stud, 1/2-13 x 6 SS	1
77-072-25	Tube, Inlet	1
77-072-26	Head, Inner Shut-Off	1
68-800-00	Head, 16" dia x 3/16" F&D	1
77-072-27	Cylinder, Shut-Off	1
77-072-28	Nipple, 1/2" X 4" Long Threaded One End	1
77-153-10	Gusset, Cylinder/Hose Mount	1
77-154-00	Weldment, 42" Dump Door	1
68-022-10	Brckt, 42" Door Hnge	2
68-022-12	Support, 42" Door Main	2
68-022-13	Support, 42" Door Secondary	1
68-022-14	Support, 42" Door Valve	2
68-022-15	Weldment, Left Hand Latch Housing	1
68-022-16	Plate, Side	2
68-022-17	Bracket, 42" Door Latch	2
68-022-18	Bar, Slide	4
68-022-19	Plate, End	1

UTILITY VAC

77-402-02 200 Gallon Spoils Tank w/ Hyd Latching Door

Parts Number	Description	Qty
68-022-19	Plate, End	1
90-095-12	NUT, 1/2-13 WELD	1
77-073-10	Door, 42" Tank	1
68-802-00	Head, 42" dia. Tank Door	1
77-073-12	3 X 3.5 Half Nipple	1
77-064-12	Nipple, 3" NPT x 8" Schd 40	0.5
77-073-15	WELDMENT, INLET PIPING	1
77-073-12	3 X 3.5 Half Nipple	1
77-064-12	Nipple, 3" NPT x 8" Schd 40	0.5
77-073-16	ELBOW, 3" x 45 DEG	1
77-180-00	Bar, Pivot	1
90-051-06	HHCS, 1/4-20 X 5/8	4
90-054-05	SSS, 1/4-20 X 1/2	2

UTILITY VAC

77-404-12 5' x 12' Trailer w/ Electric Brakes

Parts Number	Description	Qty
68-211-00	Hook, 3/8 Slip	2
68-226-00	Kit, Breakaway	1
68-227-00	Box, Junction	1
68-228-00	Cord, 7 Pole Trailer	1
77-210-00	Weldment, 12' Trailer Frame	1
68-063-12	Plate, Front Rail Support	2
68-063-13	Rod, Chain	2
68-063-36	Bungee Pin	8
68-210-00	Chain, 3/8" Grade 40	80
77-161-29	Plate, Nose	1
77-161-32	Plate, Jack Mounting	1
77-161-38	Bar	2
77-172-01	Weldment, Jack	1
68-179-00	Drop Leg 10k Jack	1
77-172-10	Angle, Jack	2
77-210-01	Beam, Frame Rail	2
77-210-02	Member, Cross	4
77-210-03	Brace, Support	2
77-210-04	Brace	2
77-210-05	Bracket, Left Tail Light	1
77-210-06	Bracket, Right Tail Light	1
77-210-07	Plate, Deck	1
77-210-08	Rack, Storage	4
77-210-09	Tandem Straight Fender w/Back	2
77-210-10	Hanger Kit	1
77-211-00	Axel, 3500 lb. 71.75 x 57.25 Straight	2
77-212-00	Spring Kit	2

UTILITY VAC

77-404-01 Pintle Assembly for Utility Trailers

Parts Number	Description	Qty
68-209-00	Eye, 3" Pintle	1
77-216-00	Kit, Coupler Bolts	1
77-401-01 Strobe		
Part Number	Description	Qty
59-120-00	Light, Strobe	1
68-179-02	Switch, 2 Pos Select	1
68-194-06	Label, Strobe Switch	1
90-901-60	WIRE, 16 GXL x BLACK	15
90-901-71	WIRE, 16 GXL x TAN	15
77-404-02 2-5/16" Ball Assembly for Utility Trailers		
Parts Number	Description	Qty
77-215-00	Coupler, 2-5/16" Flat Mount	1
77-216-00	Kit, Coupler Bolts	1
Accessories		
Parts Number	Description	Qty
Wands Steel:		
68-405-24	.875 by 6-1/2'	
68-405-23	1.25 by 6-1/2'	
68-405-22	2.0 by 6-1/2'	
68-405-21	2.5 by 6-1/2'	
68-405-06	3.0 by 6-1/2'	
68-405-34	.875 by 10'	
68-405-33	1.25 by 10'	
68-405-32	2.0 by 10'	
68-405-31	2.5 by 10'	
68-405-10	3.0 by 10'	
Wands PVC		
68-407-06	3.0 by 6-1/2'	
68-407-08	3.0 by 8'	
68-407-10	3.0 by 10'	

UTILITY VAC

77-401-00 Filter, Cyclonic

Part Number	Description	Qty
68-030-01	Wldmnt, Dust Bin	1
68-030-10	Side, Dust Bin	1
68-030-11	Bottom, Dust Bin	1
68-030-12	Flange, Dust Bin	1
68-136-00	2" Sight Glass Assem	1
68-135-00	Seal, Cyclone	2
68-147-00	Clamp, V-Band	2
68-158-46	Hose Clamp,3.75-4.63	4
68-160-04	Hose, 4" Vacuum	38
77-063-00	Tube, Cyclone Inlet	1
77-065-00	Wldmnt, Cyclone Top	1
68-031-10	Flange, Cyclone Top	1
68-031-12	Tube, 4" Connection	1
68-031-13	Plug, End	1
77-065-10	Tube, Cyclone Inlet	1
77-066-00	Wldmnt, Cyclone	1
68-029-10	Body, Cyclone	1
68-029-11	Cone, Cyclone	1
68-029-12	Inlet, Rect To Round	1
68-029-13	Flange, Cyclone Top	1
68-029-14	Flange, Cyclone Lower	1
68-029-16	Bar, Cyclone Mounting	2
77-209-00	U-Bolt	1
90-091-30	HHCS, 1/2-13 X 3	2
90-095-01	NUT, 1/2-13 HEX	2
90-095-58	WASHER, 1/2 LOCK	2

UTILITY VAC

77-000-16 Swivel TM-7 Utility Vac



UTILITY VAC

77-405-20 20 HP Gasoline Powerpack for Swivel TM Valve Operator/Utility Vac

Part Number	Description	Qty
17-014-00	Strip, Grommet	60
59-053-00	Strap, Filter	1
67-006-01	Element, Filter	1
67-020-00	Cap, Filter Element	1
68-130-04	Bushing, 1610 X 7/8	1
68-134-00	Nipple, 3" Npt x 3" Combination Hose	1
68-153-00	Valve, 3" Ball	1
68-158-56	Hose Clamp, 3" Spiral	6
68-160-03	Hose, 3" Vacuum	170
68-164-00	Vacuum Relief	2
68-171-01	Tubing, 1/4" Nylon 6	12
68-172-08	Elbow Comp. Fitting	1
68-172-09	Compression Fitting	1
68-173-01	Terminal Block	10
68-173-02	Fuse Block	5
68-173-04	Fixed Bridge Bar	1
68-173-06	End Clamp	2
68-175-05	Fuse, 5 Amp	4
68-175-10	Fuse, 10 Amp	1
68-177-02	Gauge, Vacuum	1
68-179-01	Switch, 3-Way Moment	1
68-194-04	Label, Dump Switch	1
77-014-01	Silencer	1
77-016-00	Rain Cap	1
77-064-00	Wldmnt, Inlet	1
68-034-11	Elbow, 3" 90deg Shrt	1
77-064-10	Nipple, Modified	1
77-064-12	Nipple, 3" NPT x 8" Schd 40	1
77-064-11	3" Dia X 2" Tube	1
RS1059	1010, 3 OD x .125 Wall Tubing	2.3
77-071-00	Weldment, Filter Door	1
77-071-10	Door, Filter	1
77-071-11	Hinge, Door	1
77-081-00	Wldmnt, Blwr Tension	1
77-081-10	Bracket, Blwr Tensioner	1
90-075-10	NUT, 3/8-16 WELD	4
90-095-12	NUT, 1/2-13 WELD	2
77-086-00	500 Cfm Blower	1
77-087-00	Wldmnt, Engine Guard	1
77-087-10	Guard, Engine Belt	1
90-055-07	NUT, 1/4-20 WELD	2
77-088-00	Wldmnt, Blower Guard	1
77-088-10	Guard, Blower Side	1
77-088-11	Guard, Blower Front	1
77-089-00	Wldmnt, P.W. Guard	1
77-089-10	Guard, P.W. Outside	1
77-089-11	Guard, P.W. Inside	1
77-093-00	Label, Vacuum	1
77-094-00	Label, Safety	1
77-095-00	Label, Vacuum Break	1
77-106-00	Elbow, 3" Street	2
77-110-00	Sheave, 2/3 V6.50	2
77-111-00	Belt, 2/3vx475	1
77-116-00	Knob, Filter	1
77-139-00	1" Grommet	2
77-148-00	Seal, Filter	1
77-155-00	Plate, Tm-7 Pivot	1
77-156-00	Weldment, Tm-7 Tracking	1

UTILITY VAC

77-405-20 20 HP Gasoline Powerpack for Swivel TM Valve Operator/Utility Vac

Part Number	Description	Qty
77-156-10	Plate, TM-7 Tracking Base	1
77-156-11	Block, TM-7 Right Clamp Mounting	1
77-156-12	Block, TM-7 Left Clamp Mounting	1
77-157-00	Clamp, Tm-7 Lock	2
77-157-10	3" KANT TWIST #410	1
77-158-00	Pin, Clamp Pivot	2
77-159-00	Spacer, Clamp Pivot	2
77-160-00	Label, Warning	2
77-161-01	Weldment, Trailer	1
68-063-12	Plate, Front Rail Support	2
68-063-13	Rod, Chain	2
68-063-41	Nipple, 3/4 x 3 SS	2
68-210-00	Chain, 3/8" Grade 40	80
68-255-07	#12 Axle Hanger	2
77-161-10	Deck, Trailer	1
77-161-11	Deck, Upper Trailer	1
77-161-12	Brace, Trailer	1
77-161-13	Support, Trailer	1
77-161-14	Brace, Swivel	1
77-161-15	Support, Platform	1
77-161-16	Support, Platform Side	1
77-161-17	Support, Platform Side	1
77-161-18	Tubing, Platform	5
77-161-19	Tubing, Hpu Mounting Support	1
77-161-20	Bracket, Fuel Tank	1
77-161-21	Plate, Mid Cross	1
77-161-22	Bracket, Filter	2
77-161-23	Weldment, Pressure Washer Mount	1
77-161-24	Mount, Pressure Washer	1
90-095-12	NUT, 1/2-13 WELD	2
77-161-25	Weldment, Filter	1
68-043-13	Bracket, Filter	1
68-043-16	Rod, Threaded	1
77-070-11	Bottom, Filter	1
77-070-12	Surface, Filter Seal	1
77-070-13		

UTILITY VAC

77-405-27 27 HP Gas Powerpack

Parts Number	Description	Qty
17-014-00	Strip, Grommet	60
59-053-00	Strap, Filter	1
67-006-01	Element, Filter	1
67-020-00	Cap, Filter Element	1
68-130-04	Bushing, 1610 X 7/8	1
68-134-00	Nipple, 3" Npt x 3" Combination Hose	1
68-153-00	Valve, 3" Ball	1
68-158-56	Hose Clamp, 3" Spiral	6
68-160-03	Hose, 3" Vacuum	170
68-164-00	Vacuum Relief	2
68-171-01	Tubing, 1/4" Nylon 6	12
68-172-08	Elbow Comp. Fitting	1
68-172-09	Compression Fitting	1
68-173-01	Terminal Block	10
68-173-02	Fuse Block	5
68-173-04	Fixed Bridge Bar	1
68-173-06	End Clamp	2
68-175-05	Fuse, 5 Amp	4
68-175-10	Fuse, 10 Amp	1
68-177-02	Gauge, Vacuum	1
68-179-01	Switch, 3-Way Moment	1
68-194-04	Label, Dump Switch	1
77-014-01	Silencer	1
77-016-00	Rain Cap	1
77-064-00	Wldmnt, Inlet	1
68-034-11	Elbow, 3" 90deg Shrt	1
77-064-10	Nipple, Modified	1
77-064-12	Nipple, 3" NPT x 8" Schd 40	1
77-064-11	3" Dia X 2" Tube	1
RS1059	1010, 3 OD x .125 Wall Tubing	2.3
77-071-00	Weldment, Filter Door	1
77-071-10	Door, Filter	1
77-071-11	Hinge, Door	1
77-081-00	Wldmnt, Blwr Tension	1
77-081-10	Bracket, Blwr Tensioner	1
90-075-10	NUT, 3/8-16 WELD	4
90-095-12	NUT, 1/2-13 WELD	2
77-086-00	500 Cfm Blower	1
77-087-00	Wldmnt, Engine Guard	1
77-087-10	Guard, Engine Belt	1
90-055-07	NUT, 1/4-20 WELD	2
77-088-00	Wldmnt, Blower Guard	1
77-088-10	Guard, Blower Side	1
77-088-11	Guard, Blower Front	1
77-089-00	Wldmnt, P.W. Guard	1
77-089-10	Guard, P.W. Outside	1
77-089-11	Guard, P.W. Inside	1
77-093-00	Label, Vacuum	1
77-094-00	Label, Safety	1
77-095-00	Label, Vacuum Break	1
77-106-00	Elbow, 3" Street	2
77-110-00	Sheave, 2/3 V6.50	2
77-111-00	Belt, 2/3vx475	1
77-116-00	Knob, Filter	1
77-139-00	1" Grommet	2
77-148-00	Seal, Filter	1
77-155-00	Plate, Tm-7 Pivot	1

UTILITY VAC

77-405-27 27 HP Gas Powerpack

Parts Number	Description	Qty
77-156-10	Plate, TM-7 Tracking Base	1
77-156-11	Block, TM-7 Right Clamp Mounting	1
77-156-12	Block, TM-7 Left Clamp Mounting	1
77-157-00	Clamp, Tm-7 Lock	2
77-157-10	3" KANT TWIST #410	1
77-158-00	Pin, Clamp Pivot	2

UTILITY VAC

77-402-01 200 Gallon Spoils Tank Swivel TM Valve Operator/Utility Vac

Part Number	Description	Qty
68-405-06	Wand, 3" x 6-1/2' Steel for 3" Hose	1
68-058-06	Weldment, 3" x 6-1/2' Wand	1
68-062-06	Tube, 3" x 6-1/2'	1
68-071-01	HANDLE, WAND	2
68-205-00	Grip, Handle	2
77-051-00	Coupling, 3" NPT Blk Stl	1
77-311-01	Pha - 200 Gallon Utility Vac Tank	1
68-018-00	Seal, Shutoff	1
68-020-01	Weldment, Cage	1
68-020-10	Bar, Cage	4
68-020-11	Plate, Cage	1
68-026-01	Lid, Shutoff	1
68-801-00	Lid, Shutoff	1
68-106-00	6" Ball	1
68-108-00	Seal, Dump Door	1
68-121-01	Nut, Bulkhead Lock	2
68-123-00	Adapter, -6jic -6orb	2
68-125-00	Knob, Shutoff Lid	1
68-126-00	Door Hinge, Clamp Collar	6
68-153-00	Valve, 3" Ball	1
77-015-01	Chief 2018 Wc Cylind	2
77-034-00	Clamping Handle	4
77-035-00	Bolt, Swing	4
77-072-00	Tank	1
68-012-18	42" Seal Ring	1
68-102-42	Head, 42" Tank	1
77-072-10	Brkt, 42" Tank Hinge	2
77-072-11	42" OD Rolled Cylinder, Seam Welded	1
77-072-12	Brkt, Cylinder Suppo	2
77-072-13	Bracket, Cylinder	2
77-072-14	Bracket, Latch	8
77-072-20	Angle, Tank	2
77-072-21	Support, Tank Side	2
77-072-22	Support, Tank	1
77-072-24	Weldment, Shut-Off	1
68-012-21	Seal, Ring	1
68-105-00	Stud, 1/2-13 x 6 SS	1
77-072-25	Tube, Inlet	1
77-072-26	Head, Inner Shut-Off	1
68-800-00	Head, 16" dia x 3/16" F&D	1
77-072-27	Cylinder, Shut-Off	1
77-072-28	Nipple, 1/2" X 4" Long Threaded One End	1
77-073-00	Wldmnt, 42" Dump Door	1
68-022-10	Brckt, 42" Door Hnge	2
77-073-10	Door, 42" Tank	0
68-802-00	Head, 42" dia. Tank Door	1
77-073-11	Bracket, Door Latch	4
77-073-12	3 X 3.5 Half Nipple	1
77-064-12	Nipple, 3" NPT x 8" Schd 40	0.5
77-073-15	WELDMENT, INLET PIPING	1
77-073-12	3 X 3.5 Half Nipple	1
77-064-12	Nipple, 3" NPT x 8" Schd 40	0.5
77-073-16	ELBOW, 3" x 45 DEG	1
77-074-00	Rail	1

UTILITY VAC

77-402-01 200 Gallon Spoils Tank Swivel TM Valve Operator/Utility Vac

Part Number	Description	Qty
77-074-10	Angle, Rail	1
77-074-11	Angle, Rail	1
77-074-12	Brace, Rail	1
77-074-13	Bar, Rail Pivot	1
77-074-14	Brace, Rail	1
77-075-00	Frame	1
77-075-10	Rail, Left Frame	1
77-075-11	Rail, Right Frame	1
77-075-12	Rail, Frame Base	1
77-075-13	Gusset, Frame	2
77-075-14	Blk, Cylinder Mount	2
77-075-15	Plate, Frame Support	2
77-075-16	Washer, Support	1
77-075-17	Bracket, Blkhd Fttg	1
77-078-00	Hose, Hyd. Assembly	2
77-079-00	Hose, Hyd. Assembly	2
77-115-00	Hpu	1
77-122-00	Fitting, -6jicx-8orb	4
77-123-00	Fitting, Blkhd Tee	2
77-180-00	Bar, Pivot	1
90-051-06	HHCS, 1/4-20 X 5/8	4
90-055-52	WASHER, 1/4 SPLIT RING	4
90-071-15	HHCS, 3/8-16 X 1-1/2	4
90-075-01	NUT, 3/8-16 HEX	4
90-075-52	WASHER, 3/8 SPILT RING	4
90-075-53	WASHER, 3/8 FLAT	8
90-079-91	Pin, Clevis 3/8 x 1-1/4	4
90-091-12	HHCS, 1/2-13 X 1-1/4 PLATED	6
90-095-01	NUT, 1/2-13 HEX	6
90-095-52	WASHER, 1/2 FLAT	6
90-095-58	WASHER, 1/2 LOCK	6
90-136-25	PIN, DOWEL 1 X 2-1/2	2
90-500-05	GRSE.FTG, 1/4-28 STR	4
77-312-20	3" x 20' Suction Hose Assembly	1
67-074-00	Clamp, 3" Wand-End Hose	1
68-134-00	Nipple, 3" Npt x 3" Combination Hose	1
68-158-56	Hose Clamp, 3" Spiral	1
68-160-03	Hose, 3" Vacuum	240

UTILITY VAC

77-402-02 200 Gallon Spoils Tank w/ Hyd Latching Door Swivel TM Valve Operator/Utility Vac

Parts Number	Description	Qty
68-405-06	Wand, 3" x 6-1/2' Steel for 3" Hose	1
68-058-06	Weldment, 3" x 6-1/2' Wand	1
68-062-06	Tube, 3" x 6-1/2'	1
68-071-01	HANDLE, WAND	2
68-205-00	Grip, Handle	2
77-051-00	Coupling, 3" NPT Blk Stl	1
77-311-02	Pha - 200 Gal Tank w/Hydraulic Latching Door	1
68-018-00	Seal, Shutoff	1
68-020-01	Weldment, Cage	1
68-020-10	Bar, Cage	4
68-020-11	Plate, Cage	1
68-023-01	Weldment, Yoke	2
68-023-10	Latch, Pull Bar	1
68-023-11	Plate, Latch	2
68-024-00	Cam, Door	2
68-026-01	Lid, Shutoff	1
68-801-00	Lid, Shutoff	1
68-103-00	Cylinder, Door	2
68-106-00	6" Ball	1
68-108-00	Seal, Dump Door	1
68-109-00	Drill Bushing 7/8" Id X 1-1/4" Od X 1-1/2" Lng	2
68-114-00	Cartridge, Flow Divider	1
68-114-01	Aluminum Cartridge Body	2
68-114-02	Plug, Cavity	1
68-121-01	Nut, Bulkhead Lock	2
68-123-00	Adapter, -6jic -6orb	4
68-123-01	Adapter, 3/8 Jic (M) X 5/8" Orb (M)	2
68-123-02	Adapter, 3/8" Jic (M) X 1/2" Orb (M)	4
68-125-00	Knob, Shutoff Lid	1
68-126-00	Door Hinge, Clamp Collar	6
68-132-00	Hydraulic Power Unit	1
68-153-00	Valve, 3" Ball	1
68-179-01	Switch, 3-Way Moment	1
77-015-01	Chief 2018 Wc Cy lind	2
77-074-00	Rail	1
77-074-10	Angle, Rail	1
77-074-11	Angle, Rail	1
77-074-12	Brace, Rail	1
77-074-13	Bar, Rail Pivot	1
77-074-14	Brace, Rail	1
77-075-00	Frame	1
77-075-10	Rail, Left Frame	1
77-075-11	Rail, Right Frame	1
77-075-12	Rail, Frame Base	1
77-075-13	Gusset, Frame	2
77-075-14	Blk, Cylinder Mount	2
77-075-15	Plate, Frame Support	2

UTILITY VAC

77-402-02 200 Gallon Spoils Tank w/ Hyd Latching Door Swivel TM Valve Operator/Utility Vac

Parts Number	Description	Qty
77-073-12	3 X 3.5 Half Nipple	1
77-064-12	Nipple, 3" NPT x 8" Schd 40	0.5
77-073-16	ELBOW, 3" x 45 DEG	1
77-180-00	Bar, Pivot	1
90-051-06	HHCS, 1/4-20 X 5/8	4
90-054-05	SSS, 1/4-20 X 1/2	2
90-055-52	WASHER, 1/4 SPLIT RING	4
77-075-16	Washer, Support	1
77-075-17	Bracket, Blkhd Fttg	1
77-078-00	Hose, Hyd. Assembly	2
77-079-00	Hose, Hyd. Assembly	2
77-122-00	Fitting, -6jicx-8orb	4
77-123-00	Fitting, Blkhd Tee	2
77-153-00	Tank, Hydraulic Latching Door	1
68-012-18	42" Seal Ring	1
68-012-30	Brace, Ring	8
68-012-31	Pivot, Door Cylinder	2
68-012-32	Gusset, Cylinder Mount	1
68-012-34	Pivot, Door Cam	2
68-014-17	Plate, Cylinder Support	2
68-102-42	Head, 42" Tank	1
77-072-10	Brkt, 42" Tank Hinge	2
77-072-11	42" OD Rolled Cylinder, Seam Welded	1
77-072-12	Brkt, Cylinder Suppo	2
77-072-13	Bracket, Cylinder	2
77-072-20	Angle, Tank	2
77-072-21	Support, Tank Side	2
77-072-22	Support, Tank	1
77-072-24	Weldment, Shut-Off	1
68-012-21	Seal, Ring	1
68-105-00	Stud, 1/2-13 x 6 SS	1
77-072-25	Tube, Inlet	1
77-072-26	Head, Inner Shut-Off	1
68-800-00	Head, 16" dia x 3/16" F&D	1
77-072-27	Cylinder, Shut-Off	1
77-072-28	Nipple, 1/2" X 4" Long Threaded One End	1
77-153-10	Gusset, Cylinder/Hose Mount	1
77-154-00	Weldment, 42" Dump Door	1
68-022-10	Brckt, 42" Door Hnge	2
68-022-12	Support, 42" Door Main	2
68-022-13	Support, 42" Door Secondary	1
68-022-14	Support, 42" Door Valve	2
68-022-15	Weldment, Left Hand Latch Housing	1
68-022-16	Plate, Side	2
68-022-17	Bracket, 42" Door Latch	2
68-022-18	Bar, Slide	4
68-022-19	Plate, End	1
90-095-12	NUT, 1/2-13 WELD	1
68-022-25	Weldment, Right Hand Latch Housing	1
68-022-16	Plate, Side	2
68-022-17	Bracket, 42" Door Latch	2
68-022-18	Bar, Slide	4

**77-402-02 200 Gallon Spoils Tank w/ Hyd Latching Door
Swivel TM Valve Operator/Utility Vac**

Parts Number	Description	Qty
68-022-19	Plate, End	1
90-095-12	NUT, 1/2-13 WELD	1
77-073-10	Door, 42" Tank	1
68-802-00	Head, 42" dia. Tank Door	1
77-073-12	3 X 3.5 Half Nipple	1
77-064-12	Nipple, 3" NPT x 8" Schd 40	0.5
77-073-15	WELDMENT, INLET PIPING	1
77-073-12	3 X 3.5 Half Nipple	1
77-064-12	Nipple, 3" NPT x 8" Schd 40	0.5
77-073-16	ELBOW, 3" x 45 DEG	1
77-180-00	Bar, Pivot	1
90-051-06	HHCS, 1/4-20 X 5/8	4
90-054-05	SSS, 1/4-20 X 1/2	2
90-055-52	WASHER, 1/4 SPLIT RING	4

77-404-01 Pintle Assembly for Utility Trailers

Parts Number	Description	Qty
68-209-00	Eye, 3" Pintle	1
77-216-00	Kit, Coupler Bolts	1
77-401-01 Strobe		
Part Number	Description	Qty
59-120-00	Light, Strobe	1
68-179-02	Switch, 2 Pos Select	1
68-194-06	Label, Strobe Switch	1
90-901-60	WIRE, 16 GXL x BLACK	15
90-901-71	WIRE, 16 GXL x TAN	15
77-404-02 2-5/16" Ball Assembly for Utility Trailers		
Parts Number	Description	Qty
77-215-00	Coupler, 2-5/16" Flat Mount	1
77-216-00	Kit, Coupler Bolts	1

77-405-00 Swivel Plate and Accessories

Part Number	Description	Qty
77-155-00	Plate, Tm-7 Pivot	1
77-156-00	Weldment, Tm-7 Tracking	1
77-156-10	Plate, TM-7 Tracking Base	1
RS1036	1018, 3/8 x 6 CRS	19.75
77-156-11	Block, TM-7 Right Clamp Mounting	1
RS1035	1018, 1-5/8 x 2 CRS	5.5
77-156-12	Block, TM-7 Left Clamp Mounting	1
RS1035	1018, 1-5/8 x 2 CRS	5.5
77-157-00	Clamp, Tm-7 Lock	2
77-157-10	3" KANT TWIST #410	1
77-158-00	Pin, Clamp Pivot	2
RS221	4340, 3/4 DIA CD	3.13
77-159-00	Spacer, Clamp Pivot	2
RS1037	6061, 7/8 DIA T6 ALUM	1.13
77-160-00	Label, Warning	2
77-168-00	Stop, Tm-7	2
RS1073	A-36, 5 x 3 x 1/4 Stl Angle	3.3
77-175-00	Rubber Bumper	2
77-188-00	Heavy Duty Turntable	1
77-189-00	Radial / Thrust Load Track Rollers	2
77-190-00	Brass Finished Flat Washer	4
77-191-00	One Piece Threaded Clamp On Collar	2
77-201-02	Weldment, Tm-7 Swivel Deck	1
77-161-39	Ring, Rolling	1
77-201-01	Deck, Tm-7 Swivel	1
90-091-15	HHCS, 1/2-13 X 1-1/2	16
90-095-01	NUT, 1/2-13 HEX	16
90-095-52	WASHER, 1/2 FLAT	16
90-095-58	WASHER, 1/2 LOCK	16
Other Accessories:		
77-401-00		
77-401-01		
Wands Steel		
68-405-24	.875 by 6-1/2'	
68-405-23	1.25 by 6-1/2'	
68-405-22	2.0 by 6-1/2'	
68-405-21	2.5 by 6-1/2'	
68-405-06	3.0 by 6-1/2'	
68-405-34	.875 by 10'	
68-405-33	1.25 by 10'	
68-405-32	2.0 by 10'	
68-405-31	2.5 by 10'	
68-405-10	3.0 by 10'	
Wands PVC		
68-407-06	3.0 by 6-1/2'	
68-407-08	3.0 by 8'	
68-407-10	3.0 by 10'	

UTILITY VAC

77-401-00 Filter, Cyclonic

Part Number	Description	Qty
68-030-01	Wldmnt, Dust Bin	1
68-030-10	Side, Dust Bin	1
68-030-11	Bottom, Dust Bin	1
68-030-12	Flange, Dust Bin	1
68-136-00	2" Sight Glass Assem	1
68-135-00	Seal, Cyclone	2
68-147-00	Clamp, V-Band	2
68-158-46	Hose Clamp,3.75-4.63	4
68-160-04	Hose, 4" Vacuum	38
77-063-00	Tube, Cyclone Inlet	1
77-065-00	Wldmnt, Cyclone Top	1
68-031-10	Flange, Cyclone Top	1
68-031-12	Tube, 4" Connection	1
68-031-13	Plug, End	1
77-065-10	Tube, Cyclone Inlet	1
77-066-00	Wldmnt, Cyclone	1
68-029-10	Body, Cyclone	1
68-029-11	Cone, Cyclone	1
68-029-12	Inlet, Rect To Round	1
68-029-13	Flange, Cyclone Top	1
68-029-14	Flange, Cyclone Lower	1
68-029-16	Bar, Cyclone Mounting	2
77-209-00	U-Bolt	1
90-091-30	HHCS, 1/2-13 X 3	2
90-095-01	NUT, 1/2-13 HEX	2
90-095-58	WASHER, 1/2 LOCK	2

UTILITY VAC

ORDERING INFORMATION

To place an order or to get more detailed information on any E.H. Wachs products, call us at:
1-800-323-8185.

ORDERING REPLACEMENT PARTS

Please use parts list provided in manual. Have part description and part number of required replacement part or parts to help expedite order and insure proper parts are being ordered.

REPAIR INFORMATION

Please call E.H. Wachs Company prior to returning any equipment for repair. We will advise you of shipping and handling. Please enclose with equipment to be repaired your name, address, phone number and a brief description of problem or work to be done or estimated.

All repair work done at our plant will be estimated and the customer advised of cost and time required to complete repair.

WARRANTY INFORMATION

Enclosed with the manual is a warranty card. Please fill out the registration card and return to E.H. Wachs. Retain the owners registration record and warranty card for your information.

RETURN GOODS ADDRESS

E.H. Wachs Company
100 Shepard Street
Wheeling, Illinois 60090

Call or Write:

E.H. Wachs Company
100 Shepard Street
Wheeling, Illinois 60090

847-537-8800

FAX: 847-520-1147 • 847-520-1168

Toll-Free: 1-800-323-8185

www.wachsco.com



PIPE & VALVE

MAINTENANCE PRODUCTS

Mod. 77-000-02 S/N:

Enter your machine's serial number here for proper record keeping and ordering reference.