

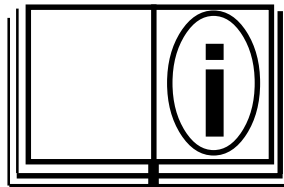



**WACHS HTM-5D  
POWER UNIT  
MODEL 14-000-32**



	<b>HYDRAULIC TOOL</b>
	<b>POWER UNITS</b>
Model <b>HTM-5D</b> Ser.No.	<input type="text"/> <input type="text"/> <input type="text"/> <input type="text"/> <input type="text"/> <input type="text"/> <input type="text"/>
E.H. WACHS COMPANIES 100 Shepard St. Wheeling Il. 60090	

**Part Number:** 14-MAN-32

**Revision No:** 1

Revised:  
April, '98



# WACHS HTM 5D POWER UNIT

## TABLE OF CONTENTS

SECTION I	STANDARD EQUIPMENT.....	4
SECTION II	SPECIFICATIONS.....	5
SECTION III	SAFETY.....	6
SECTION IV	SET-UP AND OPERATING PROCEDURES.....	7-12
SECTION V	MAINTENANCE.....	13-14
SECTION VI	TROUBLE SHOOTING.....	15-19
SECTION VII	PARTS LISTS AND EXPLODED VIEW DRAWINGS.....	21-25
SECTION VIII	ORDERING INFORMATION.....	26



# WACHS HTM 5D POWER UNIT

## SECTION III

## STANDARD EQUIPMENT

The E.H. WACHS **HTM-5D** series power unit is designed to provide hydraulic flow and pressure for operation of H.T.M.A. type 1 & 2 hydraulic tools. The unit provides power for operation of type 1 or 2 open center tools ( 5-10 GPM/ 19-38 LPM @ 2000 PSI/ 140 BAR ). If equipped with the optional combiner kit, the two circuits can be combined into one 10 GPM / 38 LPM circuit for operation of H.T.M.A. type 3 tools.



The power unit may be equipped with gas engines ranging 9 hp to 18 hp, or diesel engines ranging from 18 hp to 20 hp. See the parts section to determine which this unit has. The power units are all equipped with air -to-oil coolers with suction fan mounted to the power shaft on the engine.

All engine compartments are open for easy maintenance and repair of the engine.

The fuel and hydraulic systems are self contained with the required reservoir, filtration and level indicators.

Your HTM-5d Power Unit is equipped with the following features:

- Torsion Bar rubber mounted axle for ease and comfort of towing.
- Multiple axle positioning for optimum load capacity
- Large diameter wheels for ease in towing over rough terrain.
- Full instrumentation to monitor engine operation.
- Large lockable tool storage area.
- May be equipped with an air compressor (optional).
- Sound suppression material to reduce noise level.
- Large capacity hydraulic cooler will extend unit life and offer operator comfort. The cooling capacity meets or exceeds HTMA specifications.

**NOTE:** *Not all power units can be equipped with the optional dual circuits or combiner kit. Check with the dealer for details.*

# WACHS HTM 5D POWER UNIT

## SECTION III

## SPECIFICATIONS



<b>MODEL:</b>	<b>HCM-5D # 14-000-32</b>			
<b>HYDRAULIC SYSTEM:</b>	OPEN/CLOSED CENTER			
<b>FRAME TYPE:</b>	TRAILER MOUNT			
<b>LENGTH:</b>	<b>120"</b> 304 CM			
<b>WIDTH:</b>	<b>62"</b> 157.5 CM			
<b>HEIGHT:</b>	<b>49"</b> 124.5 CM			
<b>WEIGHT (DRY):</b>	<b>1300lbs</b> 590kg			
<b>FILTRATION:</b>	10 MICRON RETURN RETURN			
<b>OIL COOLER:</b>	AIR TO OIL WITH INDEPENDENT FAN			
<b>MOTOR:</b>	10 HP 220VOLT 3 PHASE BALDOR ELECTRIC MOTOR			
<b>FUEL:</b>	N/A			
<b>HYDRAULIC OIL:</b>	5GALLONS/18.9 LITRES			
<b>RATED FLOW:</b>	<b>GPM @ PSI      LPM @ BAR</b>			
<b>A PORT:</b>	<b>8.0</b>	<b>2000.0</b>	<b>33.3 0</b>	
<b>B PORT:</b>				
<b>C PORT:</b>				
<b>HYDRAULIC RELEIF PRESSURE:</b>	<b>2100 PSI @ 138.0 BAR</b>			

# WACHS HTM 5D POWER UNIT

## SECTION III

## SAFETY INSTRUCTIONS

The E. H. Wachs Company takes great pride in manufacturing safe, quality products with user safety a priority.

The E.H. Wachs Company recommends that all users comply with the following safety rules and instructions when operating our equipment. For your safety and the safety of others, read and understand these safety recommendations and operating instructions before operating.

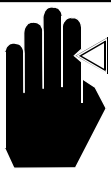

### Read the Following thoroughly before proceeding.

	<b>CAUTION</b> DO NOT attempt to locate hydraulic leaks by feeling around hoses and fittings with bare hands. "Pin-hole" leaks can penetrate the skin.
--	---

#### ALWAYS WEAR PROTECTIVE EQUIPMENT:

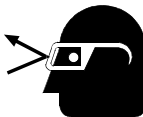
	<b>WARNING</b> Impact resistant eye protection must be worn while operating or working near this tool.
---	---

For additional information on eye and face protection, refer to federal OSHA regulations, 29 Code of Federal Regulations, Section 1910.133., Eye and Face Protection and American National Standards Institute, ANSI Z87.1, Occupational and Educational Eye and Face Protection. Z87.1 is available from the American National Standards Institute, Inc., 1430 Broadway, New York, NY 10010.

	<b>CAUTION</b> Personal hearing protection is recommended when operating or working near this tool.
--	--

Hearing protectors are required in high noise areas, 85 dBA or greater. The operation of other tools and equipment in the area, reflective surfaces, process noises and resonant structures can substantially contribute to and increase the noise level in the area. For additional information on hearing protection, refer to federal OSHA regulations, 29 Code of Federal Regulations, Section 1910.95, Occupational Noise Exposure and ANSI S12.6 Hearing Protectors.

	<b>ATTENTION</b> This safety symbol appears in these instructions to identify an action that could cause bodily injury to the operator or other personnel.
--	---

1. **READ THE OPERATING MANUAL!!** Reading the setup and operating instructions prior to beginning the setup procedures can save valuable time and help prevent injury to operators or damage to machines.
2. **INSPECT MACHINE & ACCESSORIES!** Prior to machine setup physically inspect the machine and it's accessories. Look for worn tool slides, loose bolts or nuts, lubricant leakage, excessive rust, etc. A properly maintained machine can greatly decrease the chances for injury.
3. **ALWAYS READ PLACARDS & LABELS!** All placards, labels and stickers must be clearly legible and in good condition. Replacement labels can be purchased from the manufacturer.
4. **KEEP CLEAR OF ROTATING PARTS!** Keep hands, arms and fingers clear of all rotating or moving parts. Always turn machine off before attempting any adjustments requiring contact with the machine or it's accessories.
5. **SECURE LOOSE CLOTHING & JEWELRY!** Loose fitting clothing, jewelry; long, unbound hair can get caught in the rotating parts on machines. By keeping these things secure or removing them you can greatly reduce the chance for injury.
6. **KEEP WORK AREA CLEAR!** Be sure to keep the work area free of clutter and nonessential materials. Only allow those personnel directly associated with the work being performed to have access to the area if possible.

# WACHS HTM 5D POWER UNIT

## SECTION III

## SAFETY INSTRUCTIONS

The safety tag at the right is attached to the power unit when shipped from the factory. Read and understand the safety instructions listed on this tag before removal. We suggest you retain this tag and attach it to the power unit when not in use.

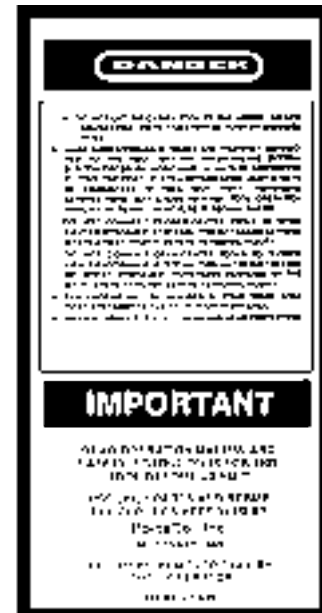
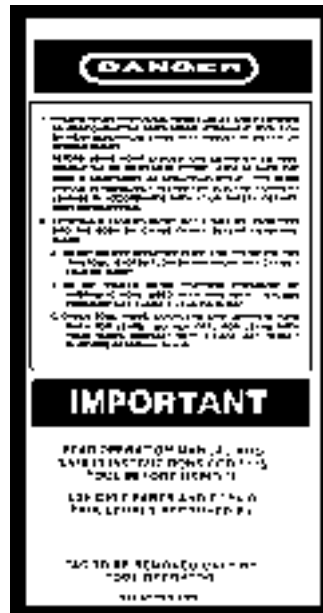

### SAFETY SYMBOLS:

Safety symbols are used to emphasize all operator maintenance and repair actions which, if not strictly followed, could result in a life-threatening situation, bodily injury or damage to equipment.

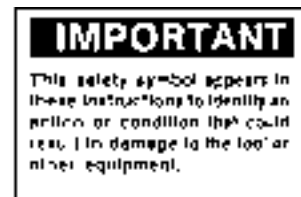
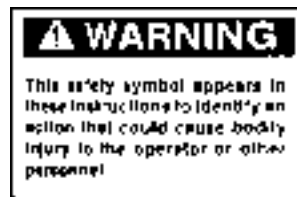

### NOTE:

**ALWAYS OBSERVE SAFETY SYMBOLS! THEY ARE INCLUDED FOR YOUR SAFETY AND FOR THE PROTECTION OF THE POWER UNIT.**

# WACHS HTM 5D POWER UNIT

SECTION IV

## **SET-UP AND OPERATING PROCEDURES**

# WACHS HTM 5D POWER UNIT

## • HYDRAULIC SYSTEM DESCRIPTION

The hydraulic system consists of a hydraulic fluid reservoir, filter assembly, single or optional tandem pump, and a wide variety of flow controls. The filter element is a "spin on" type element for easy replacement. The filter housing has a pressure bypass valve to divert fluid directly to the tank in the event of a restricted filter.

Hydraulic pumps will vary depending upon the capabilities of the specific power unit. The hydraulic pump(s) will be illustrated and called out in the parts section of this manual.

Pressure hoses from the pump are connected directly to a control module which contains a relief valve, a flow control valve, and a pressure and return port. Optional control modules may contain additional valves and ports.

The following fluids work well over a wide temperature range at startup, allow moisture to settle out, and resist biological growth likely in cool operating hydraulic circuits. These fluids are recommended by the E.H. WACHS CO. Other fluids that meet or exceed the specifications of these fluids may also be used.

Ams-oil hydraulic fluid A/W 150 ssu, 100 v.i.

Chevron AW-MV-32

Exxon "Univis" J-26

## HYDRAULIC FLUID REQUIREMENTS

The power unit is shipped from the factory **WITHOUT** the necessary operating fluids. Fluids meeting the specifications below, however, will provide good all-season operation if normal maintenance is performed ( I.E, periodic filter changes, draining of condensate, etc. )

### VISCOSITY ( fluid thickness )

#### USA

50 deg. F	450 ssu max.
100 deg. F	130-200 ssu
140 deg. F	85 ssu min.

#### METRIC

10 deg. C	95 centistokes
38 deg. C	27-42 C.S.
60 deg. C	16.5 C.S. min.

**POUR POINT:** -10 deg. F ( -23 deg. C ) min. for cold start.

**VISCOSITY INDEX:** ( ASTM D 2220 ) 140 min.

**DEMULSIBILITY:** ( ASTM D 1401 ) 30 min. maximum

**FLASH POINT:** ( ASTM D-92 ) 340 deg. F ( 171 deg. C )

# WACHS HTM 5D POWER UNIT

Mobil D.T.E. 13

Gulf " Harmony " AW-HVI-150-32

Shell " Tellus " T-32

Sun " Sunvis " 805 mg.

Texaco " Rando" HD-AZ

- **FUEL SYSTEM DESCRIPTION**

The fuel system consists of a fuel tank, fuel pump, and a filter.

Fuel is pumped from the tank by an engine-mounted fuel pump. Fuel leaving the pump passes through a canister-type, engine mounted fuel filter. The fuel filter element is removeable. The output side of the filter housing is connected, via a hose.

- **FUEL REQUIREMENTS**

Due to the variety of engines used, you must check the engine manual for recommended fuels. A manual is provided with each unit.

- **ENGINE DESCRIPTION**

An engine owner's manual is provided with the power unit. This manual lists the recommended service intervals. It should be followed to ensure proper power unit maintenance.

- **TOOL HOSE RECOMMENDATIONS**

The hoses in the chart (TABLE 1) below are recommended for the hydraulic fluids specified in the section concerning hydraulic fluids.

**TABLE 1. HYDRAULIC HOSE RECOMMENDATIONS**

# WACHS HTM 5D POWER UNIT

## 2. PREPARATION FOR USE

The following checks must be made prior to operating the power unit.

### 1. ENGINE CRANKCASE OIL LEVEL.

#### **IMPORTANT**

ALWAYS CHECK THE OIL LEVEL IN THE ENGINE CRANKCASE BEFORE STARTING THE ENGINE.

Check that the crankcase oil level is at the "FULL" mark on the dipstick.

### 2. HYDRAULIC OIL.

The hydraulic tank is empty prior to shipment from the factory. Add oil prior to operating power unit.

#### **IMPORTANT**

NEVER START THE ENGINE ON A NEW POWER UNIT WITHOUT FIRST CHECKING THE OIL LEVEL IN THE HYDRAULIC TANK. SEVERE PUMP DAMAGE CAN RESULT IF THE OIL LEVEL IS TOO LOW.

### 3. FUEL LEVEL.

The power unit is shipped with only a small amount of fuel for safety purposes. The engine has been run at the factory to purge all air from the fuel system. To prevent air from entering the system, always fill the fuel tank before starting the engine.

### 4. BATTERY.

Check the electrolyte level in each battery cell. The level should never be below the top of the plates. If the level is low, add distilled water. The level is correct when filled to the bottom of the split ring in each cell.

Check that the battery cables are clean and tight so that the charging circuit will function properly.

### 5. TIRES.

Check the air pressure in the tires. See recommended air pressures on the sides of tires.

### 6. LOOSE ITEMS SHIPPED WITH NEW UNITS.

Keep the engine reference manual in an area that is accessible to the operator and maintenance personnel.

- Engine tool kit (If required )
- Engine owner's manual

### 7. HYDRAULIC CONNECTIONS.

Pressure and return hoses are connected to the ports at the control panel as shown on the following page in figure 1.

The pressure and return ports are marked with a decal. When installing couplers, the pressure port receives the male coupler and the return port receives the female coupler.

The hoses can then be connected directly to the couplers. Couplers are available through your local WACHS dealer.

# WACHS HTM 5D POWER UNIT

FIGURE 1. HYDRAULIC CONNECTIONS

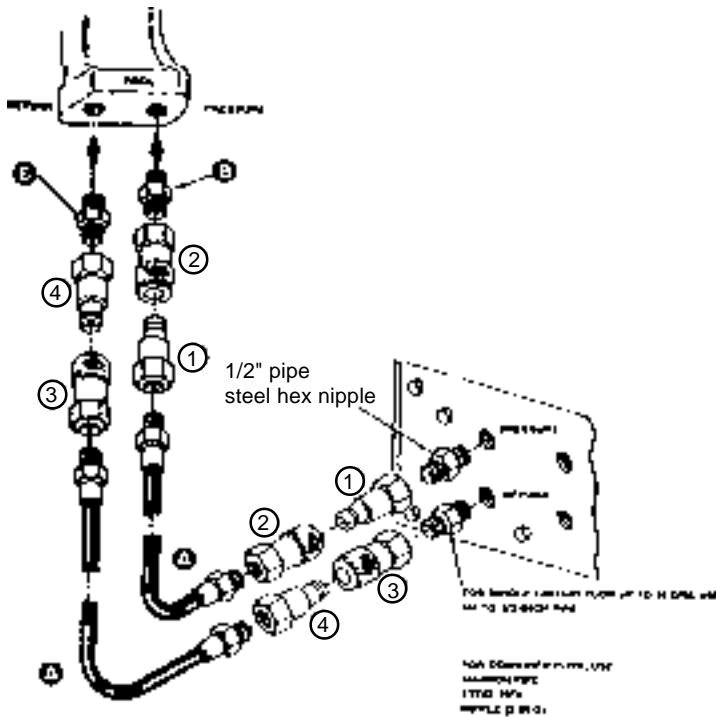

- A. Refer to table 1. for hose recommendations.
- B. Use adaptors with threads that match tool part.

## IMPORTANT

WHEN USING COUPLERS, OIL SHOULD ALWAYS FLOW FROM THE MALE COUPLER TO THE FEMALE COUPLER.

- 1. H.T.M.A. 3/8" male quick acting coupler with 1/2" npt thread.
- 2. H.T.M.A. 3/8" female quick acting coupler with 1/2" npt thread. At the tool this may be H.T.M.A. 3/8" female quick acting coupler with 3/8" npt thread.

### \*FOR SINGLE CIRCUIT FLOW UP TO 10 GPM \*

- 3. H.T.M.A. 3/8" female quick acting coupler with 1/2" npt thread.
- 4. H.T.M.A. 3/8" male quick acting coupler with 1/2" npt thread. At the tool this may be H.T.M.A. 3/8" male quick acting coupler with 3/8" npt thread.

# WACHS HTM 5D POWER UNIT

## 3. OPERATING INSTRUCTIONS

### 1. BEFORE START UP

Perform the checks specified in section 2., before operating the power unit. Make certain the following conditions are met.

- Engine oil level is at the "FULL" mark on the dipstick. Add oil as required. Refer to the section 1 for fuel requirements.
- Hydraulic tank must be full.
- Check that fuel level is adequate for estimated operating time. On diesels, allowing the fuel tank to run dry will cause air to enter the injection system. The system must then be bled.
- All hoses are to be free of damage. All hose and coupler fittings must be tight.
- The front section of the engine must be free of leaves, dirt, and other debris that may inhibit cooling or create a fire hazard.

### 2. START UP

- A. Make sure the flow control circuit is set at 0 or off.
- B. Connect the hydraulic hoses to the applicable couplers on the control panel. Male couplers are pressure ports. Female couplers are return ports.
- C. Check that the hoses are properly connected to the tool and that the tool is in the off or deactivated mode.
- D. Pull the throttle knob out slightly, then turn the ignition key to start the engine. Allow the engine to run at a low speed until the engine and the hydraulic circuits are warm.

### 3. COLD WEATHER START UP

Some power units may be equipped with an optional cold start kit. To use the optional cold start kit, proceed as follows:

- A. Press the cold start button for 15 to 20 seconds.
- B. Turn the ignition key to start the engine.
- C. If the engine fails to start, turn the ignition key to off and press the cold start button for an additional 15 to 20 seconds. Turn the ignition key to start the engine.

#### **IMPORTANT**

DO NOT CONTINUOUSLY CRANK THE ENGINE FOR LONGER THAN 15 SECONDS AT ONE TIME. ALLOW AT LEAST ONE MINUTE FOR THE STARTER TO COOL BETWEEN START ATTEMPTS.

### 4. TOOL OPERATION

- A. Start the engine as specified in paragraphs 2 and 3.
- B. Turn the hydraulic circuit to the on position or a flow setting to start fluid flowing to the tool.
- C. For units having an optional flow combiner kit, the two 5 GPM/ 19 LPM circuits combined into one 10 GPM/ 38 LPM circuit for operation of H.T.M.A. type 3 tools.

# WACHS HTM 5D POWER UNIT

To obtain 10 GPM/ 38 LPM, attach the pressure hose to the center port with all flow circuits in the off position. The return hose may be attached to either return port. Turn on the 10 GPM / 38 LPM circuit to start the flow.

NOTE: Both 5GPM / 19 LPM circuits remain in the off position for 10 GPM / 38 LPM flow.

## 5. SHUT DOWN

- A. Push throttle knob in.
- B. Return the hydraulic circuit to the off position or 0 flow.
- C. Turn the ignition key to off. If the power unit is equipped with a diesel engine you must also pull out the stop knob.
- D. Disconnect the hydraulic hoses and store in a suitable area.

### IMPORTANT

- WHEN STORING HOSES, THE COUPLERS AT THE HOSE ENDS SHOULD BE CONNECTED TOGETHER TO PREVENT CONTAMINANTS FROM ENTERING THE HYDRAULIC SYSTEM.
- DO NOT STORE THE HOSES IN DIRECT SUNLIGHT OR IN EXCEPTIONALLY WARM SPACES. EXPANSION OF THE FLUID CAN CAUSE A PRESSURE BUILDUP INSIDE THE HOSES.

# WACHS HTM 5D POWER UNIT

## 4. MAINTENANCE INSTRUCTIONS

### 1. HYDRAULIC SYSTEM MAINTENANCE.

Observe the following for maximum performance and service life from the hydraulic system.

- Use the correct hydraulic fluid at all times.
- Keep the hydraulic system and fluids clean at all times.
- Keep water out of the fluid.
- Keep air out of the lines. Air is indicated by the hydraulic system overheating and foam at the hydraulic tank breather. Tighten all suction line fittings and clamps.
- Hydraulic system wear is noted by increased heat during tool operation, reduced tool performance and eventual system breakdown.

A. Remove condensed moisture from the hydraulic fluid. Condensation is a frequent problem with cool mobile hydraulic circuits. This condition occurs in moist or cold climates when warm air in the reservoir tank draws moisture from the cooler outside air. Water will then accumulate in the tank.

#### IMPORTANT

WATER IN THE FLUID REDUCES LUBRICATION AND CAUSES PREMATURE PARTS WEAR. PUMP CAVITATION MAY ALSO OCCUR.

Approximately once each week ( less often in hot dry weather ) take a small sample from the bottom of the hydraulic tank by removing the 1/2" npt drain plug. If clear water appears, drain the tank until clean oil starts to show.

If fluid is milky, allow it to settle for about 48 hours. before draining. 1% water in a 2000 psi / 140 bar system can cause a 25% increase in wear rate. 16

B. Check suction hose. Check hose from the hydraulic tank to the pump inlet to see that it is not kinked and that the clamps are secure. This will reduce the risk of pump cavitation and sucking air into the system. All pump fittings must be tight.

C. Check hydraulic lines and fittings. Check for loose fittings, leaks, etc., through out the entire hydraulic circuit.

D. Change the hydraulic filter. if the operator consistently connects the hose ends together when detached from the tool and wipes off contaminants before connecting quick disconnects, the filter element should provide maximum performance.

**NOTE:** See dealer for air filter replacement specs.

E. Fill the hydraulic tank. Fill the hydraulic tank by removing the filler cap at the top center of the tank. The tank is full when oil appears in the perforated basket at the bottom of the filler pipe.

**NOTE:** Do not use fluids other than those specified with in this manual.

### 2. ENGINE MAINTENANCE

See engine manual for maintenance requirements.

# WACHS HTM 5D POWER UNIT

## 5. TESTING AND TROUBLE SHOOTING

### 1. GENERAL.

The hydraulic system and engine should be tested periodically to insure that the power unit is operating at peak efficiency.

Performing the recommended tests will help to isolate problems that may exist in the engine and hydraulic system.

The following pages list some of the more frequently encountered problems that may arise and the possible solutions.

# WACHS HTM 5D POWER UNIT

## TESTING AND TROUBLESHOOTING

### 1. TESTING THE HYDRAULIC CIRCUIT

Test the hydraulic circuit as follows: use the Wachs #T-00016-XX-0 hydraulic Tester.

- A. Set the hydraulic circuit to the OFF or 0 flow position.
- B. Connect hydraulic hoses to the appropriate connectors on the control panel for the circuit being tested. Connect the tester to the opposite end of the hoses. Make sure flow direction is correct.
- C. Start the motor and allow the hydraulic fluid to warm to about 100 F/ 38 C.
- D. Open the tester restrictor valve completely. This represents minimum load.
- E. Set the applicable hydraulic circuit to ON, or flow being tested.
- F. Check the flow rate and pressure on the tester gauges. Record the flow and pressure. The flow should be slightly over the unit's rated flow. The pressure gauge will indicate tool back pressure.
- G. Slowly close the restrictor valve on the tester while observing the flow and pressure gauges.
- H. As the system relief valve begins to open and bypass fluid through the valve, the flow rate will drop. At this time, the pressure in the system should be between 2100 and 2200 PSI / 148 and 155 BAR.
- I. If the pressure is not as specified, the hydraulic circuit relief valve must be adjusted or replaced. Turn the adjustment clockwise to increase the pressure setting.

- J. Any drop in flow of more than 1.2 GPM / 4.5 LPM of that recorded in step " F" would indicate wear inside the hydraulic pump or control valve. Changes in hydraulic flow can be analyzed as follows:

If the pressure stabilizes between 2100 and 2200 PSI / 148 and 155BAR, and the flow rate begins to drop, the relief valve is opening and the system is operating properly.

If the flow rate gradually decreases while system pressure increases, the pump or control valve may be worn.

# WACHS HTM 5D POWER UNIT

<b>PROBLEM:</b>	<b>CAUSE:</b>	<b>REMEDY:</b>
STARTER WILL NOT CRANK ENGINE:	ENGINE WORKING AGAINST THE HYDRAULIC PUMP PRESSURE	BE SURE THE CURCUIT SWITCHES ARE <b>OFF</b> .
	BATTERY DISCHARGED OR NOT PROPERLY CONNECTED.	CHECK CONDITION OF BATTERY, CABLE CONNECTIONS, ETC. RE-PLACE AS NECESSARY.
	STARTER DEFECTIVE.	INSPECT STARTER. REPLACE AS NECESSARY.
	IGNITION SWITCH OR SOLENOID SWITCH (ES) DEFECTIVE.	REPLACE AS NECESSARY.
ENGINE CRANKS BUT WILL NOT START:	AIR INJECTORS AND / OR INJECTOR PUMP.	BLEED INJECTORS. REFER TO ENGINE MANUAL.
	WATER IN FUEL.	EMPTY WATER SEDIMENT TRAP. BLEED INJECTORS PER MANUAL .
	COLD START NOT FUNCTIONING	CHECK CURRENT TO GLOW PLUGS ON COLD START UNITS. REPAIR CIRCUIT OR REPLACE GLOW PLUG AS NECESSARY.
	INADEQUATE COMPRESSION	CHECK FOR CLOGGED AIR CLEANER, VALVES SEATED, CYLINDER COMPRESSION LOSS, REPAIR AS REQUIRED.
ENGINE RUNS BUT HYDRAULIC CIRCUIT WILL NOT DRIVE TOOLS.	CIRCUIT SELONOID SWITCHES OFF OR DEFECTIVE.	SET SWITCHES TO ON. REPLACE IF SWITCH DEFECTIVE.
	TOOL NOT CONNECTED TO POWER UNIT.	CONNECT TOOL, CHECK COUPLERS
	HYDRAULIC FLUID RESERVOIR LOW.	CHECK AND FILL AS REQUIRED.
	TOOL HOSES BLOCKED.	REMOVE OBSTRUCTION.
	TOOL HOSES INCORRECTLY CONNECTED TO CIRCUIT FITTINGS	CHECK THAT TOOL HOSE GOES FROM TOP PORT TO TOOL PRES-SURE OR IN PORT, AND FROM TOOL RETURN OR OUT PORT TO LOWER PORT, BOTH PORTS ARE ON THE SAME SIDE OF MANIFOLD.
	RELIEF VALVE(S) STUCK OPEN	ADJUST OR REPLACE.
	TOOL IS DEFECTIVE	REPAIR AS NECESSARY.

# WACHS HTM 5D POWER UNIT

<b>PROBLEM:</b>	<b>CAUSE:</b>	<b>REMEDY:</b>
TOOLS RUN TOO HOT	RELIEF VALVE SET TOO LOW	ADJUST FOR 2100 PSI/148 BAR CRACKING PRESSURE.
	HOSES TOO SMALL	INCREASE HOSE DIAMETER (REFER TO SECTION 1.)
	IMPROPER FLUID	REPLACE FLUID ( REFER TO SECTION 1. )
	COOLER CLOGGED, BLOCKED AIR FLOW.	CLEAN COOLER, STRAIGHTEN FINS AS NECESSARY.
	AIR INJECTORS AND / OR INJECTOR PUMP.	BLEED INJECTORS. REFER TO ENGINE MANUAL.
	THERMAL DIVERTER VALVE DEFECTIVE.	CHECK THAT VALVE IS DIRECTING HOT OIL TO THE COOLER BY FEELING THE TUBING AT THE COOLER. REPLACE VALVE IF DEFECTIVE
	COLD START NOT FUNCTIONING	CHECK CURRENT TO GLOW PLUGS ON COLD START UNITS. REPAIR CIRCUIT OR REPLACE GLOW PLUG AS NECESSARY.
	HYDRAULIC PUMP DAMAGED	REPLACE.
	AIR FLOW THROUGH POWER UNIT BLOCKED	REMOVE OBSTRUCTION
	FAN BELT LOOSE OR BROKEN	REPLACE OR ADJUST AS REQUIRED
	FLOW CONTROL VALVES OR PRIORITY VALVES HAVE BEEN ADDED TO THE CIRCUIT	SOME ROTARY TOOLS MUST HAVE FLOW CONTROLS. ADJUST FLOW TO MATCH TOOL GPM TO AVOID FORCING EXCESS FLOW OVER THE RELIEF
CLOSED CENTER TOOLS IN USE	USE ONLY OPEN CENTER TOOLS	

# **WACHS HTM 5D POWER UNIT**

## **EXPLODED VIEW DRAWINGS & PARTS LISTS**

# WACHS HTM 5D POWER UNIT

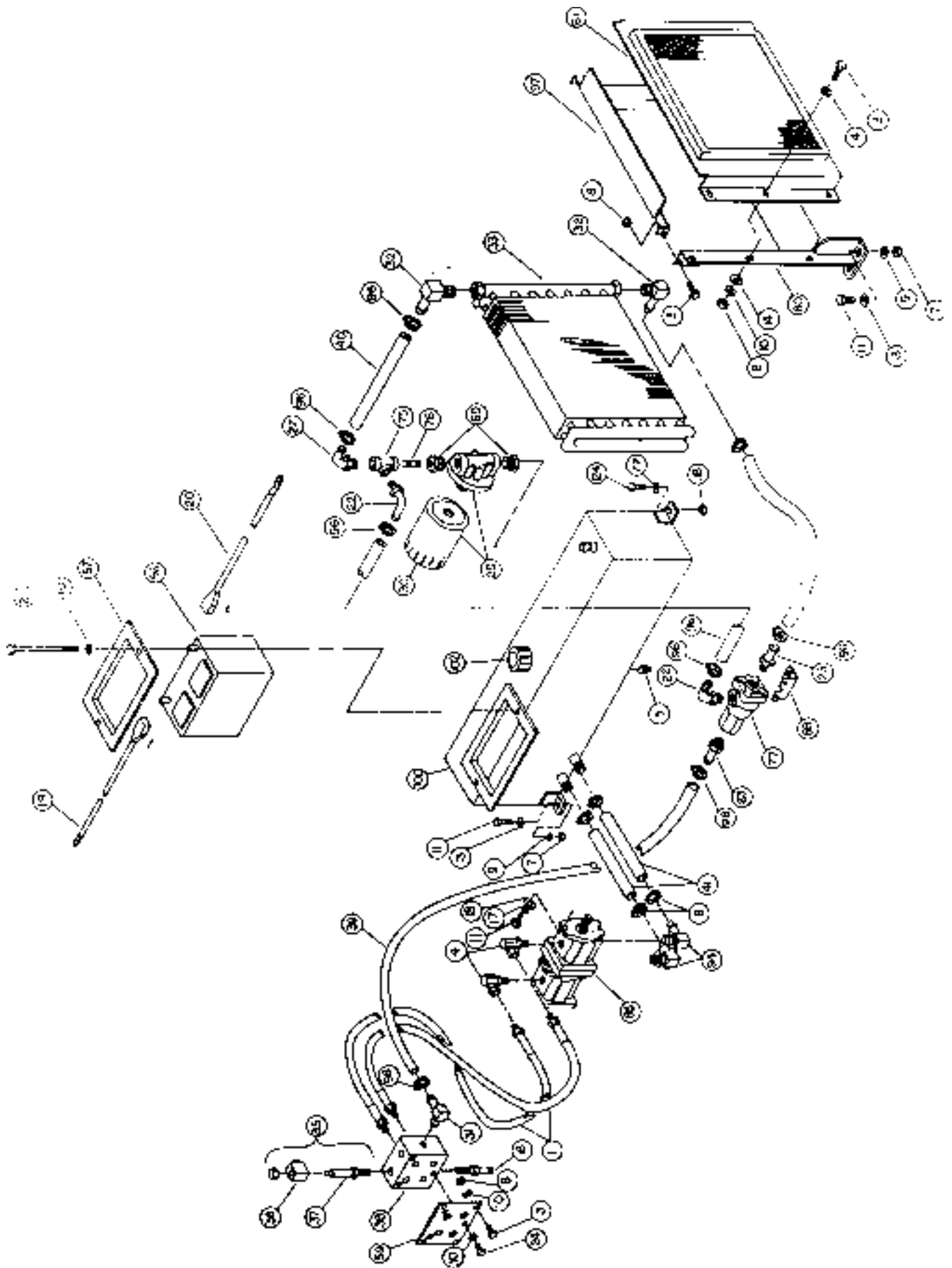

# WACHS HTM 5D POWER UNIT

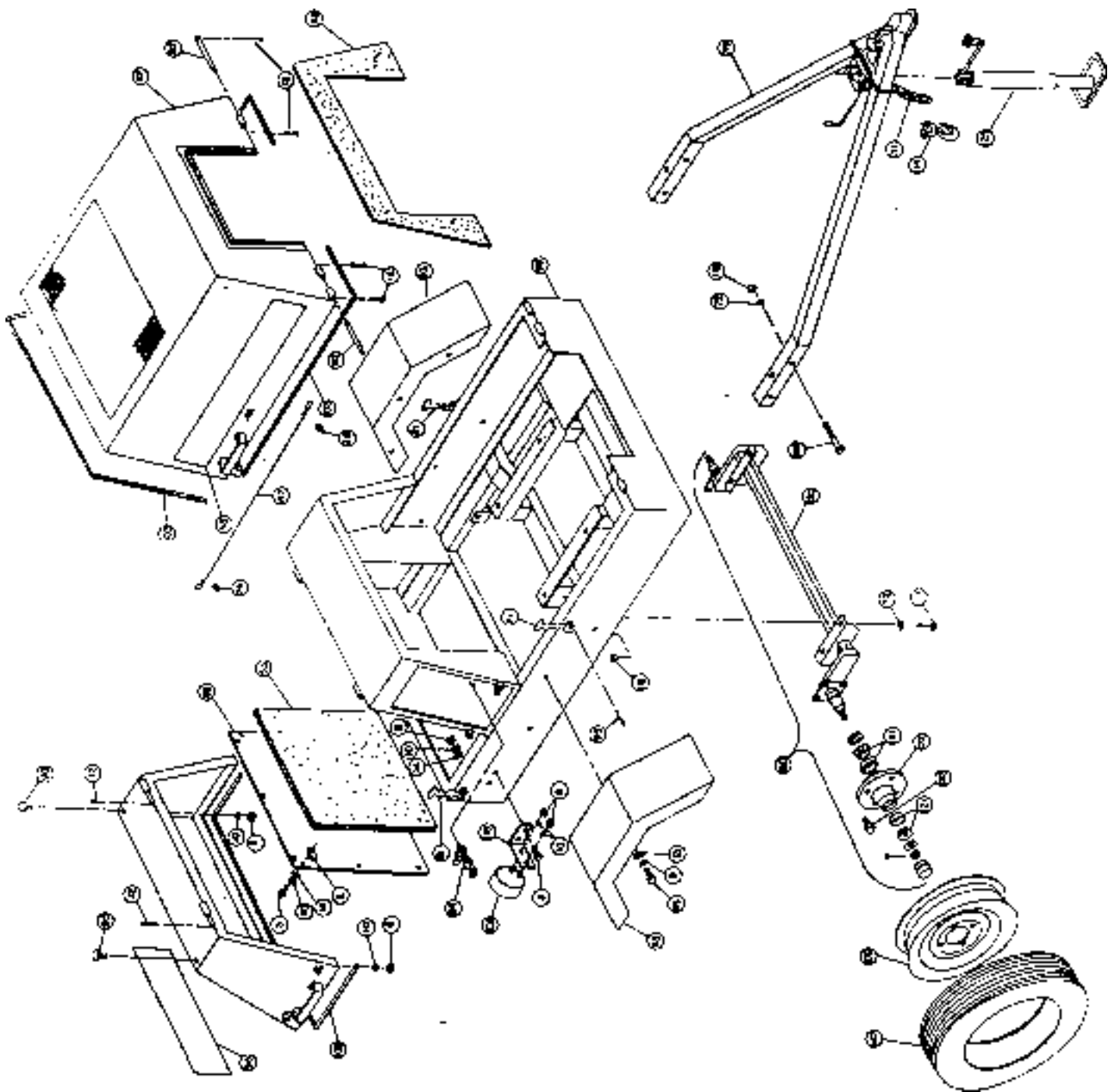

# WACHS HTM 5D POWER UNIT

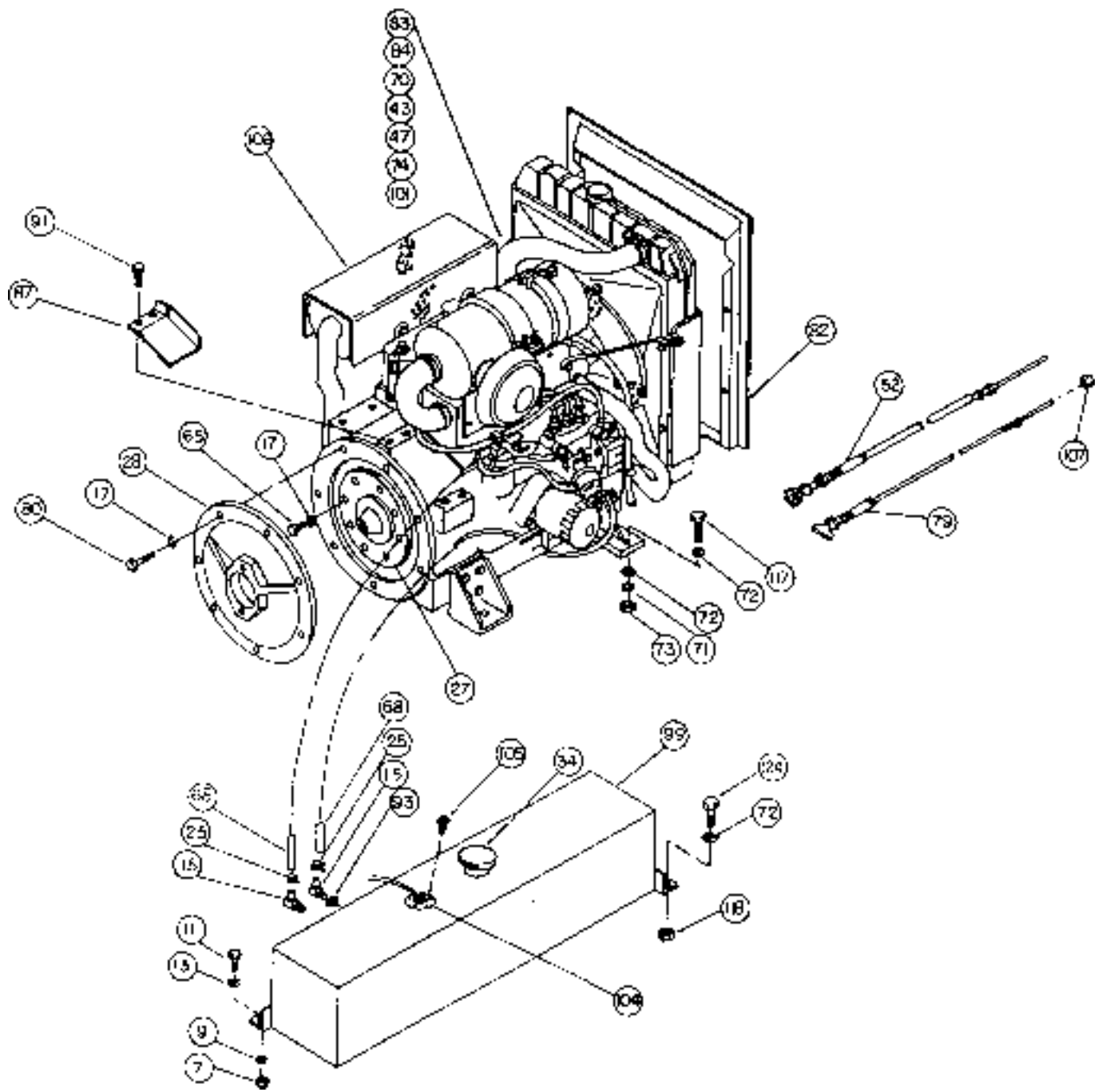

# WACHS HTM 5D POWER UNIT

## SECTION VIII

## ORDERING INFORMATION

To place an order or to get more detailed information on any E.H. Wachs products, call us at:  
1-800-323-8185.

### ORDERING REPLACEMENT PARTS

Please use parts list provided in manual. Have part description and part number of required replacement part or parts to help expedite order and insure proper parts are being ordered.

### REPAIR INFORMATION

Please call E.H. Wachs Company prior to returning any equipment for repair. We will advise you of shipping and handling. Please enclose with equipment to be repaired your name, address, phone number and a brief description of problem or work to be done or estimated.

All repair work done at our plant will be estimated and the customer advised of cost and time required to complete repair.

### WARRANTY INFORMATION

Enclosed with the manual is a warranty card. Please fill out the registration card and return to E.H. Wachs. Retain the owners registration record and warranty card for your information.

### RETURN GOODS ADDRESS

E.H. Wachs Company  
100 Shepard Street  
Wheeling, Illinois 60090

#### Call or Write:

E.H. Wachs Company  
P.O. Box A  
100 Shepard Street  
Wheeling, Illinois 60090  
847-537-8800

FAX: 847-520-1147 • 847-520-1168

Toll-Free: 1-800-323-8185

	<b>HYDRAULIC TOOL</b>
	<b>POWER UNITS</b>
Model <b>HTM-5D</b> Ser.No.	<input type="text"/> <input type="text"/> <input type="text"/> <input type="text"/> <input type="text"/> <input type="text"/> <input type="text"/> <input type="text"/>
E.H. WACHS COMPANIES 100 Shepard St. Wheeling Il. 60090	