

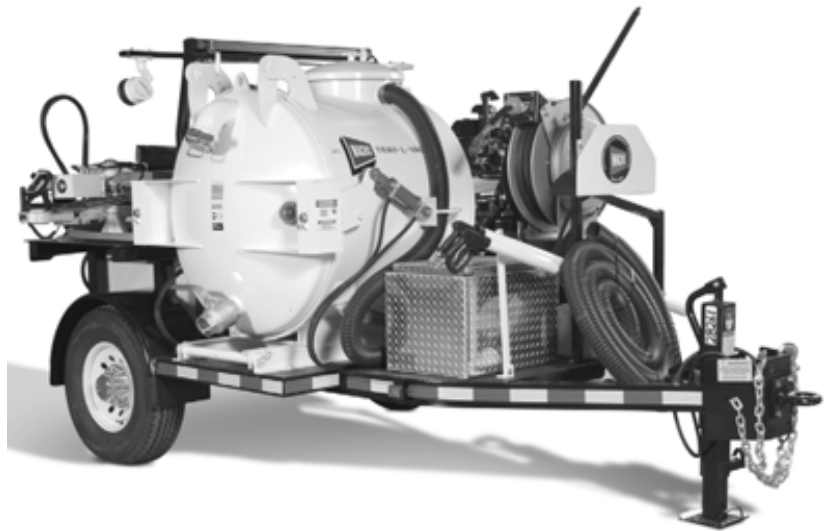

E.H. Wachs
600 Knightsbridge Parkway
Lincolnshire, IL 60069
www.ehwachs.com

VMT-1 Valve Maintenance Trailer

User's Manual



E.H. Wachs Part No. 77-MAN-21
Rev. 1-0809, August 2009

Revision History:

Original	July 2008
Rev 1	August 2009

Copyright © 2009 E.H. Wachs. All rights reserved.
This manual may not be reproduced in whole or in part
without the written consent of E.H. Wachs.

This page intentionally left blank.

Table of Contents

Chapter 1: About This Manual	1
Purpose of This Manual	1
How to Use The Manual	2
Symbols and Warnings	2
Manual Updates and Revision Tracking	3
Component Manuals	4
Chapter 2: Safety	5
Operator Safety	5
Safety Symbols	6
Protective Equipment Requirements	7
Safety Labels	7
Chapter 3: Introduction to the Equipment	13
Standard VMT-1 Equipment	13
Trailer	13
Engine	18
Gas Engine	18
Diesel Engine	19
Vacuum System	20
Pressure Washer	22
Upgraded VMT-1	22
Hydraulic System	23
Light Bar	24
Hydraulic Hose Reel	25
Locking Job Box	25
Spare Tire Kit	26
Optional Equipment	27
Water Heater	27
TM-7 Automated Valve Exerciser	28
ERV-750 Extended Reach Valve Exerciser	29
Chapter 4: Assembly, Disassembly, and Storage	31
First-Time Use	32
Storage Procedures	33
Standard Equipment	33
Optional Equipment	33
Taking the Equipment out of Storage	34
Standard Equipment	34
Optional Equipment	34
Cycling Antifreeze out of the System	35

Cold Weather Storage	37
Pressure Washer	37
Trailer Without Water Heater	37
Trailer With Water Heater	40
Chapter 5: Operating Instructions	45
Trailer Features	45
Towing the Trailer	45
Storing Vacuum Wands and Other Accessories	46
Spare Tire Option	47
Locking Job Box Option	48
Starting and Running the Engine	49
Gas Engine	50
Diesel Engine	51
Vacuum System Operation	53
Selecting a Vacuum Wand	53
Setup and Operation	53
Emptying the Tank	59
Draining Liquid	59
Dumping Solids	62
Unclogging the Vacuum	66
Pressure Washer Operation	68
Filling the Water Tank	68
Filling the Antifreeze (Primer) Tank	69
Using the Pressure Washer	70
Priming the Washer Pump	73
Prime Using the VMT-1 Pump Draw	73
Prime Using a Pressurized Water Source	76
Light Bar Operation	80
Hydraulic Hose Reel Operation	81
Water Heater Operation	84
Starting and Running the Water Heater	84
Spraying Hot Water	87
Heating the Tank Water	88
Circulating Hot Water	89
Valve Exerciser	90
Operating the TM-7	90
Operating the ERV-750	94
Trailer Systems without a TM-7	94
Trailer Systems With a TM-7	95

Chapter 6: Routine Maintenance	97
Engine Maintenance	97
Daily Maintenance	98
Cleaning the Vacuum Filter	98
Lubricating the Blower	101
Weekly Maintenance	104
Monthly Maintenance	106
Oil Change Schedule	107
Engine	107
Sprayer Pump	107
Blower	109
Cleaning the Water Strainer	110
Chapter 7: Service and Repair	111
Changing a Tire	111
Replacing Tank Shut-Off Seal	113
Replacing Control Panel Switches	114
Replacing Fuses	119
Servicing the Drive Belts	120
Vacuum Blower Belts	120
Sprayer Pump Belts	123
Adjusting the Tank Latches	126
Replacing the Battery	129
Jump-Starting the Engine	130
Replacing Light Bar Bulbs	132
Light Bar Flashers	132
Work Lights	133
Chapter 8: Parts Lists and Drawings	135
Chapter 9: Accessories and Parts	149
Options	149
Accessories	150
Replacement Parts	151
Chapter 10: Ordering Information	155
Ordering Replacement Parts	155
Repair Information	156
Warranty Information	156
Return Goods Address	156

This page intentionally left blank.

Chapter 1

About This Manual

PURPOSE OF THIS MANUAL

This manual explains how to operate and maintain the VMT-1 valve maintenance trailer. It includes instructions for set-up, operation, and maintenance, in addition to parts lists, diagrams, and service information to be used when ordering replacement parts and performing user-serviceable repairs.

Some of the equipment options available with the VMT-1 have separate manuals. These are noted in the equipment description sections of Chapter 3. Read and understand the appropriate optional equipment manuals before operating the equipment.

Before operating the VMT-1, read through this manual and become familiar with all instructions. At a minimum, read and understand the following chapters:

- Chapter 1, About This Manual
- Chapter 2, Safety
- Chapter 3, Introduction to the Equipment
- Chapter 5, Operating Instructions
- Chapter 9, Accessories

Prior to performing service or repairs, read and understand the following chapters:

- Chapter 1, About This Manual
- Chapter 4, Assembly and Disassembly
- Chapter 6, Routine Maintenance
- Chapter 7, Service and Repair.
- Chapter 8, Parts Lists and Drawings.

In This Chapter

PURPOSE OF THIS MANUAL
HOW TO USE THE MANUAL
SYMBOLS AND WARNINGS
MANUAL UPDATES AND
REVISION TRACKING
COMPONENT MANUALS

Throughout this manual, refer to this column for warnings, cautions, and notices with supplementary information.

HOW TO USE THE MANUAL

This manual is organized so that information can be found quickly and easily. Each chapter describes a specific topic on using or maintaining the equipment.

Each page is designed with two columns. The large column on the inside of the page contains instructions and illustrations. Use these instructions to operate and maintain the equipment.

The narrower column on the outside of the page contains additional information such as warnings, special notes, and definitions. Refer to the narrow column for safety notes and other information.

SYMBOLS AND WARNINGS

The following symbols are used throughout this manual to indicate special notes and warnings. They appear next to the section that they refer to, in the outside column of the page. It is important to understand what each symbol means, and follow all instructions for cautions and warnings.



WARNING

A WARNING alert with the safety alert symbol indicates a potentially hazardous situation that **could** result in **serious injury or death**.



This is the **safety alert symbol** and is used to notify the user of **potential personal injury hazards**. Obey all safety messages that follow this symbol to avoid possible injury or death.



CAUTION

A CAUTION alert with the safety alert symbol indicates a potentially hazardous situation that **could** result in **minor or moderate injury**.

This is the **equipment damage alert symbol** and is used to notify the user of **potential equipment damage situations**. Obey all messages that follow this symbol to avoid damaging the equipment or work piece on which it is operating.



CAUTION

A CAUTION alert with the damage alert symbol indicates a situation that **will** result in **damage to the equipment**.



IMPORTANT

An IMPORTANT alert with the damage alert symbol indicates a situation that **may** result in **damage to the equipment**.

NOTE

This symbol indicates a user note. **Notes** provide additional information to supplement the instructions, or tips for easier operation.



NOTE

A NOTE provides supplementary information or operating tips.

MANUAL UPDATES AND REVISION TRACKING

Occasionally, manuals will be updated with improved operation or maintenance procedures, or with corrections if necessary. Revised manuals will include an updated revision history on the title page.

If factory service or upgrades are performed on the equipment and that service changes any technical data or operation and maintenance procedures on the equipment, a revised manual will be returned with the equipment.

Current versions of E.H. Wachs Company manuals are also available in PDF format. You can request an electronic copy of this manual by emailing customer service at sales@wachSCO.com.

COMPONENT MANUALS

The following manufacturers' manuals are supplied for components of the VMT-1 system:

- Kohler engine *Owner's Manual* (for gas engine)
- Kohler engine *Service Manual* (for gas engine)
- Briggs & Stratton *Vanguard Diesel Operating & Maintenance Instructions* (for diesel engine)
- Water Cannon *Hot Water Series Pressure Washer Operator's Instruction Manual*
- Dexter *Electric Brakes* manual
- Dexter *Hubs/Drums/Bearings* manual
- Monarch *M Series DC Hydraulic Power Units Information and Troubleshooting Guide*

Chapter 2

Safety

The E.H. Wachs Company takes great pride in designing and manufacturing safe, high-quality products. We make user safety a top priority in the design of all our products.

Read this chapter carefully before operating the VMT-1. It contains important safety instructions and recommendations.

OPERATOR SAFETY

Follow these guidelines for safe operation of the equipment.

- **READ THE OPERATING MANUAL.** Make sure that you understand all setup and operating instructions before you begin.
- **INSPECT MACHINE AND ACCESSORIES.** Before starting the machine, look for loose bolts or nuts, leaking lubricant, rusted components, and any other physical conditions that may affect operation. Properly maintaining the machine can greatly decrease the chances for injury.
- **ALWAYS READ PLACARDS AND LABELS.** Make sure all placards, labels, and stickers are clearly legible and in good condition. Replacement labels can be purchased from E.H. Wachs Company.
- **KEEP CLEAR OF MOVING PARTS.** Keep hands, arms, and fingers clear of all rotating or moving parts.

In This Chapter

OPERATOR SAFETY

SAFETY LABELS



Look for this symbol throughout the manual. It indicates a personal injury hazard.

Always turn machine off before doing any adjustments or service.

- **SECURE LOOSE CLOTHING AND JEWELRY.** Secure or remove loose-fitting clothing and jewelry, and securely bind long hair to prevent them from getting caught in moving parts of the machine.
- **KEEP WORK AREA CLEAR.** Keep all clutter and nonessential materials out of the work area. Only personnel directly involved with the work being performed should have access to the area.

Safety Symbols



This icon is displayed with any safety alert that indicates a personal injury hazard.

WARNING

This safety alert indicates a potentially hazardous situation that, if not avoided, **could** result in **death or serious injury**.

CAUTION

This safety alert, with the personal injury hazard symbol, indicates a potentially hazardous situation that, if not avoided, **could** result in **minor or moderate injury**.

Protective Equipment Requirements

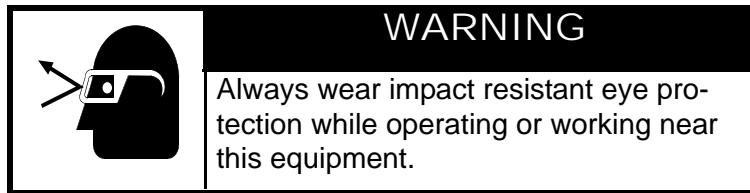

For additional information on eye and face protection, refer to Federal OSHA regulations, 29 Code of Federal Regulations, Section 1910.133., Eye and Face Protection and American National Standards Institute, ANSI Z87.1, Occupational and Educational Eye and Face Protection. Z87.1 is available from the American National Standards Institute, Inc., 1430 Broadway, New York, NY 10018.

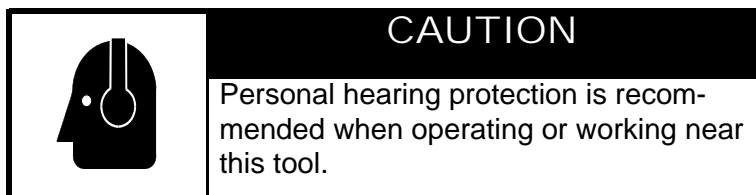

Hearing protectors are required in high noise areas, i.e. 85 dBA or greater. Noise level can be increased by the operation of other tools and equipment in the area, reflective surfaces, process noises, and resonant structures. For additional information on hearing protection, refer to Federal OSHA regulations, 29 Code of Federal Regulations, Section 1910.95, Occupational Noise Exposure and ANSI S12.6 Hearing Protectors.

SAFETY LABELS

The following safety labels are included on the VMT-1 trailer system. (Some labels are associated with optional equipment.) Ensure that all labels are in good condition and legible. Replace any damaged or missing labels. To order replacements, refer to the part numbers in this section and see the ordering instructions in Chapter 10.



Figure 2-1. The eye and ear protection label is on the vacuum filter housing, below the control panel, and on the door of the spoils tank (3 locations). Wear protective gear when operating the vacuum system. (Part no. 77-160-05.)

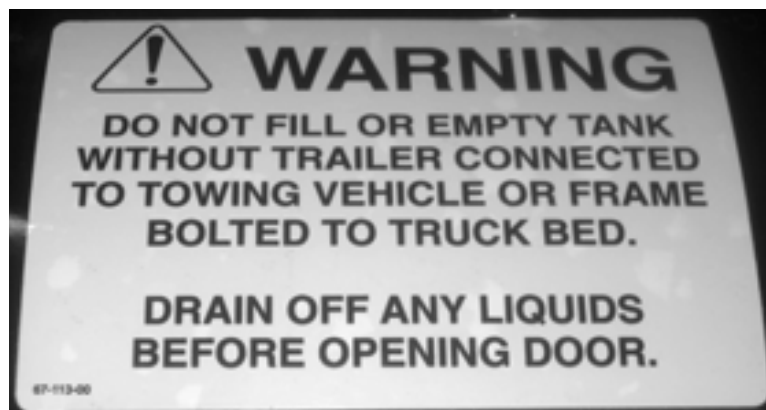

Figure 2-2. This warning label is on the vacuum filter housing. Keep the trailer connected to the vehicle when operating the vacuum system. Drain liquids through the drain valve before opening the door to dump the tank. (Part no. 67-113-00.)

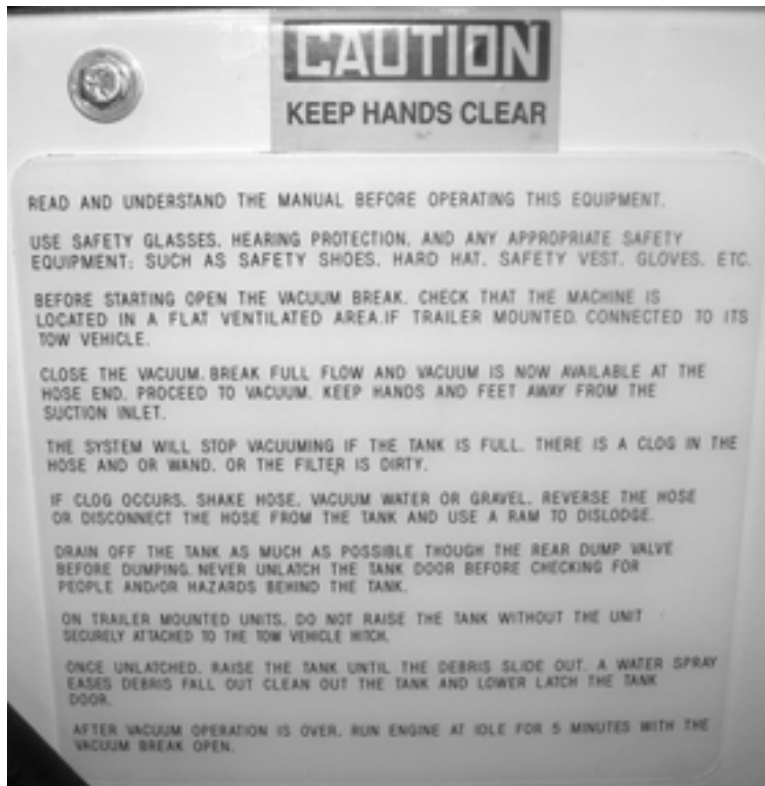

Figure 2-3. The safety and instruction label is on the drive belt cover to the left of the gas engine. It lists operating and general safety guidelines. (Part no. 77-094-00.)



Figure 2-4. This caution label is on the belt cover toward the rear of the trailer. Keep hands away from the belt drive area while any equipment is operating or the gas engine is running. (Part no. 77-160-11.)



Figure 2-5. These danger labels are on both sides of the spoils tank at the door latches. Keep clear of the door when opening or closing it, or moving the tank. (Part no. 77-160-10 [above] and 77-160-25 [below].)



Figure 2-6. This caution label is on the head of the optional ERV-750 valve exerciser. Read all manuals provided with the trailer and optional equipment before operating the equipment. (Part no. 90-900-01.)

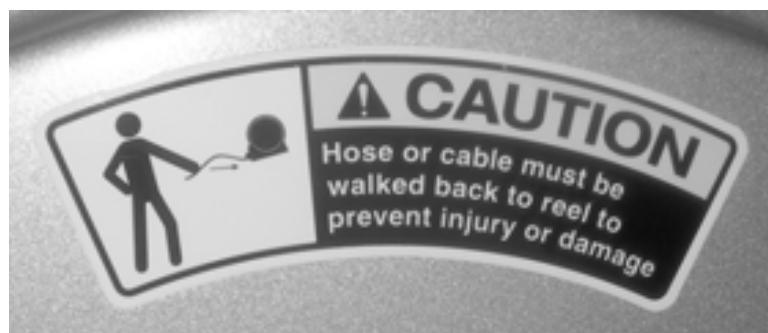

Figure 2-7. This label is on the hydraulic hose reel. When retracting the hose, walk it back to the reel. Do not let the hose snap back into the reel. (Contact the manufacturer, Cox Reels, for replacement labels.)



Figure 2-8. This caution label is on the hydraulic hose reel. Do not disassemble the spring from the reel. (Contact the manufacturer, Cox Reels, for replacement label.)



Figure 2-9. This warning label is on the trailer fender. Prior to each use of the trailer, check tire condition and lug nut tightness. (Part no. 77-160-15.)

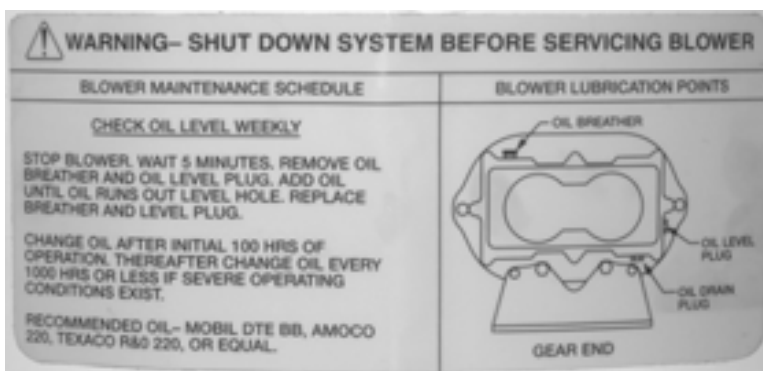

Figure 2-10. This warning label is on the blower housing. Shut down the system when servicing the blower. (Part no. 67-111-00.)

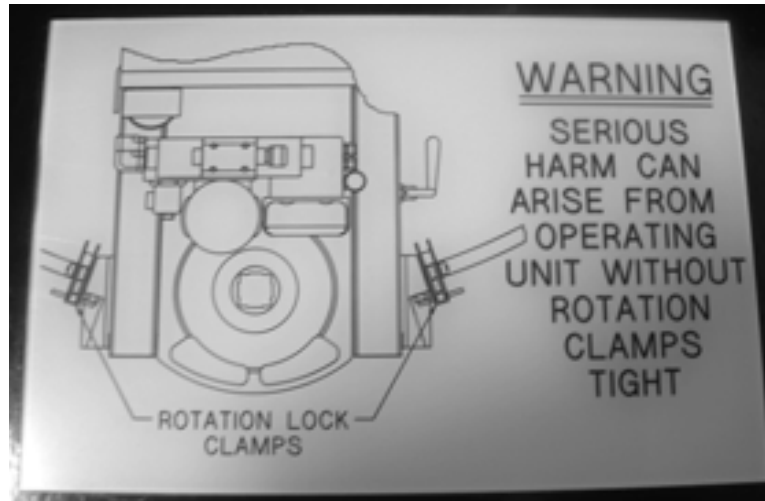

Figure 2-11. This warning label is on the trailer deck at the storage location for the TM-7 valve exerciser. Ensure that the rotation clamps on the TM-7 are tightened when using the valve exerciser or moving the trailer. (Part no. 67-112-00.)

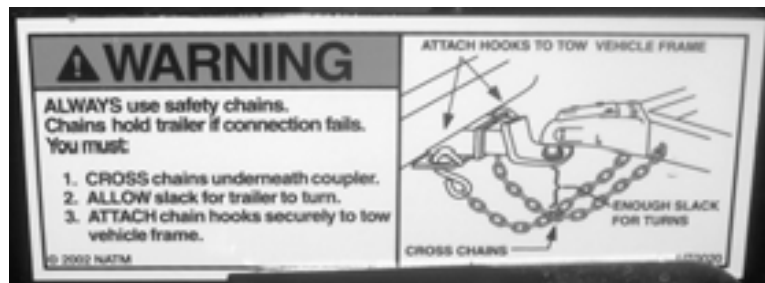

Figure 2-12. The safety chain warning label is on the tongue of the trailer. (Part no. 77-160-20.)

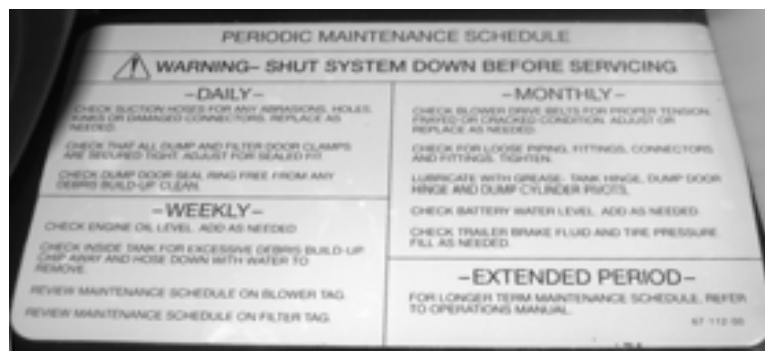

Figure 2-13. This label is on the trailer deck next to the engine. Shut the system down before performing service. (Part no. 67-112-00.)

Chapter 3

Introduction to the Equipment

STANDARD VMT-1 EQUIPMENT

The following standard equipment is provided with the basic 77-000-21 (gas engine) or 77-000-23 (diesel engine) configuration of the VMT-1:

- trailer
- gas or diesel engine
- vacuum system
- pressure washer

These components are described in the following sections.

Trailer

The VMT-1 is a single-axle trailer designed for a full range of utility service equipment. It features all-steel construction with a four-inch I-beam frame and steel deck.

The VMT-1 has a Gross Vehicle Weight Rating, or GVWR, of 7,000 lbs. GVWR is the maximum vehicle weight (including all contents carried in or on the vehicle) set by the manufacturer to ensure the safe operation of the vehicle. GVWR does not reflect the maximum weight obtainable when all cargo areas, storage bays, and containers are filled to capacity. This is true for any vehicle. By setting the GVWR of the VMT-1 at 7,000 lbs, E.H. Wachs provides a practical balance between intended use and safe operation. The operator must be aware of the vehicle's GVWR and adjust payloads accordingly to ensure that the GVWR limit is not exceeded.

In This Chapter

STANDARD VMT-1 EQUIPMENT

UPGRADED VMT-1

OPTIONAL EQUIPMENT



NOTE

Weight specifications are for an upgraded, gasoline powered VMT-1 (77-000-22) plus the optional TM-7 Automated Valve Exerciser and ERV-750 Automated Valve Exerciser.

Following are the VMT-1 trailer specifications:

Length	15 ft
Width	7-1/2 ft
Height	7 ft
Gross Vehicle Weight Rating (GVWR)	7,000 lbs
Curb Weight (empty)	5,300 lbs
Tongue weight (empty)	850 lbs
Trailer axle weight (empty)	4,450 lbs
Tires	15 inch minimum, rated for max. GVWR
Brakes	Electric, rated for max. GVWR
Hitch options	Pintle assembly (77-404-01); 2-5/16" ball assembly (77-404-02)
Wiring and lighting	DOT and MTO com- pliant

Refer to the following table for how payload changes affect the axle and tongue loading of the trailer. These approximate changes affect any configuration of the VMT-1 and are intended only to assist in maintaining proper trailer loading. Any equipment or cargo added to or taken off of the trailer will affect axle and tongue loadings differently and is beyond the control of E.H. Wachs.

TRAILER WEIGHT CHANGES E.H. WACHS VMT-1

ACTION	CHANGE IN TRAILER WEIGHT	CHANGE IN AXLE WEIGHT	CHANGE IN TONGUE WEIGHT
Add 25 gallons to freshwater tank	208 lbs	+225 lbs	-17.5 lbs
Add 50 gallons of water to spoils tank	416 lbs	+311.5 lbs	+105 lbs
Add 50 gallons of mud/gravel (110 lbs/cu. ft)	735 lbs	+550 lbs	+185 lbs

Photos on the following pages illustrate the major components of the VMT-1 trailer.

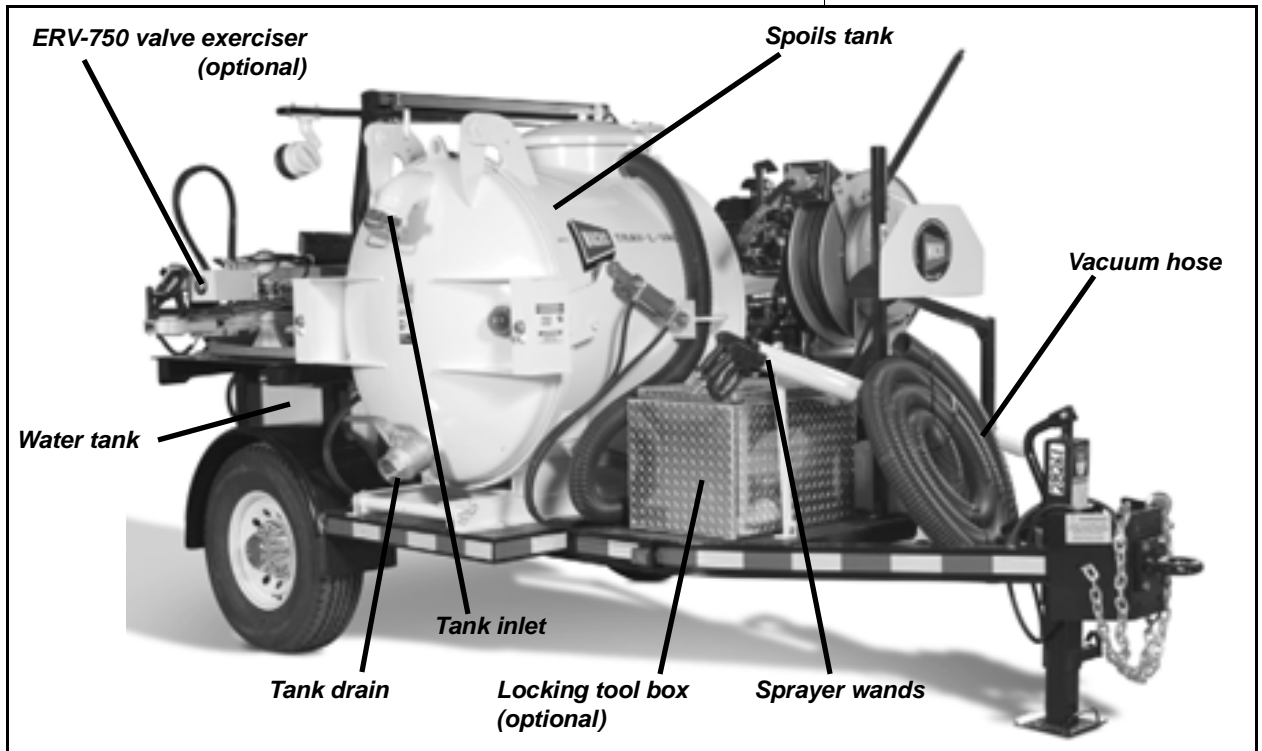

Figure 3-1. The right side of the VMT-1 trailer.

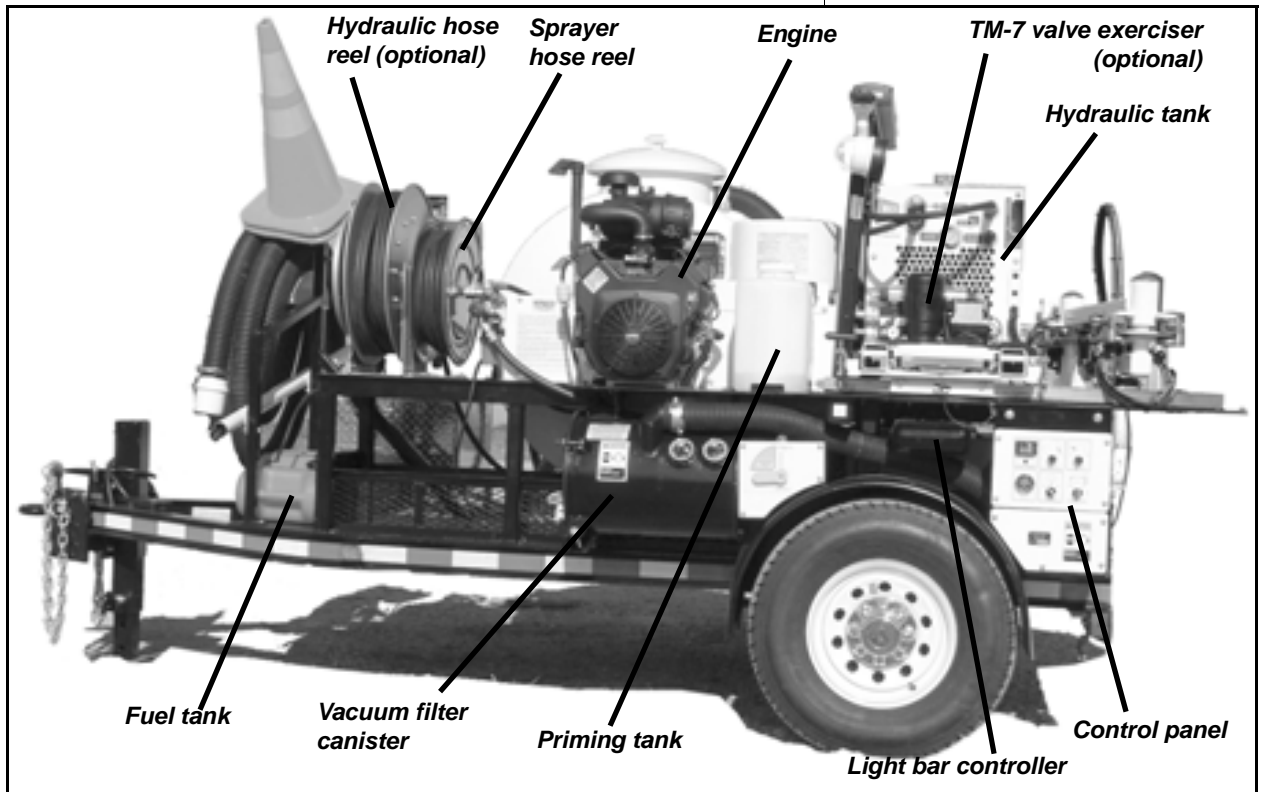

Figure 3-2. The left side of the VMT-1 trailer.

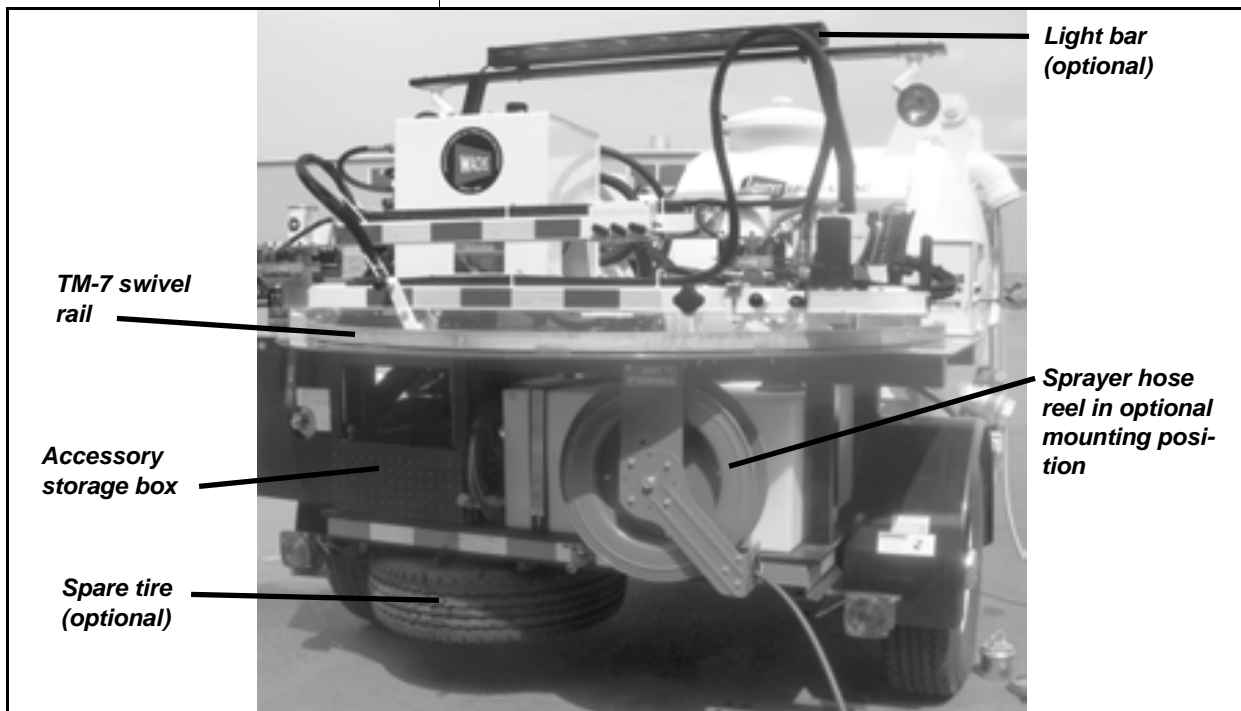

Figure 3-3. The back of the VMT-1 trailer.

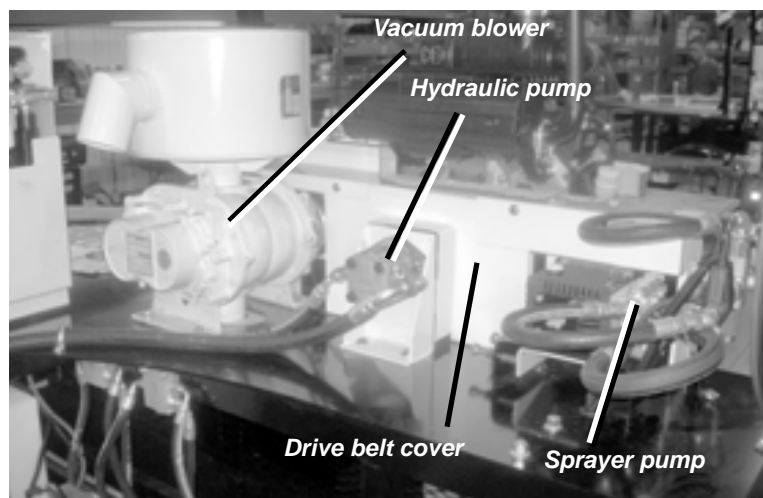

Figure 3-4. The vacuum blower, hydraulic pump, and sprayer pump as seen from behind the engine with the spoils tank tipped forward.

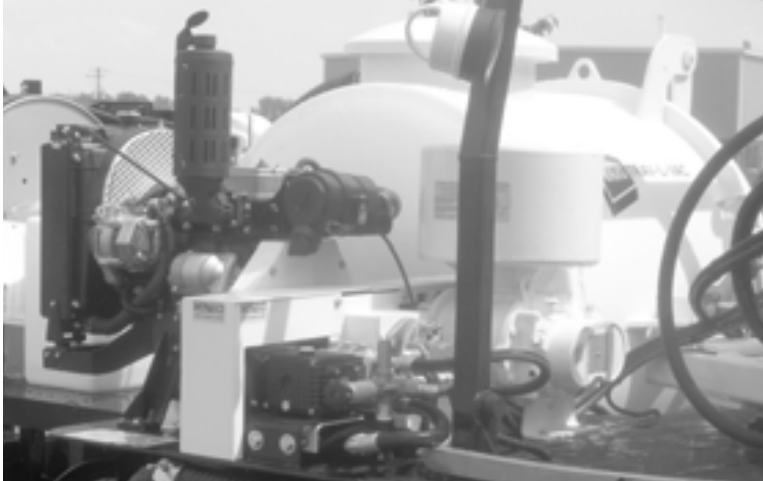

Figure 3-5. An alternate configuration is available with a diesel engine and traverse-mounted drive enclosure for the pumps.

Engine

The standard VMT-1 engine is a Kohler gas model. A Briggs & Stratton diesel is available as an option.

Gas Engine

The trailer's equipment is powered by a 27 HP Kohler Command Pro CH740 gasoline engine. This overhead cam, horizontal crankshaft engine has an electric starter. The engine operates the vacuum system, pressure washer, and optional hydraulic pump.

The engine operates on 87 octane unleaded gasoline or on 10% ethanol/90% gasoline "gasohol" blend. Use a winter blend fuel when running the engine in cold weather.

The Kohler engine is provided with an *Owner's Manual* and a *Service Manual*. Refer to the Kohler manuals for operating guidelines, maintenance, and service of the engine.



Figure 3-6. The gasoline engine, shown in the center, powers all of the equipment provided with the VMT-1.

Diesel Engine

An optional diesel engine is available. The Briggs & Stratton Vanguard model 582447 is a three-cylinder engine providing 26.5 horsepower. It features an electric starter and is water cooled.

The engine operates on minimum 40 cetane diesel fuel. Do not use kerosene or gasoline in the diesel engine.

The diesel engine is provided with an *Operator's Manual*. Refer to the Briggs & Stratton manual for operating guidelines, maintenance, and service of the engine.



Keyswitch and throttle

Figure 3-7. The diesel engine is shown. The engine keyswitch and throttle are located remotely next to the trailer control panel.

Vacuum System

The utility vacuum system includes a 500 CFM, 11" Hg positive displacement blower, tach/hourmeter, silencer, and washable filter. A suction hose (3" x 20 ft) and a standard wand (3" x 6 ft) are provided. The vacuum includes a 200 gallon holding tank with a hydraulic dump door operated at the control panel.



Figure 3-8. The tank dumping mechanism moves the tank to the side of the trailer, opens the door latch, and tips the tank for dumping.



Figure 3-9. The vacuum system filter canister shown with the clean-out door open.

A 3" flex hose is provided with the vacuum system. The hose is coiled and stored on the front of the trailer, as shown in Figure 3-10.



Figure 3-10. The vacuum hose is rolled up and stored on the front of the trailer.

Various sized vacuum wands are available for the vacuum system (see Figure 3-12). All wands have a standard connector for the 3" suction hose. Wand diameters are as follows:

- 7/8"
- 1"
- 1 1/4"
- 1 1/2"
- 2"
- 2 1/4"
- 2 1/2"
- 3"

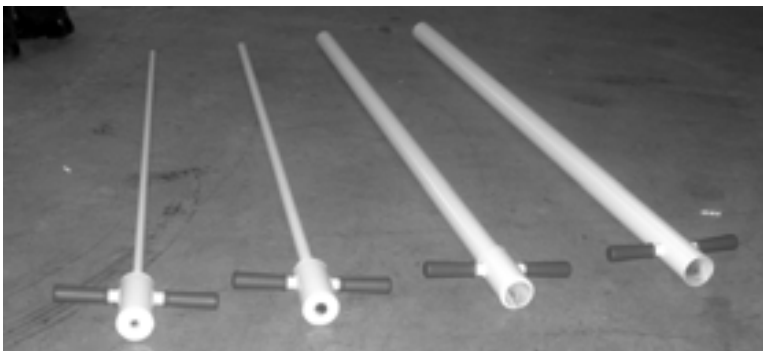

Figure 3-11. Various sized vacuum wands are available. All wands are fitted to the 3" vacuum hose.

Pressure Washer

The clutch-driven pressure washer outputs 2.5 gpm @ 3000 psi, includes a 5 gallon priming tank and 66 gallon water tank, a sprayer wand and 50 ft hose on a spring-rewind hose reel.

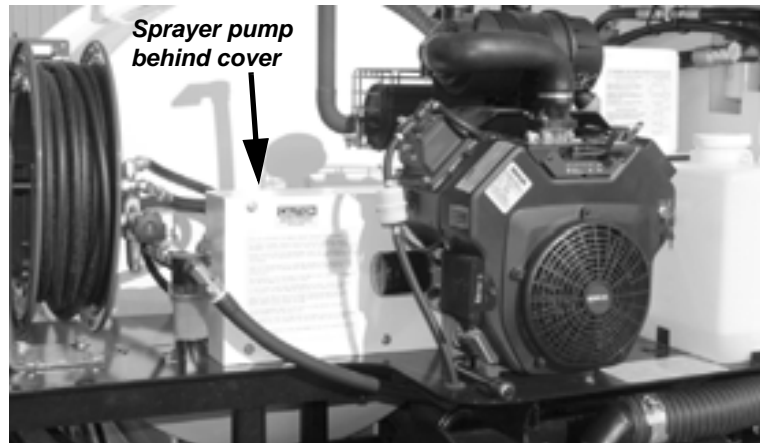

Figure 3-12. The sprayer pump is behind the cover to the side of the engine, with the sprayer hose reel to the left.

Two sprayer wands are available with the pressure washer. A short wand is designed for cleaning the trailer and equipment after use; a longer wand is used to clear dirt and debris in the work area.

UPGRADED VMT-1

The following additional equipment is included in the upgraded 77-000-22 (gas engine) or 77-000-24 (diesel engine) VMT-1 configuration:

- hydraulic pump
- light bar
- hydraulic hose reel
- locking job box
- spare tire kit

The following sections describe these components. Any combination of these equipment items can be added to the basic 77-000-21 system.

Hydraulic System

The hydraulic pump provides power to a valve exerciser or to auxiliary equipment (HTMA Class II circuit). It has a maximum output of 8 gpm at 1800 psi. The 10 gallon hydraulic oil reservoir has a sight gauge for oil level and temperature. The system includes an auxiliary power port, relief valve, and an oil cooler with an electric fan.

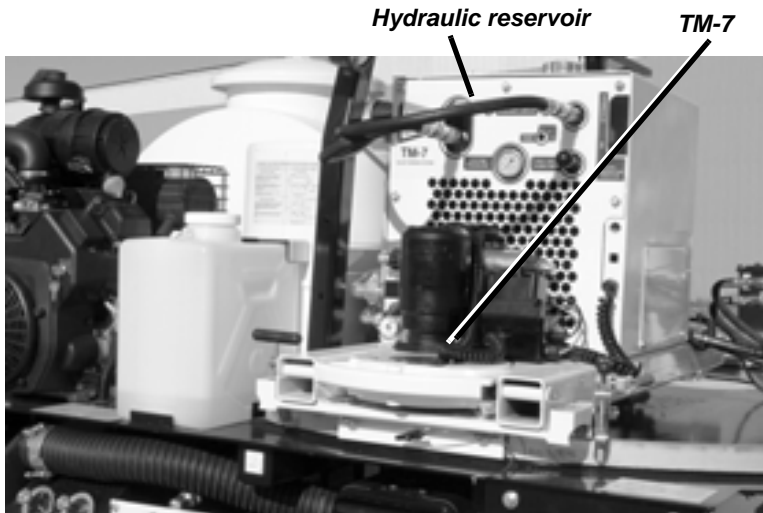

Figure 3-13. The hydraulic system reservoir. The optional TM-7 valve exerciser is attached in front of the reservoir.

Light Bar

An overhead light bar with work lights and a programmed arrow board is available. The light bar includes an electronic control panel in a watertight enclosure.



Figure 3-14. The light bar included with the upgraded VMT-1.

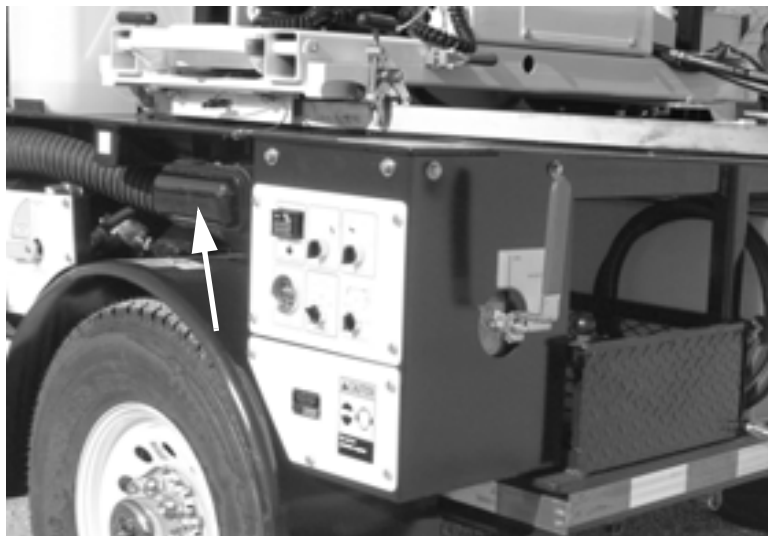

Figure 3-15. The light bar controller is housed in a water-tight enclosure above the left fender.

Hydraulic Hose Reel

The hose reel supplies 45 ft of 1/2" hydraulic hose (rated 2000 psi) for operating auxiliary equipment. It includes hose whips and connectors to connect to the auxiliary tools.

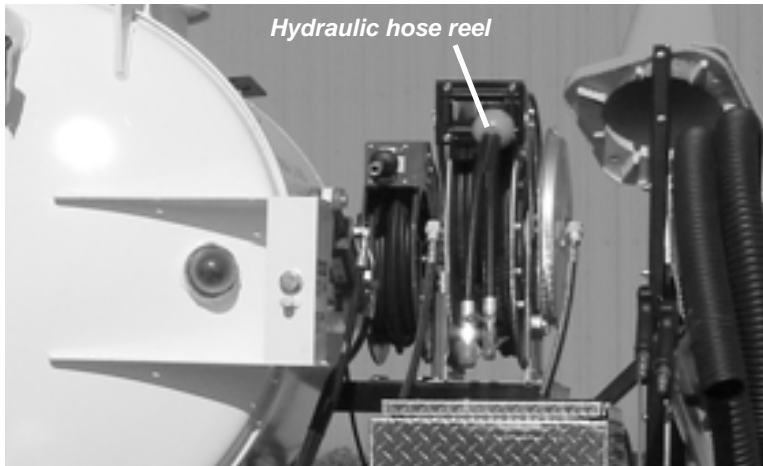

Figure 3-16. The auxiliary hydraulic hose reel is mounted on the front of the trailer.

Locking Job Box

A job box for holding valve keys and other tools is available. The diamond-plate aluminum box is bolted to the trailer frame.

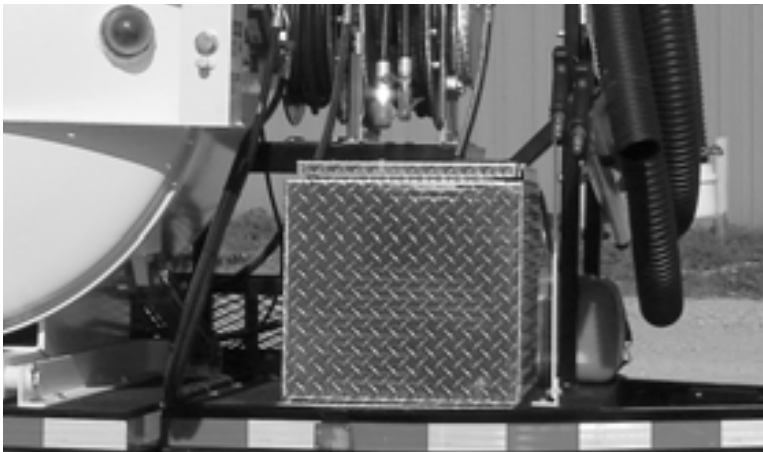

Figure 3-17. The optional locking job box is mounted on the front of the trailer.

Spare Tire Kit

A spare tire kit with matching tire and rim for the trailer is available. It includes mounting hardware to secure the tire to the underside of the trailer.



Figure 3-18. The spare tire is mounted beneath the back of the trailer on a cable mechanism. To remove the tire, turn the cable drive nut with a 3/4" wrench or socket until the tire is on the ground.

OPTIONAL EQUIPMENT

The following equipment items are options available with the VMT-1. The trailer can be equipped with any combination of these options.

Water Heater

The water heater is a self-contained unit with a diesel burner and heat exchanger for heating the water from the trailer's water storage tank. Hot water may be sprayed directly from the heater, or recirculated to the tank or through the entire sprayer system.

The manufacturer's manual for the water heater is included with the VMT-1. Read the manual before operating the heater.

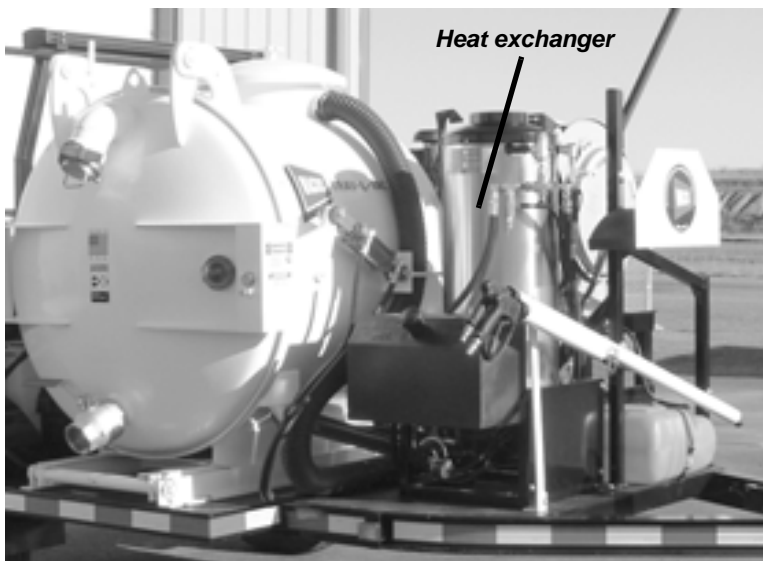

Figure 3-19. The VMT-1 trailer with the optional water heater.

TM-7 Automated Valve Exerciser

The TM-7 is a heavy-duty automated valve exerciser providing up to 1,500 lb-ft of torque. The power head is mounted on a rigid frame that slides out over the valve location and slides back onto the trailer for storage.



Figure 3-20. The TM-7 is shown with its frame extended.

The TM-7 includes a water- and shock-resistant handheld control unit for operating the machine and collecting valve exercising data. The controller can operate the TM-7 in manual mode or in an exercising mode that automatically controls torque and direction to exercise valves safely and completely.

The hydraulic pump option must be installed on the VMT-1 to operate the TM-7. Purchase the TM-7 installation kit (17-420-00) when retrofitting an existing VMT-1 trailer with the TM-7.



NOTE

When both the TM-7 and ERV-750 are installed, the TM-7 can only be swiveled 90° from the left side to the back of the trailer.

The TM-7 is installed on a 180° swivel rail. This allows the TM-7 to be positioned anywhere from the left side to the right side of the trailer.

The TM-7 is supplied with a separate manual for operating instructions and parts/service information.

ERV-750 Extended Reach Valve Exerciser

The ERV-750 is an extended-reach hydraulic valve exerciser mounted on a pivoting, telescoping arm. It can reach valves up to 11 ft from the curb side of the trailer, and provides up to 750 lb-ft of torque.



Figure 3-21. The ERV-750 valve exerciser extends on a pivoting, telescoping arm.

The ERV-750 includes a ruggedized handheld controller/data logger for operating the machine and collecting valve exercising data. The controller is available with optional GPS capability (either standard or submeter resolution) for automated valve locating and logging.

The controller is available separately (79-410-00) if a spare or replacement is needed.

The hydraulic pump option must be installed on the VMT-1 to operate the ERV-750. Purchase the ERV-750 installation kit (79-401-00) to retrofit an existing VMT-1 trailer with the ERV-750.

The ERV-750 is supplied with a separate manual for operating instructions and parts/service information.



Chapter 4

Assembly, Disassembly, and Storage

The VMT-1 trailer comes with all major components and systems assembled and ready for use. Some assembly of accessories may be required.

This chapter describes how to set up the VMT-1 for initial operation, and how to prepare it for storage and for restoration to service.

In This Chapter

FIRST-TIME USE

STORAGE PROCEDURES

TAKING THE EQUIPMENT OUT
OF STORAGE

COLD WEATHER STORAGE

FIRST-TIME USE

Perform the following checks and procedures before using your VMT-1 trailer for the first time.

- Remove the shrinkwrap and packaging straps.
- Remove the traffic cone holder from the accessory storage box and install it on the front of the trailer, as shown in Figure 4-1.
- Fill the engine's fuel tank.
- Fill the water tank.
- Fill the priming tank.
- Prime the water pump according to the instructions in Chapter 5.



Figure 4-1. Install the traffic cone holder using the two screws as shown.

STORAGE PROCEDURES

Perform the following procedures before storing the VMT-1 trailer for an extended period of time (at least one week out of service).

Standard Equipment

- Perform the daily maintenance procedure described in Chapter 6.
- Partially release the latches on the tank door so that the door isn't compressed against the seal. Leave the latches engaged enough to keep the door from swinging open freely.
- Add fuel stabilizer to the engine fuel tank, or drain the tank.
- Drain the water tank.

Optional Equipment

- Add fuel stabilizer to the hot water kit fuel tank, or drain the tank.
- Place the optional covers on the TM-7 and ERV-750 valve exercisers.



Figure 4-2. The covers supplied with the TM-7 and ERV-750 valve exercisers.

- Lubricate the rails on the optional TM-7 valve exerciser.

TAKING THE EQUIPMENT OUT OF STORAGE

Perform the following checks and procedures when restoring the equipment to service after extended storage.

Standard Equipment

Check the following:

- Engine oil level
- Blower pump oil level
- Hydraulic oil level in the tank
- Blower and hydraulic pump belts
- All gaskets for wear or deterioration
- Tank door seal
- Condition and air pressure of the tires (including the optional spare tire)
- Trailer lights
- Vacuum system filter
- Battery, charge if necessary
- Trailer break-away system battery, charge if necessary
- Once all checks are satisfactorily completed, fill the engine fuel tank. On sealed fuel tanks, use the vented fuel tank cap when operating the VMT-1 in warm weather.



NOTE

On sealed fuel tanks, use the vented fuel tank cap when using the VMT-1 in warm weather.

Optional Equipment

When optional equipment is installed, check the following:

- Light bar - check operation
- Hot water kit - check burner and controls, fill hot water kit fuel tank.

Cycling Antifreeze out of the System

Use fresh water to cycle antifreeze out of the sprayer system when returning the unit to service or prior to starting the unit after it has been stored during freezing weather. If the optional water heater is installed, heated water may be used.

1. Fill the water tank with fresh water.
2. Move the yellow Water Supply Valve lever (in front of the left fender) to the TANKS position.

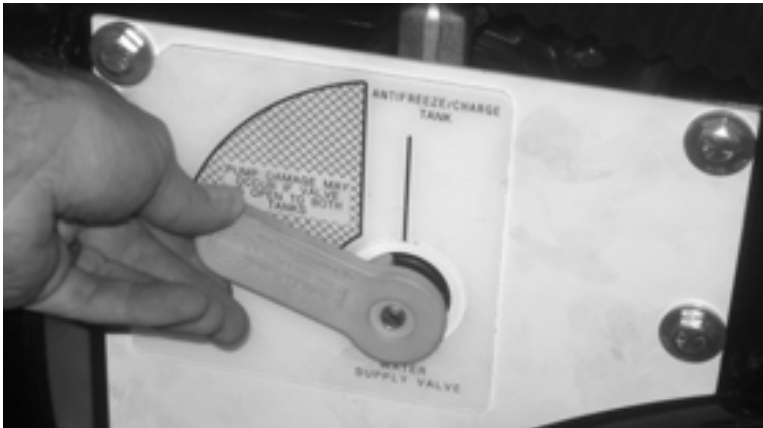

Figure 4-3. Move the Water Supply Valve to the TANKS position.

3. Start the engine and run at low to medium throttle.
4. Pull a sufficient length of hose from the sprayer hose reel to reach the priming tank; remove the tank lid and hold the hose in the tank.



NOTE

Propylene glycol (PG) anti-freeze comes in two types, motor vehicle and RV/Marine. These antifreezes are intended for completely different end uses. **Use only RV/Marine antifreeze in the sprayer system.** When cycling antifreeze out of the system, do not dump antifreeze on the ground or into storm water drains. Cycle it back into the priming tank, then remove the priming tank and dispose of the antifreeze in an approved manner.

5. At the control panel, turn the pressure washer switch to the WATER position. The antifreeze mix in the sprayer system will flow from the hose into the priming tank.



Figure 4-4. Turn the pressure washer switch to the WATER position.

6. When plain water begins to come out of the nozzle, turn off the engine.
7. Rewind the sprayer hose on the reel.

COLD WEATHER STORAGE

When storing the trailer in sub-freezing weather, even for short periods, perform the following special procedures.

Pressure Washer

Before storing the trailer in sub-freezing weather (32° F/ 0° C), cycle RV/marine antifreeze through the sprayer system using the following procedure.

Trailer Without Water Heater

1. Ensure that the priming tank is filled with an appropriate RV/marine antifreeze mix for the environmental temperature.
2. Move the yellow Water Supply Valve lever (in front of the left fender) to the ANTIFREEZE/CHARGE TANK position.



Figure 4-5. Move the Water Supply Valve to the ANTI-FREEZE/CHARGE TANK position.

3. Start the engine and run at low to medium throttle.
4. Pull a sufficient length of hose from the sprayer hose reel to reach the priming tank; remove the tank lid and hold the hose in the tank. Do not connect sprayer wand.



NOTE

Propylene glycol (PG) anti-freeze comes in two types, motor vehicle and RV/Marine. These antifreezes are intended for completely different end uses. **Use only RV/ Marine antifreeze in the sprayer system.** When cycling antifreeze out of the system, do not dump anti-freeze on the ground or into storm water drains. Cycle it back into the priming tank, then remove the priming tank and dispose of the antifreeze in an approved manner.

5. At the control panel, turn the pressure washer switch to the WATER position. The water in the sprayer system will flow from the hose into the priming tank.



Figure 4-6. Turn the pressure washer switch to the WATER position.

6. When the antifreeze mix begins to come out of the nozzle, turn off the engine.
7. Open the brass drain valve at the back of the trailer and drain all water out of the water tank.



Figure 4-7. Open the drain valve on the back of the trailer to drain the water tank.

8. Open the top of the water tank and use a wet vacuum to suction any remaining water out of the tank.
9. Pour an appropriate antifreeze mix into the water tank, to a depth of about 1 inch.

10. Move the yellow Water Supply Valve lever to the TANKS position.

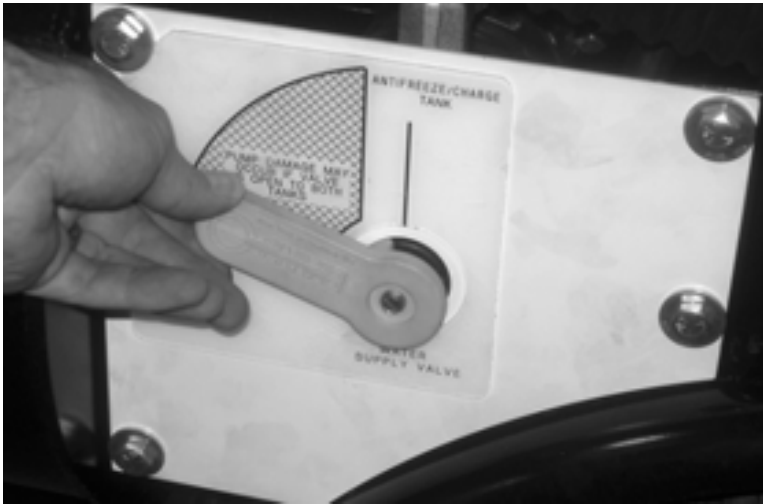

Figure 4-8. Move the Water Supply Valve to the TANKS position.

11. Repeat steps 3 through 6 above.
12. Rewind the sprayer hose on the reel.

Trailer With Water Heater

1. Ensure that the priming tank is filled with an appropriate RV/marine antifreeze mix for the environmental temperature.
2. Pull a sufficient length of hose from the pressure washer hose reel to reach the valve on the water heater. Do not connect the sprayer wand.



Figure 4-9. Pull a sufficient length of hose from the sprayer reel to reach the front of the water heater.

3. Connect the pressure washer hose to the input valve as shown in Figure 4-10.



Figure 4-10. Connect the sprayer hose to the input fitting on the water heater.

4. Turn the water heater valve handle as shown in Figure 4-11 below to direct the water flow through the sprayer system.

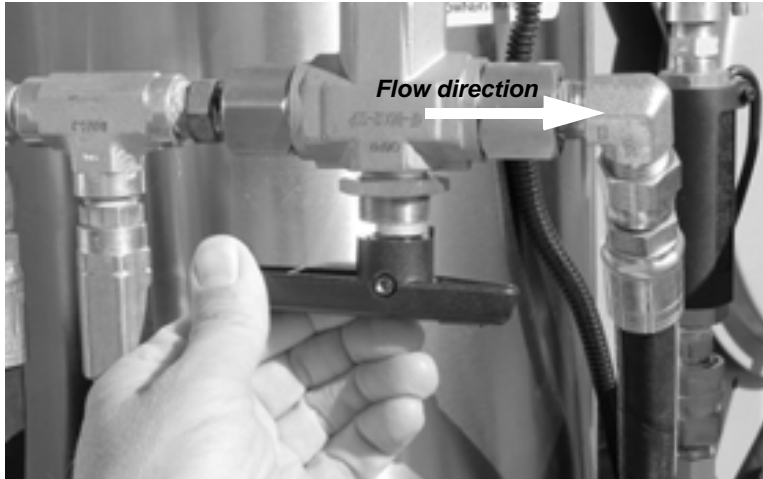

Figure 4-11. Turn the heater valve to direct the flow direction to the right. The flow is toward the shorter end of the handle.

5. Move the yellow Water Supply Valve lever (in front of the left fender) to the ANTIFREEZE/CHARGE TANK position.



Figure 4-12. Move the Water Supply Valve to the ANTIFREEZE/CHARGE TANK position.

6. Start the engine and run at low to medium throttle.

7. At the control panel, turn the pressure washer switch to the WATER position.



Figure 4-13. Turn the pressure washer switch to the WATER position.

8. Allow the system to circulate for 2-3 minutes.
9. Turn off the engine.
10. Open the brass drain valve at the back of the trailer and drain all water out of the water tank.



Figure 4-14. Open the drain valve on the back of the trailer to drain the water tank.

11. Open the top of the water tank and use a wet vacuum to suction any remaining water out of the tank

12. Pour an appropriate antifreeze mix into the water tank, to a depth of about 1 inch.
13. Move the yellow Water Supply Valve lever to the TANKS position.



Figure 4-15. Move the Water Supply Valve to the TANKS position.

14. Repeat steps 6-9 above.
15. Remove the sprayer hose from the input fitting on the water heater and rewind the hose reel.



Chapter 5

Operating Instructions

.....

This chapter provides instructions for towing the VMT-1 trailer, and for starting the engine to power the trailer's equipment.

Specific sections of the chapter provide instructions for operating the following standard and optional components of the VMT-1 system:

- vacuum system
- pressure washer
- light bar
- hydraulic hose reel
- hot water kit.

TRAILER FEATURES

Towing the Trailer

Before towing the trailer:

- Take the key out of the engine keyswitch.
- Ensure that the:
 - hitch is properly attached and the safety chains are attached to the vehicle.
 - trailer tail lights, brake lights, and turn signals are working.
 - jack stand on the trailer hitch is raised.

In This Chapter

TRAILER FEATURES

STARTING AND RUNNING THE ENGINE

VACUUM SYSTEM OPERATION

PRESSURE WASHER OPERATION

LIGHT BAR OPERATION

HYDRAULIC HOSE REEL OPERATION

WATER HEATER OPERATION

VALVE EXERCISER

- storage box door at the back of the trailer is closed and latched.
- tires are properly inflated.
- all hoses, wands, and other attachments are securely stored on the trailer.
- the optional locking job box (if installed) is closed.
- If the TM-7 is installed, remove the controller from its cradle and put it in the vehicle, ensure that the swivel rail locks are tightened down and the power head slide assembly is pushed in and the lock engaged.
- If the ERV-750 is installed, ensure that it is secured to the trailer bed with the latches, remove the controller from its cradle and put it in its storage case. Store the case in the vehicle.

Storing Vacuum Wands and Other Accessories

Use the accessory storage box beneath the trailer bed to store vacuum wands, valve keys, and other tools and accessories. Open the door beneath the back of the trailer to access the storage box.

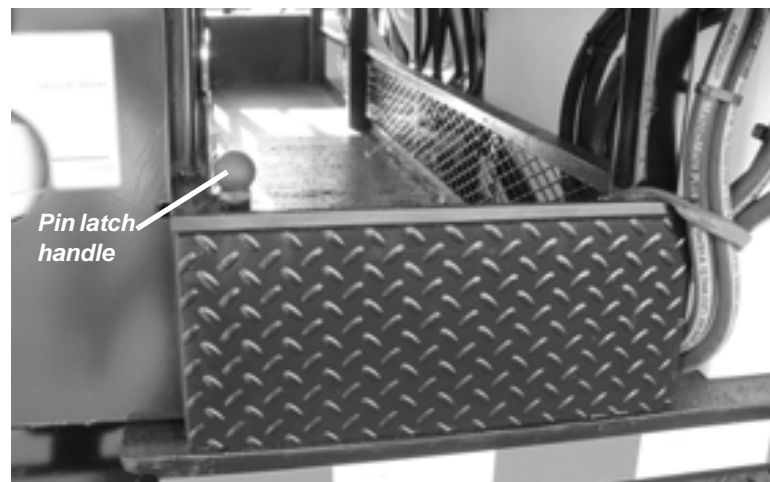

Figure 5-1. Access the storage box at the back of the trailer. Pull up the pin latch to open the door.

Spare Tire Option

The optional spare tire is secured beneath the rear of the trailer with a cable mechanism. To remove the spare tire, use a socket wrench to turn the cable release nut. The tire will be lowered to a position where it can be taken off the mounting hub.



Figure 5-2. Turn the cable release nut to lower the spare tire to remove it.

Make sure that the spare tire is securely attached before towing the trailer.

Locking Job Box Option

The optional locking job box mounts at the front of the trailer for easy access and includes a key lock for security. Unlock the box, then lift and turn the handle to open it.

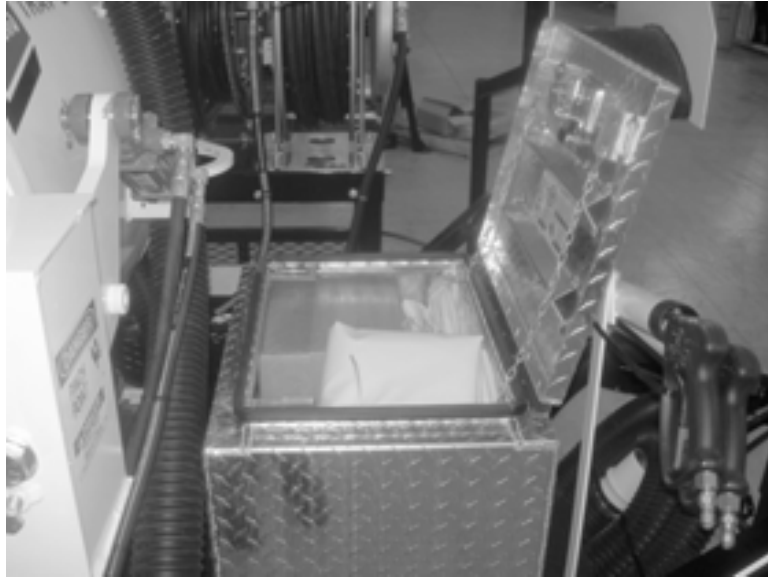

Figure 5-3. The optional job box is mounted at the front of the trailer.



Figure 5-4. Lift the handle and turn it to open the job box.

STARTING AND RUNNING THE ENGINE

The engine keyswitch must be in the ON position to operate any of the equipment on the VMT-1. Electrical demand from on board equipment can exceed the capacity of the trailer engine's charging circuit. This is especially true when moving and dumping the spoils tank. The supplied deep cycle battery provides sufficient reserve to allow temporary operation of all electrical accessories; however it is strongly recommended to run the engine at a minimum of 2800 rpm when using any electrical accessory. When moving the spoils tank, run the engine at this rpm for a period of 10 times usage to recharge the battery to the state before moving/dumping the tank (for example; if draining, dumping and stowage of the spoils tank takes two minutes, run the engine at 2800 rpm or more for at least 20 minutes). Use of other electrically powered accessories while recharging will lengthen the time required or prevent recharging of the battery. After heavy or long usage it may be necessary to charge the battery overnight to ensure proper charge level. If needed, only replace the trailer battery with a similar sized deep cycle battery.



NOTE

The engine **MUST** be running to operate the vacuum, pressure washer, either valve exerciser, or auxiliary hydraulic equipment.

Gas Engine

Use 87 octane unleaded gasoline or gasohol (10% ethanol/90% unleaded gas) in the engine. In cold weather, use winter blend fuel for easier starting.

Before using the engine, read the operating guidelines and instructions in the Kohler *Owner's Manual*.



NOTE

On sealed fuel tanks, use the vented fuel tank cap when using the VMT-1 in warm weather.

1. Check the gas tank to make sure that it has sufficient fuel for the job.
2. Set the choke lever (top lever) all the way on (to the left), as shown in Figure 5-5.
3. Set the throttle lever (bottom lever) midway between slow and fast, as shown in Figure 5-5.



Figure 5-5. To start the engine, set the choke lever (top) all the way to the left, and the throttle lever (bottom) in the middle.

4. Turn the key in the starter switch to the START position. Release the switch to the RUN position as soon as the engine starts.



Figure 5-6. Turn the engine key to START. Release it to RUN when the engine starts.

5. If the engine was warm before starting, set the choke lever to the OFF position. If the engine was cold, gradually move the choke lever to the OFF position as the engine warms up.
6. To shut the engine off, set the throttle to the low speed setting, then turn the key in the starter switch to the OFF position.

Diesel Engine

Use clean, fresh diesel fuel with a minimum of 40 cetane. In cold weather, allow the engine to warm up several seconds to several minutes, depending on the outside temperature.

Before using the engine, read the operating guidelines and instructions in the Briggs & Stratton Vanguard *Operator's Manual*.

1. Check the fuel tank to make sure that there is sufficient fuel for the job.



IMPORTANT

Do not crank the engine continuously for more than 10 seconds at a time. If the engine does not start, wait 60 seconds before trying to re-start it.



NOTE

On sealed fuel tanks, use the vented fuel tank cap when using the VMT-1 in warm weather.

2. When starting in cold weather, pull the throttle out to the fast speed setting. Otherwise, leave it pushed in for slow setting.

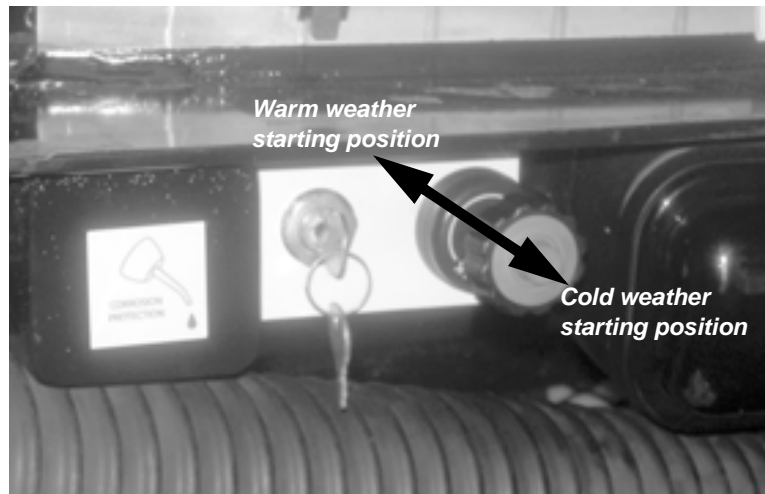

Figure 5-7. Push the throttle knob (at right) in to start the engine in warm weather; pull the knob out to start the engine in cold weather.

3. Turn the key in the starter switch to the right to engage the starter. Release the switch as soon as the engine starts.

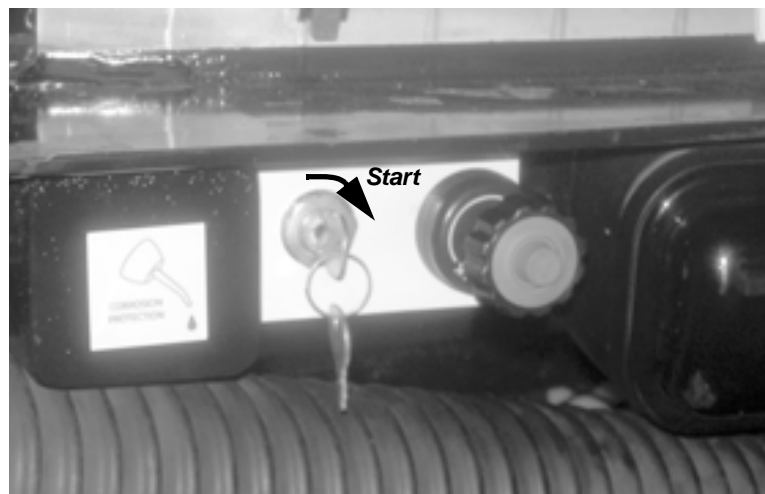

Figure 5-8. Turn the engine key to START. Release it to RUN when the engine starts.

4. To shut the engine off, push the throttle in to the slow speed setting, then turn the key in the starter switch to the left.



IMPORTANT

Do not crank the engine continuously for more than 10 seconds at a time, or for more than 30 seconds per minute.

VACUUM SYSTEM OPERATION

Selecting a Vacuum Wand

Vacuum wands of different diameters are available. A standard 3" (inside diameter) wand is provided with the vacuum system. A 1-1/4" wand is the most commonly used optional size. See Chapter 9 for a list of available wand sizes.

In general, use the largest wand possible for the work environment. Larger wands pick up more debris faster and are less likely to clog. Use a smaller wand when working in tight areas.

Setup and Operation

Before setting up the vacuum system, position the VMT-1 trailer so that the suction hose reaches the work area.

Ensure that the:

- latch on the dump door of the holding tank is fully engaged.
 - holding tank drain valve is closed.
 - vacuum break lever on the back of the trailer is in the CLOSED position.
1. Park the trailer on level ground near the work site so that the suction hose reaches the work area. Keep the trailer attached to the vehicle when operating the vacuum.
 2. Remove the suction hose from its storage location on the front of the trailer and lay it out on the ground.



NOTE

The standard suction hose is 20 feet long (longer length hoses can be ordered).



WARNING

Leave the trailer attached to the vehicle when operating the vacuum. A self-standing trailer could move as the vacuum tank fills, causing operator injury or damage to the equipment.

3. Release the locking collar holding the plug in the inlet port at the top of the spoils tank



Figure 5-9. Pull the latch on the locking collar to release it and take it off the inlet port.

4. Remove the plug from the inlet port. Place the plug in a secure location such as the trailer storage box.



Figure 5-10. Remove the plug from the inlet port.

5. Insert the port fitting end of the suction hose into the inlet port. Put the locking collar over the fitting and close the latch to secure the hose.



Figure 5-11. Insert the hose fitting into the inlet port and attach it with the locking collar.

6. Slide the other end of the hose over the vacuum wand. The hose will fit tightly. Insert the wand far enough to install the hose clamp.



Figure 5-12. Insert the wand fitting into the end of the vacuum hose.

7. Place the hose clamp around the hose; engage the latch and tighten it.

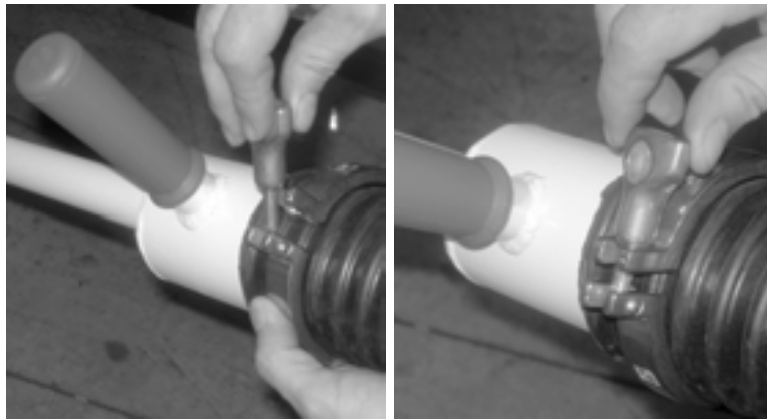

Figure 5-13. Attach the hose to the wand using the hose clamp.

8. Start the engine. Follow the instructions in “Starting and Running the Engine” earlier in this chapter.
9. Before turning on the vacuum blower, ensure that the wand is held off the ground and away from any objects.
10. At the control panel, turn the Vacuum/Pressure Washer switch to the VAC position. The vacuum blower will engage.



NOTE

Set the engine throttle to low speed before turning on the pressure washer or vacuum blower.



Figure 5-14. Turn the Vacuum/Pressure Washer switch to the VAC position.

11. When using the pressure washer to aid in vacuuming, turn the Vacuum/Pressure Washer switch to the BOTH position.



Figure 5-15. To use both the washer and vacuum, turn the Vacuum/Pressure Washer switch to the BOTH position.

12. Vacuum the work site to remove the water or debris. Note the following guidelines when operating the vacuum:
- When vacuuming water, do not submerge the tip of the wand. Skim the surface of the water with the wand to prevent opening the vacuum relief valves.
 - Monitor the vacuum pressure. Normal operation should have a vacuum level of about 5". If the filter or wand is clogged, the vacuum will rise to 11". Shut the vacuum off and check the filter, wand, and hose.
 - Vacuuming dry debris may be easier if the pressure washer is used to wet the material into a slurry.
 - The pressure washer may be used to "dig" around hydrants or other equipment to loosen and remove material.



Monitor the pressure on the vacuum gauge while operating the vacuum.

13. Monitor the fill level of the spoils tank by checking the sight glass on the front of the tank.

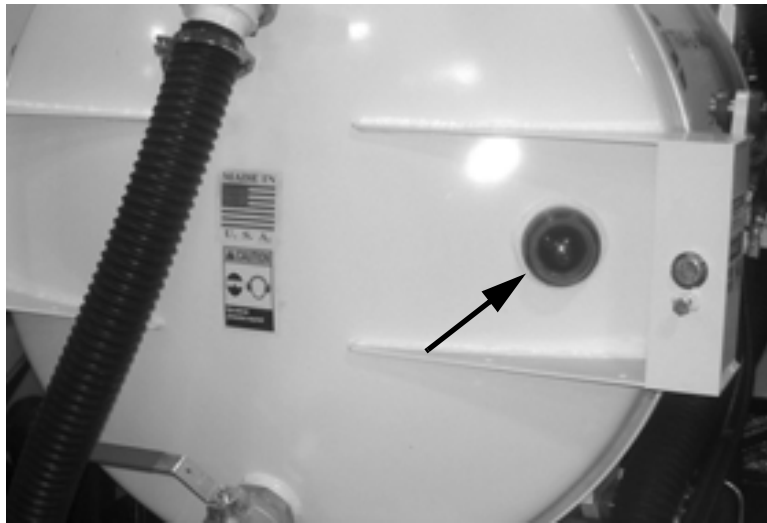

Figure 5-16. Monitor the fill level of the tank using the sight glass.



NOTE

A clogged wand or hose will also stop vacuum pressure. If the pressure stops and the tank is not full, see the instructions in the “Unclogging the Vacuum” section below.

14. When the tank fills with liquid, a ball valve in the top of the tank shuts off the vacuum pressure. (The relief valves in the filter canister will open.) See the instructions in the next section, “Emptying the Tank”.
15. When vacuuming is completed or when the vacuum pressure stops, turn the Vacuum/Pressure Washer switch to the OFF position.



Figure 5-17. Turn the Vacuum/Pressure Washer switch OFF to turn off the vacuum.

16. Turn off the gas engine using the keyswitch.
17. Remove the wand from the suction hose and put it in the trailer's accessory storage cradle.
18. Remove the hose from the tank inlet port and replace it on the front of the trailer.
19. Re-insert the plug in the inlet port and secure it with the locking collar.

Emptying the Tank

When emptying the tank, follow the appropriate procedure below for draining liquids or dumping solids from the tank.

Draining Liquid

1. Move the trailer to the dumping location. Ensure that there is clearance around the trailer.
2. Start the gas engine. Follow the instructions in "Starting and Running the Engine" earlier in this chapter.
3. Move the tank past the trailer deck. At the control panel, turn and hold the Dump Switch to the UP position just until the tank has cleared the deck and begins to tip (approximately 10° - 20°), then release the Dump Switch to the center position.



NOTE

The tank moves out 12" before it tips for dumping, and the door swings out when opened. Allow sufficient clearance beside the trailer.



WARNING

Ensure that no one is in front of or near the tank when operating the Dump Switch. Contact with the tank while it is moving could cause serious injury.



Figure 5-18. Turn the Dump Switch to the UP position and hold it just until the tank has cleared the deck and begins to tip. Tip the tank approximately 10° - 20° .

4. Open the tank drain valve to allow liquid to drain.



Figure 5-19. Open the tank drain valve.

5. When the liquid has finished draining, check the tank drain valve for obstructions before closing.

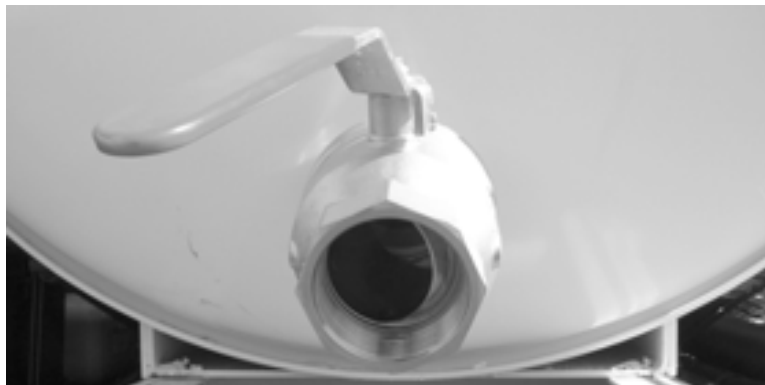

Figure 5-20. Check the drain valve before closing.

6. Close the tank drain valve.



Figure 5-21. Close the tank drain valve.



NOTE

If the valve is blocked with solids and the liquid won't drain, it is easiest to dump the tank to empty it. Stand clear of the tank when dumping liquids; the tank contents will splash out when the door is opened.

7. If solids remain in the tank, proceed to Step 4 of Dumping Solids (page 63). Otherwise, when all fluids have drained and the valves are closed, return the tank to the operating position. At the control panel, turn the Dump Switch to the DOWN position and hold it until the tank has lowered and moved back to the operating position. Release the Dump Switch.

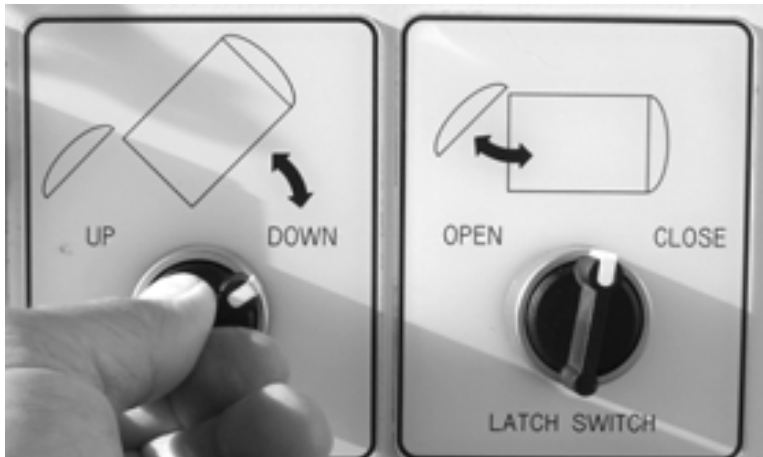

Figure 5-22. Once the fluids have drained and the valves are closed, turn the Dump Switch to the DOWN position until the tank has moved back to its operating position.

8. After dumping or moving the spoils tank, allow sufficient time to recharge the trailer battery before turning off the engine. Refer to “Starting and Running the Engine”(page 49) for a more detailed explanation of re-charge times.



CAUTION

Park the trailer on level ground before dumping. The door may not close if the trailer is not level.



WARNING

Ensure that no one is in front of or near the tank when operating the Dump Switch. Contact with the tank while it is moving could cause serious injury.

Dumping Solids

When the tank contains both liquids and solids, it may be appropriate to partially drain the liquid (using the previous procedure) prior to dumping the solids. However, a moderate amount of liquid may facilitate dumping the solids.

1. Move the trailer to the dumping location. Ensure that there is clearance around the trailer and sufficient area for the tank to open and dump.
2. Start the gas engine. Follow the instructions in “Starting and Running the Engine” earlier in this chapter.
3. Move the tank past the trailer deck. At the control panel, turn and hold the Dump Switch to the UP position just until the tank has cleared the deck and begins to tip (approximately 10° - 20°), then release the Dump Switch to the center position.

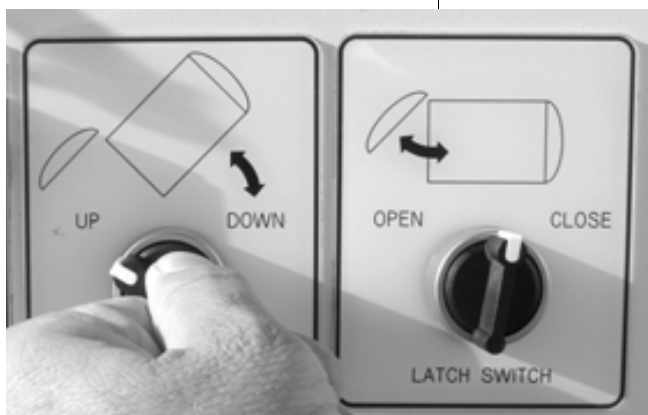

Figure 5-23. Turn the Dump Switch to the UP position and hold it just until the tank has cleared the deck and begins to tip (approximately 10° - 20°).

4. At the control panel, turn the Latch Switch to the OPEN position and hold it until the door opens.

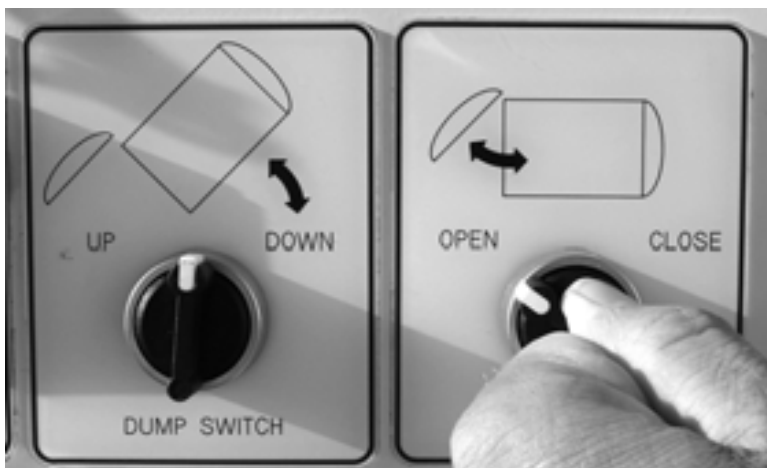

Figure 5-24. Turn the Latch Switch to the OPEN position and hold it until the door swings open.



Figure 5-25. The tank door will swing open when the latches are released.



WARNING

Make sure no one is in front of or near the tank when operating the Latch Switch. Contact with the tank door or contents when the door opens could cause serious injury.



CAUTION

Monitor the door position when tilting the tank. In certain situations the door may contact the ground which could damage the door.



WARNING

Make sure no one is near the tank when operating the Dump and Latch Switches. Contact with the tank or door when they are moving could cause serious injury.

5. Once the tank door is open, turn the Dump Switch to the UP position and hold it until the tank is completely tipped.

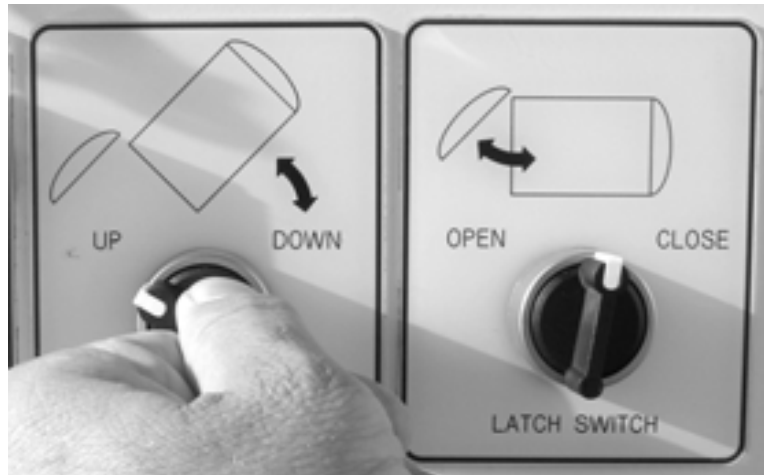

Figure 5-26. After opening the tank door, turn the Dump Switch to the UP position to completely tip the tank.



Figure 5-27. Tank in the fully tipped position.

6. After the tank contents have dumped and the door has stopped swinging, check the inside of the tank for remaining debris. Remove debris with the power washer, or use a shovel to scrape it out if necessary.
7. Use the power washer to clean the rim of the door and the edge of the tank. This will ensure that the tank door will seal properly when it is closed.

8. At the control panel, turn the Dump Switch to the DOWN position and hold it until the tank has lowered and moved back to its operating position. Release the Dump Switch.

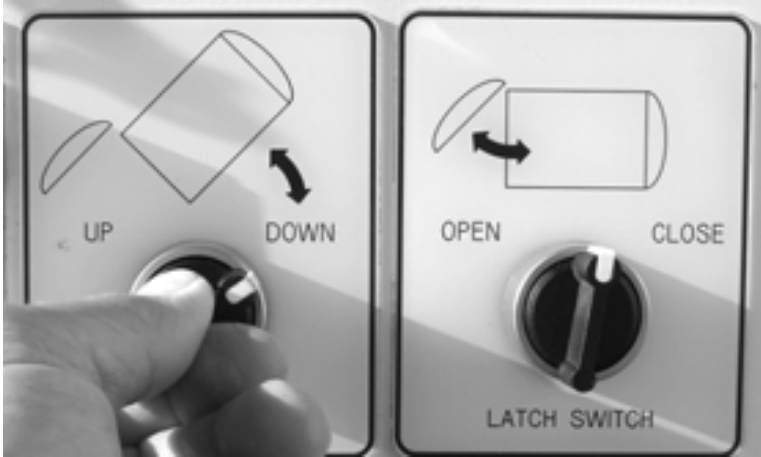

Figure 5-28. After the tank is dumped, turn the Dump Switch to the DOWN position until the tank has moved back to its operating position.

9. Ensure that the door is in contact with the tank before operating the Latch Switch.
10. At the control panel, turn the Latch Switch to the CLOSE position and hold it until the latches on the door completely engage.



Figure 5-29. When the tank is in the down position, turn the Latch Switch to the CLOSE position until the latches are fully engaged.



CAUTION

Make sure the tank is lowered to the level position before closing the door. Closing the door latches before leveling the tank can damage the latch mechanisms.

**NOTE**

Check the filter whenever the vacuum system becomes clogged. Reduced suction caused by a partially clogged filter can cause the hose to clog. Clean the filter if necessary.

11. After dumping or moving the spoils tank, allow sufficient time to recharge the trailer battery before turning off the engine. Refer to “Starting and Running the Engine” (page 49) for a more detailed explanation of re-charge times.

Unclogging the Vacuum

If the system loses suction and the tank is not full, there is either a clog in the wand or hose, or the filter is plugged. If the suction stops suddenly, a clog is the most likely cause. A gradual decrease of suction is generally caused by a plugged filter.

Use the following procedure to clear the clog. Instructions for cleaning the filter are in Chapter 6.

1. With the vacuum running, turn the Vacuum Break lever to the CLOSED position, then return it to the OPEN position. This may dislodge the clog.

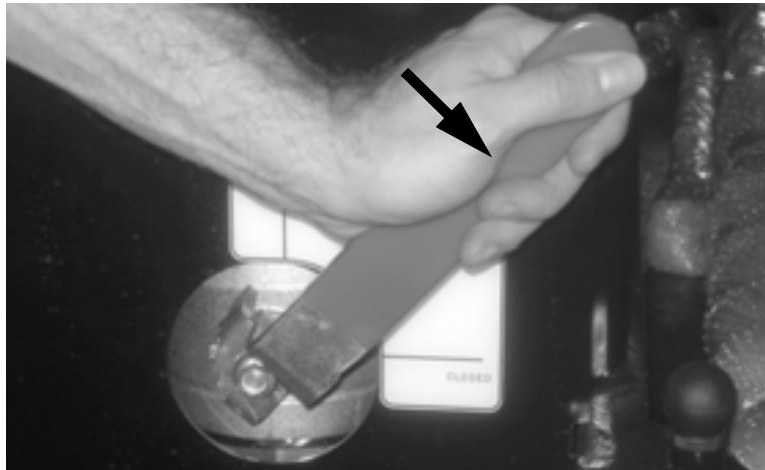

Figure 5-30. Turn the Vacuum Break lever to the CLOSED position.

2. Repeat opening and closing the Vacuum Break lever once or twice to see if the clog dislodges.

3. If using the Vacuum Break lever does not dislodge the clog, return the lever to the OPEN position. Turn the Vacuum/Pressure Washer switch to the OFF position to turn off the vacuum.



Figure 5-31. Turn the Vacuum/Pressure Washer switch OFF to turn off the vacuum.

4. Remove the wand from the hose and look through it to check for an obstruction. If it is blocked, use a rod or similar tool in the connector end of the wand to push out the obstruction.
5. If the wand is not clogged, remove the hose from the inlet port and check it. Try using the pressure washer from the tank end of the hose to spray out the clog, or use a long rod or similar tool to push the clog out of the hose.
6. After the clog has been removed, reconnect the wand to the hose. Spray water into the tank end of the hose to ensure that the wand is functioning properly.
7. Reconnect the hose to the inlet port on the tank.

PRESSURE WASHER OPERATION

Before operating the pressure washer, ensure that:

- there is water in the washer reservoir
- there is antifreeze in the antifreeze reservoir (if the temperature will be below freezing)
- the Water Supply Valve lever is in the TANKS position.

See Chapter 4 for instructions on storing the pressure washer in sub-freezing weather.

Filling the Water Tank

The water tank can be accessed from the rear of the trailer on the right side. Unscrew the cap to fill the tank.

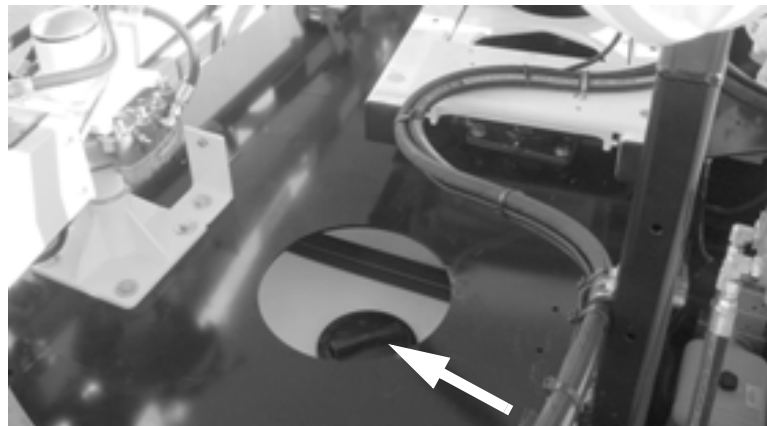

Figure 5-32. The lid to the water tank is below the rear deck of the trailer.

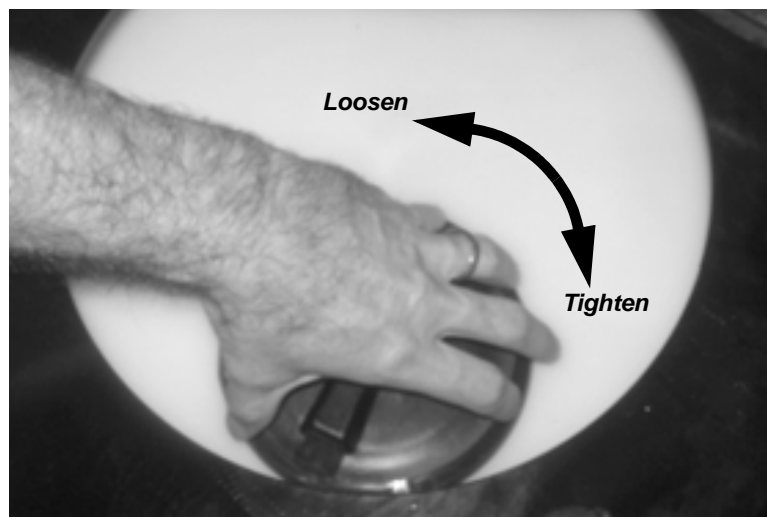

Figure 5-33. Remove the cap to fill the water tank.

Filling the Antifreeze (Primer) Tank

The priming tank is next to the engine on the trailer. Unscrew the cap and fill the tank before using the sprayer.

- When operating the sprayer in below-freezing or near-freezing weather, keep the priming tank filled with an antifreeze mixture appropriate for the temperature.
- When there is no danger of freezing temperatures, plain water may be used in the priming tank. A water treatment solution may be used to keep the sprayer system clean.

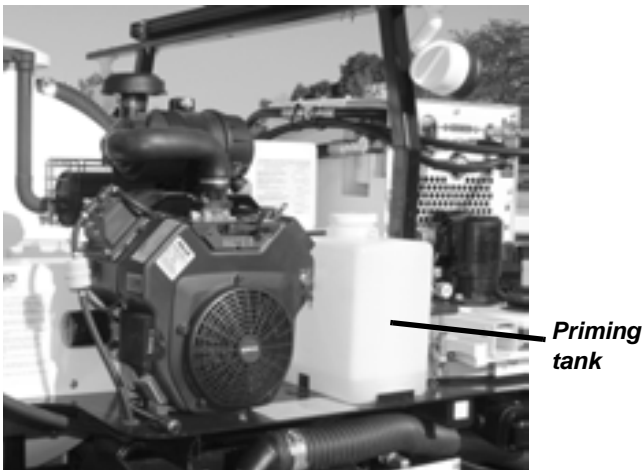

Figure 5-34. Fill the priming tank with either anti-freeze (when using the system in freezing weather) or water treated with a purifying agent (when using the system in non-freezing weather.)



NOTE

Propylene glycol (PG) anti-freeze comes in two types, motor vehicle and RV/Marine. These antifreezes are intended for completely different end uses. **Use only RV/Marine antifreeze in the sprayer system.** When cycling antifreeze out of the system, do not dump anti-freeze on the ground or into storm water drains. Cycle it back into the priming tank, then remove the priming tank and dispose of the antifreeze in an approved manner.

Using the Pressure Washer

The short sprayer wand is recommended for washing the trailer or cleaning other equipment. The longer wand is useful for cleaning at the work site or scouring soil and debris while vacuuming.

1. Pull a sufficient length of sprayer hose from the hose reel to reach the work location.



NOTE

The sprayer hose is 50 feet long. The hose reel has a ratchet lock; pull the desired length of hose and stop when the ratchet clicks.



Figure 5-35. Pull the sprayer hose out of the hose reel until it reaches the work location.

2. Select the appropriate sprayer wand and attach it to the end of the sprayer hose.



Figure 5-36. Attach the spray wand to the sprayer hose.

3. Start the gas engine and run at low to medium throttle.
4. At the control panel, turn the Vacuum/Pressure Washer switch to the WATER position.



Figure 5-37. Turn the pressure washer switch to the WATER position.

5. When using both the pressure washer and vacuum, turn the Vacuum/Pressure Washer switch to the BOTH position.



Figure 5-38. To use both the washer and vacuum, turn the Vacuum/Pressure Washer switch to the BOTH position.

6. Squeeze the trigger on the spray wand to start spraying.



NOTE

Set the engine throttle to low speed before turning on the pressure washer or vacuum blower.



NOTE

Pressure is set at the factory to 3,000 psi. Adjust the unloader valve only as required.

7. Adjust the sprayer pressure by turning the unloader knob on the sprayer pump.

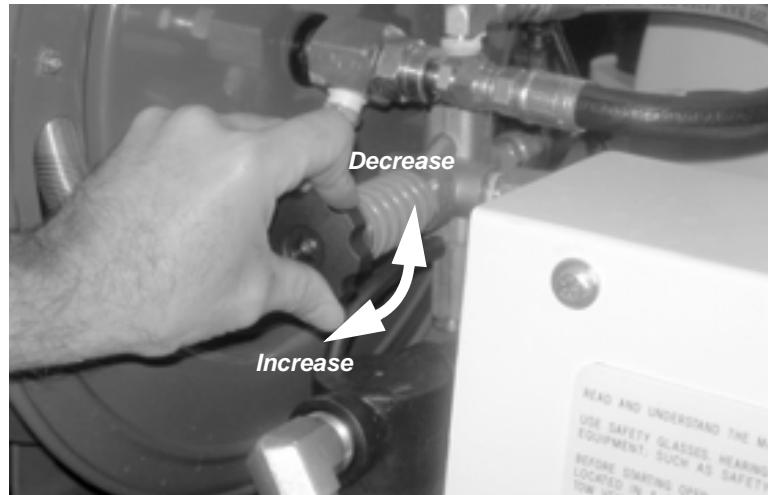

Figure 5-39. Turn the unloader knob clockwise to increase the water pressure, or counter-clockwise to decrease water pressure.

8. Monitor the water level in the water tank while using the sprayer. Refill the tank when necessary. If the tank runs dry and the pump loses its prime, follow the priming procedure in the next section.
9. When finished spraying, turn the Vacuum/Pressure Washer switch to the OFF position.



Figure 5-40. Turn the Vacuum/Pressure Washer switch OFF when finished spraying.

Priming the Washer Pump

The washer pump may require priming if the tank runs dry, or if the system is drained because of a leak or service. The pump can be primed by using its own suction or using an external pressurized water source.

Prime Using the VMT-1 Pump Draw

1. Fill the main water tank with water.
2. Fill the priming tank with water. (The fluid level in the priming tank must be higher than the pump.)

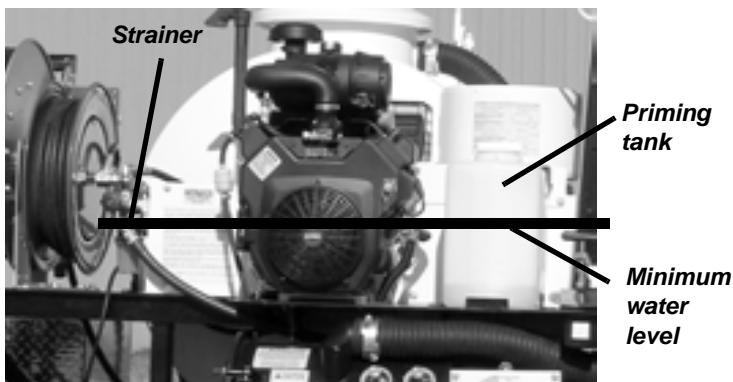

Figure 5-41. Fill the priming tank so that the water level is above the pump.

3. Move the yellow Water Supply Valve lever (in front of the left fender) to the ANTIFREEZE/CHARGE TANK position.



Figure 5-42. Move the Water Supply Valve to the ANTIFREEZE/CHARGE TANK position.



NOTE

Any loose or cracked fittings, or air trapped in the suction line, will prevent the water pump from operating correctly.



CAUTION

Do not move the Water Supply Valve lever when the pump is running. Damage to the pump can result.



NOTE

Trailers built *before* September 2008 have a strainer in the water line. Trailers built *after* September 2008 have a strainer in the fresh water tank. You will not need to perform this step if there is no strainer in the water line.

4. Pull a sufficient length of hose from the sprayer hose reel to reach the priming tank. Put the end of the sprayer hose into the top of the tank to cycle the anti-freeze to prime the system.
5. Loosen the clear plastic water strainer until fluid fills the bowl, then retighten. (The suction supply line should now be primed from the priming tank to the strainer housing.)

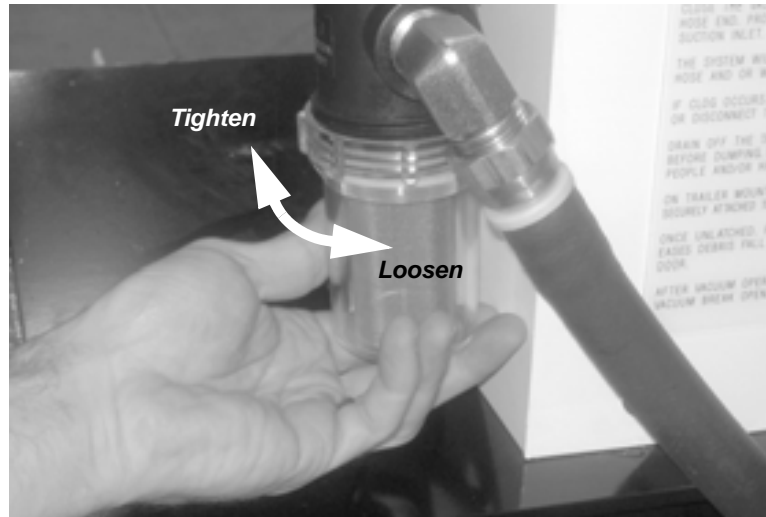

Figure 5-43. Loosen the strainer until water fills the bowl, then retighten it.

6. Turn the unloader knob counter-clockwise to release all spring tension.

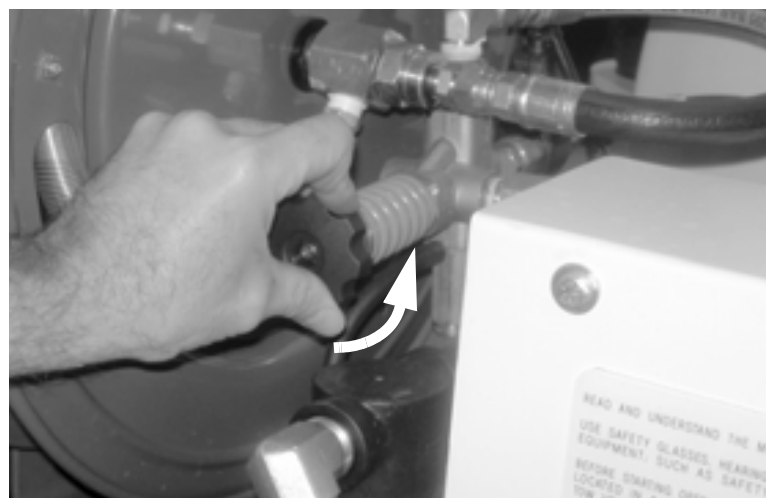

Figure 5-44. Turn the unloader knob counter-clockwise until the spring tension is released.

7. Start the gas engine and run at low to medium throttle.
8. At the control panel, turn the Vacuum/Pressure Washer switch to the WATER position. Water will begin to flow from the end of the sprayer hose.



Figure 5-45. Turn the pressure washer switch to the WATER position.

9. Turn the unloader knob clockwise to increase flow. Increase engine speed as needed.

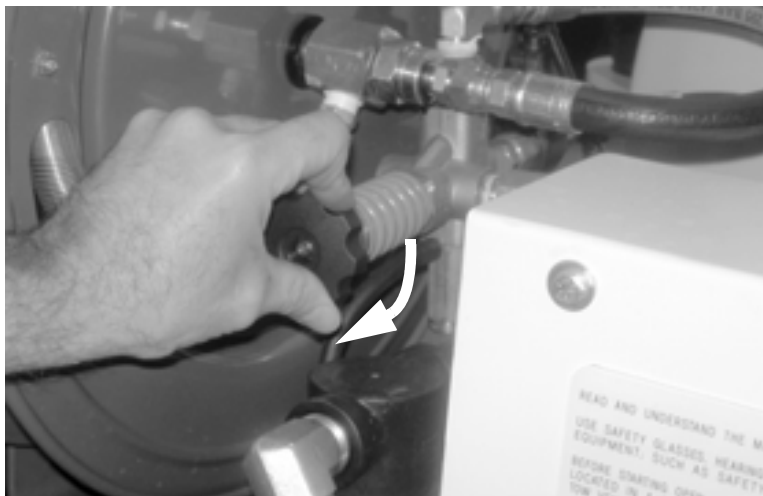

Figure 5-46. Turn the unloader knob clockwise to increase the water flow.

10. Let the water continue to flow until it is a steady flow, without air bubbles. This may take 3-5 minutes.



NOTE

Set the engine throttle to low speed before turning on the pressure washer or vacuum blower.



CAUTION

Do not move the Water Supply Valve lever when the pump is running. Damage to the pump could result.

11. Move the yellow Water Supply Valve lever to the TANKS position. This will prime the main tank and allow continued operation.

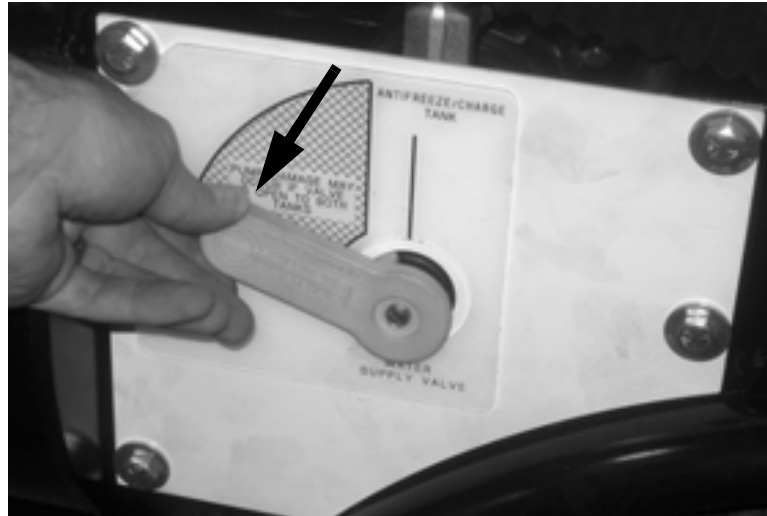

Figure 5-47. Move the Water Supply Valve lever to the TANKS position to prime the main tank.

Prime Using a Pressurized Water Source

1. Connect a garden hose using a female adapter to the brass drain valve at the back of the trailer.



NOTE

The water source must be capable of supplying at least 4 gallons per minute.

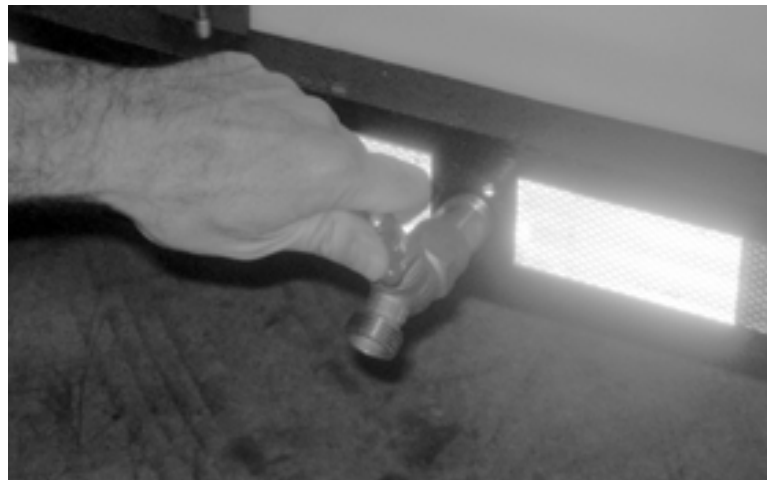

Figure 5-48. Connect a garden hose to the drain valve on the back of the trailer.

2. Pull a sufficient length of hose from the sprayer hose reel to reach the water tank. Put the end of the sprayer hose into the top of the tank to cycle the water as the system is primed.
3. Close the plastic tank valve located under the lower deck behind the trailer's axle.

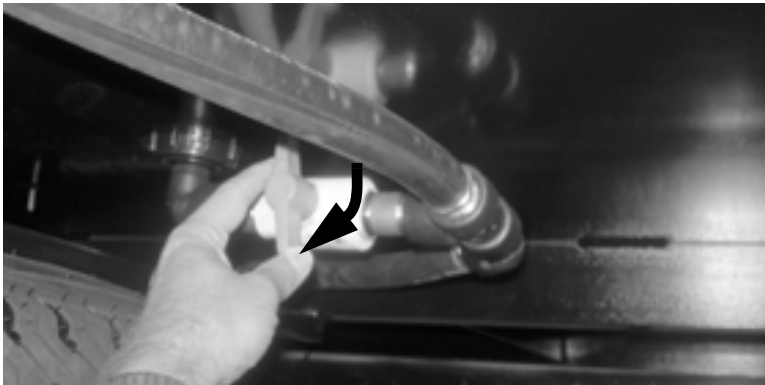

Figure 5-49. Turn off the tank valve underneath the trailer.

4. Move the yellow Water Supply Valve lever to the TANKS position.

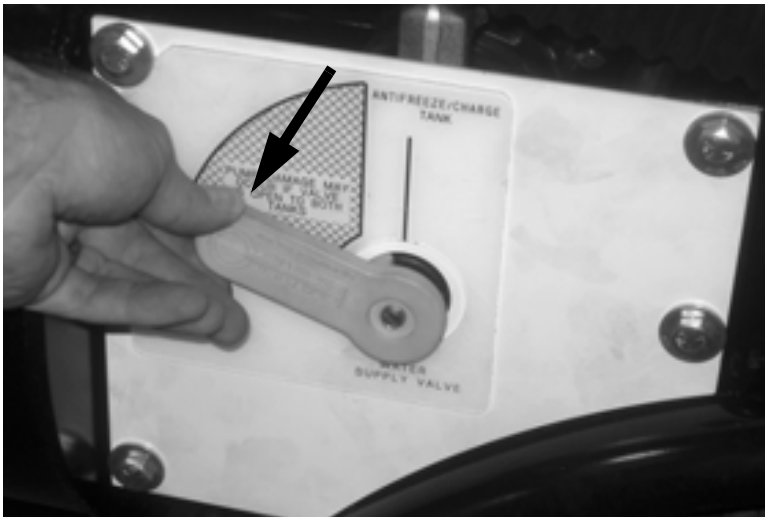

Figure 5-50. Move the Water Supply Valve lever to the TANKS position.

5. Turn on the garden hose.



NOTE

The maximum inlet pressure of the pump is 125 psi. Do not exceed this pressure with the water source.



NOTE

Trailers built *before* September 2008 have a strainer in the water line. Trailers built *after* September 2008 have a strainer in the fresh water tank. You will not need to perform this step if there is no strainer in the water line.

6. Loosen the clear plastic water strainer until fluid fills the bowl, then retighten. (This will prime the main line all the way to the pump.)

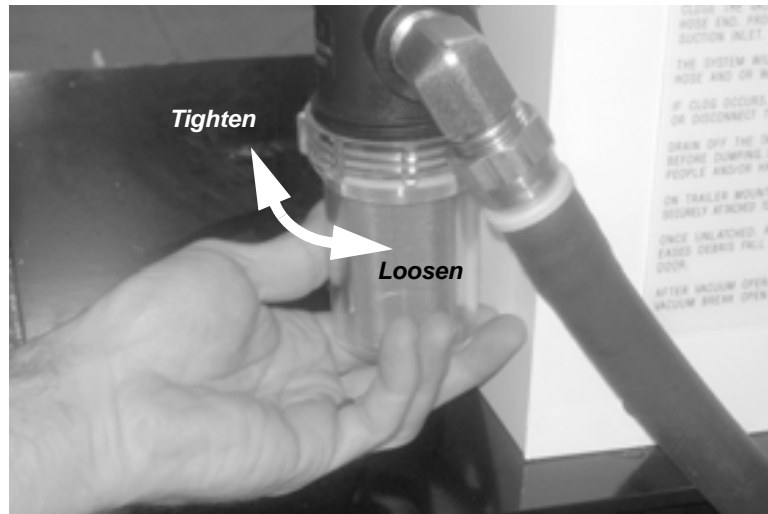

Figure 5-51. Loosen the strainer until water fills the bowl, then retighten it.

7. Turn the unloader knob counter-clockwise to release all spring tension.

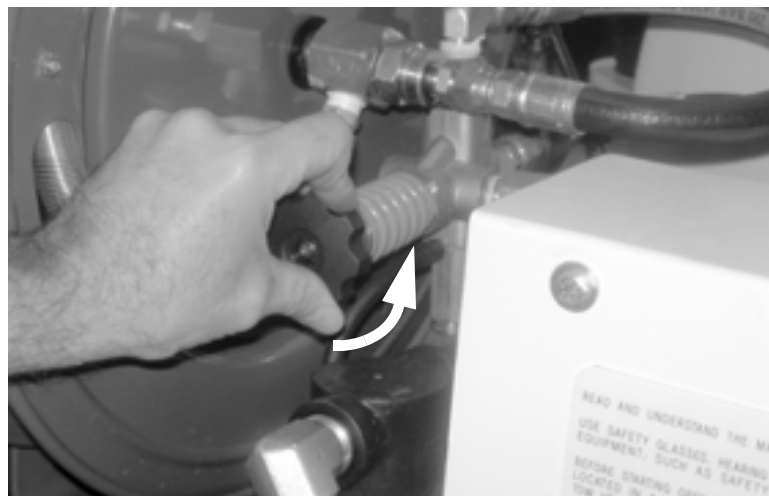

Figure 5-52. Turn the unloader knob counter-clockwise until the spring tension is released.

8. Start the engine and run it at low to medium throttle.

9. At the control panel, turn the Vacuum/Pressure Washer switch to the WATER position. Water will begin to flow from the sprayer hose.



Figure 5-53. Turn the pressure washer switch to the WATER position.

10. Turn the unloader knob clockwise to increase pressure. Increase engine speed as required.

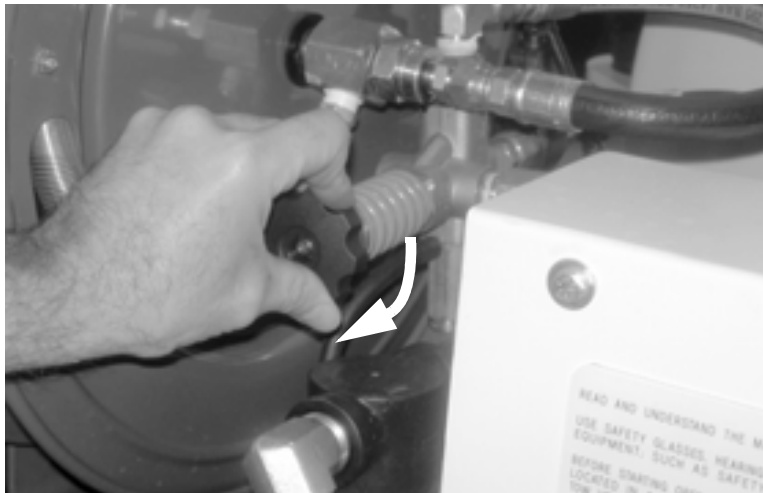

Figure 5-54. Turn the unloader knob clockwise to increase the water pressure.

11. To operate the sprayer using the external water source, attach a spray wand to the sprayer hose. The sprayer can be operated for an extended time in this configuration.



NOTE

Set the engine throttle to low speed before turning on the pressure washer or vacuum blower.

LIGHT BAR OPERATION

The light bar controller is mounted in a water-tight enclosure on the side of the trailer above the fender.



Figure 5-55. The controller for the light bar is inside a water-tight enclosure on the side of the trailer.

1. To access the controller, open the enclosure by pulling the top of the front cover forward.



Figure 5-56. Pull the top of the enclosure cover forward to open it.

2. Press the POWER button to turn on the light bar.
3. At night, push in the NIGHT button for low-intensity light mode.

4. Set the knob to change the light bar display, as illustrated below.

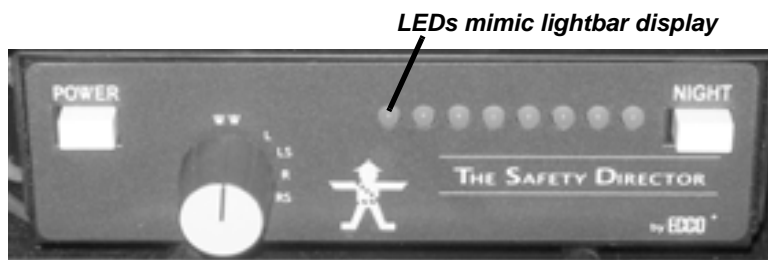

Figure 5-57. Turn the knob on the lightbar controller to set the following modes:

WW	Wig wag (alternate inside/outside)
L	Left arrow
LS	Left arrow solid
R	Right arrow
RS	Right arrow solid

5. Close the front cover when not setting the controls. To turn off the light bar, press the POWER button.

HYDRAULIC HOSE REEL OPERATION

VMT-1 trailers with both the hydraulic hose reel and the ERV-750 valve exerciser must share the auxiliary hydraulic circuit. Disconnect the ERV-750 to use the hydraulic hose reel.

1. If necessary, remove the ERV-750 hoses from the auxiliary ports on the front of the hydraulic tank. Cap the hose ends.

2. The hose reel connection hoses are stored beneath the back of the trailer. Remove the strap holding the hoses and unroll the hose ends.



Figure 5-58. The hose connections to the hydraulic hose reel are stored under the trailer between the storage box and water tank. Remove the strap to take the hoses out and connect them.

3. Connect the hoses to the auxiliary ports on the front of the hydraulic tank.



Figure 5-59. Remove the hoses from beneath the back of the trailer and connect them to the auxiliary ports on the front of the tank.

4. Pull out the auxiliary knob on the tank to enable hydraulic flow through the auxiliary ports.



Figure 5-60. Pull the auxiliary knob on the front of the hydraulic tank.

5. Pull a sufficient length of hose from the hydraulic hose reel to reach the work location.



Figure 5-61. Pull the hydraulic hose pair off the hose reel to the work location.

6. Connect the hoses to the hydraulic tool. Tools with flow controls must be turned off.



NOTE

The hydraulic hoses are 45 feet long. The hose reel has a ratchet lock; pull the desired length of hose, then stop when the ratchet clicks.

7. Start the gas engine. Set the throttle so that the system pressure gauge on the front of the hydraulic tank displays the pressure required for the tool to be operated.



WARNING

The water heater gets very hot. Stay away from the top vent of the heater unit when operating the heater. Contact with the heater may cause severe burns.

WATER HEATER OPERATION

A valve and a hose inlet on the water heater allow the water heater to be operated in three configurations:

- spraying hot water with the sprayer hose
- circulating water from the heater to the tank
- circulating water from the heater through the entire sprayer system.

NOTE: With the water heater installed, water to the sprayer is always circulated through the water heater. The water will be heated only if the heater is turned on.

Starting and Running the Water Heater

1. Fill the heater's diesel fuel tank.



Figure 5-62. The water heater fuel tank is mounted in front of the heater.

2. Start the gas engine and set it to medium throttle.
3. At the control panel, turn the Vacuum/Pressure Washer switch to the WATER position.



Figure 5-63. Turn the pressure washer switch to the WATER position.

4. Flip the power switch on the water heater control box to the up position.



Figure 5-64. Push the power switch up to turn on the water heater.



NOTE

The water heater has a flow check that detects water flowing into the heater. If there is no flow, the heater will automatically turn off.

5. Set the thermostat on the water heater control box to the desired temperature.



Figure 5-65. Set the water heater thermostat.

6. The heater will heat the water to the temperature on the thermostat. The burner will then cycle off and on as necessary to maintain that temperature.
7. To turn the water heater off, push the switch on the control box down.



Figure 5-66. Turn the water heater off by pressing the switch down.

Spraying Hot Water

See “Pressure Washer Operation” in this chapter for instructions on operating the sprayer. To set the water heater valve:

1. Turn the water heater valve handle as shown in Figure 5-67 below to direct the water flow to the sprayer.

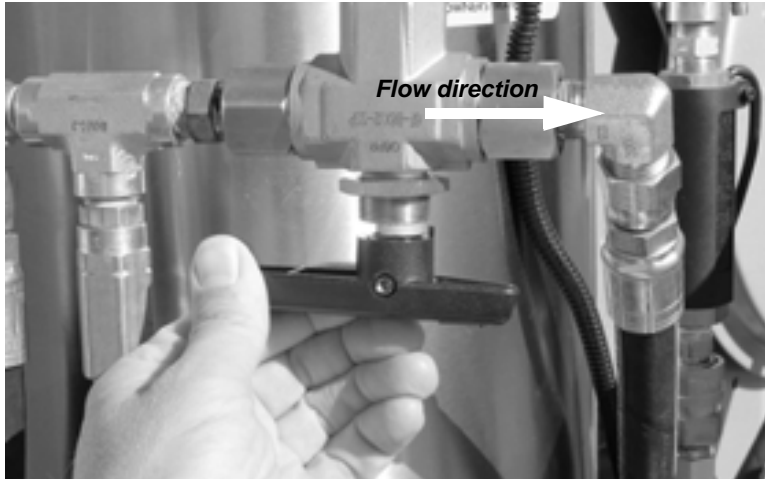

Figure 5-67. The water flow through the water heater valve is toward the shorter end of the handle. To spray hot water, set the water flow to the right.

2. Operate the sprayer as usual. It may take a few seconds for hot water to reach the spray wand.



NOTE

The gas engine must be running and the Vacuum/Pressure Washer switch set to WATER.

Heating the Tank Water

Water can be heated and circulated directly back to the water tank. The sprayer cannot be used while heating and recirculating water.

1. Turn the water heater valve handle as shown in Figure 5-68 below to direct the water flow back to the water tank.

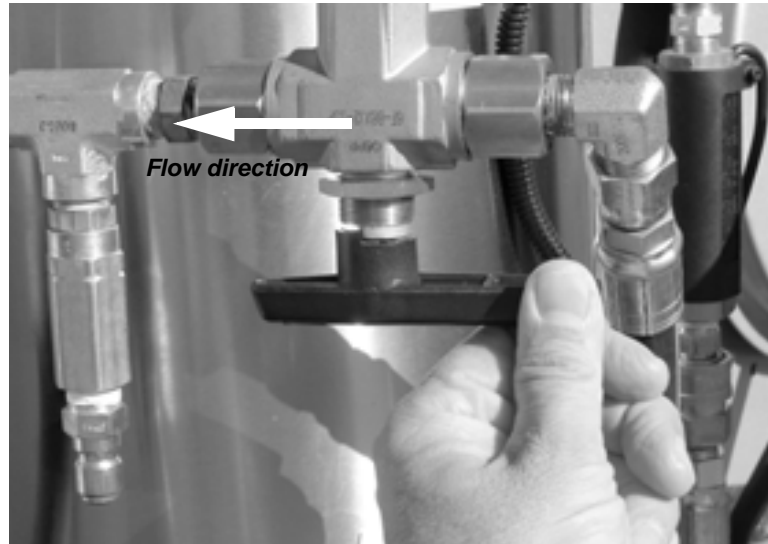

Figure 5-68. Set the water flow direction to the left to heat the tank water. (This setting disables the sprayer.)

2. The heater will operate until the water reaches the temperature on the thermostat, then automatically turn off.

Circulating Hot Water

Heated water can be circulated through the entire sprayer system. The sprayer cannot be used while heating and recirculating water.

1. Pull a sufficient length of hose from the pressure washer hose reel to reach the valve on the water heater. Do not connect the spray wand.



Figure 5-69. Pull enough hose out of the sprayer reel to reach the front of the water heater.

2. Connect the pressure washer hose to the input valve as shown in Figure 5-70.



Figure 5-70. Connect the hose from the reel to the inlet on front of the water heater.



NOTE

The gas engine must be running and the Vacuum/Pressure Washer switch set to WATER.

3. Turn the water heater valve handle as shown in Figure 5-71 below to direct the water flow through the sprayer system.

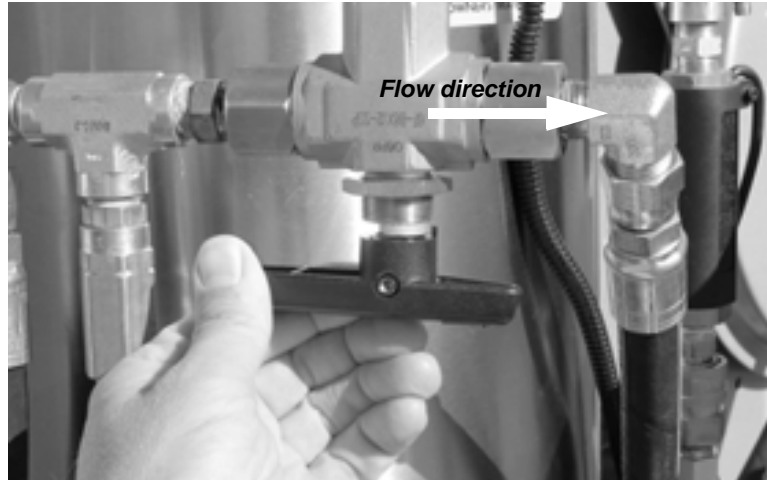

Figure 5-71. Set the flow direction to the right to circulate hot water throughout the sprayer system.

4. The heater will cycle the burner off and on as necessary to maintain the temperature on the thermostat.

VALVE EXERCISER

The engine must be running in order to operate either of the valve exercisers.

Operating the TM-7

This section describes how to set up the TM-7 for use. Detailed instructions on operating the TM-7 are in the *TM-7 Truck Mounted Valve Exerciser User's Manual*, which is provided with the TM-7.

The TM-7's hydraulic system is plumbed directly to the hydraulic tank.

1. Push in the auxiliary knob on the hydraulic tank to enable hydraulic flow through the valve exerciser ports.



Figure 5-72. Push in the auxiliary knob to enable flow to the TM-7.

2. To swivel the TM-7, loosen both swivel clamps by turning the knobs counter-clockwise.



Figure 5-73. Turn the swivel clamp knob counter-clockwise to loosen the clamp. There is a clamp on each side of the TM-7.



CAUTION

On trailers equipped with both a TM-7 and an ERV-750, you will need to swing the ERV-750 arm out of the way before swiveling the TM-7.



NOTE

When operating the TM-7 from its standard “parked” position, it is not necessary to loosen the swivel clamps or remove the locking pin.



NOTE

On trailers equipped with both a TM-7 and an ERV-750, the TM-7 will swivel only 90° to the back of the trailer.

3. Pull out the locking pin underneath the TM-7.

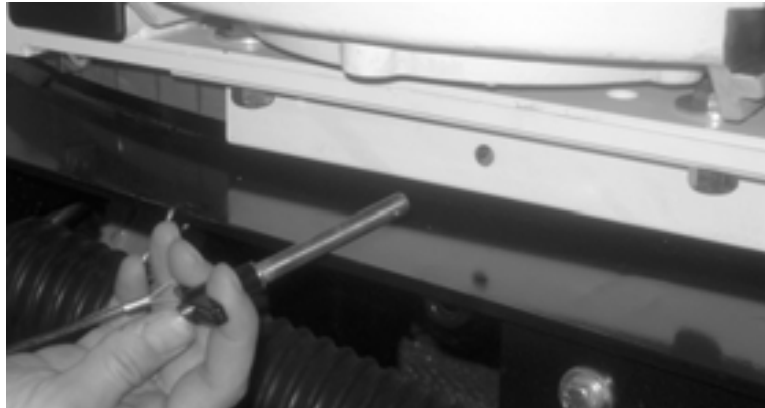

Figure 5-74. Pull out the locking pin holding the TM-7 to the frame. Replace the pin in the frame after moving the TM-7.

4. Move the TM-7 to the desired position. Turn the swivel clamp knobs clockwise to lock the TM-7 in place.

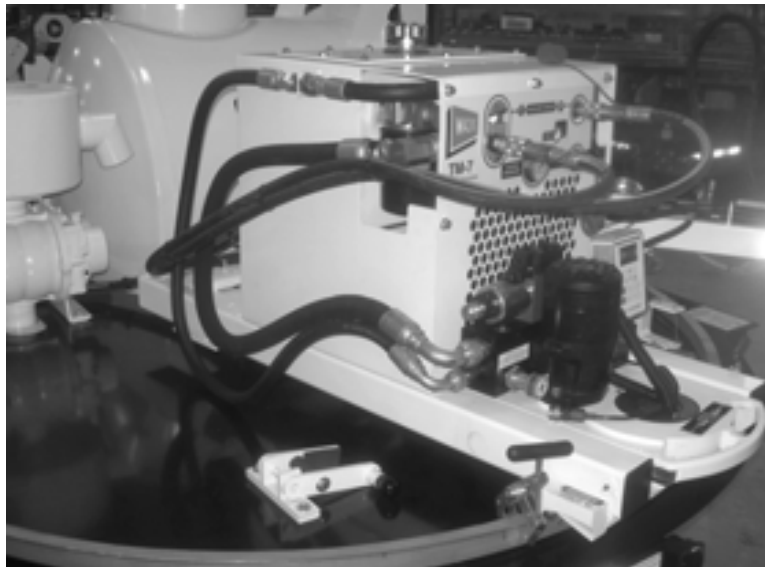

Figure 5-75. Swivel the TM-7 along the rail to the desired position, then tighten the swivel clamps.

5. If the trailer is also equipped with an ERV-750, a stop bracket with a rubber bumper prevents the TM-7 from traveling past 90°.



Figure 5-76. On trailers equipped with both a TM-7 and an ERV-750, a stop bracket with a rubber bumper prevents the TM-7 from swiveling too far.

6. Operate the TM-7 according to the instructions in the *Truck Mounted Valve Exerciser, Model TM-7* manual.
7. When finished using the TM-7, return it to its “parked” position. Tighten the swivel clamps and reinsert the locking pin.



WARNING

Make sure the swivel clamps are tightened before operating the TM-7. The machine could move suddenly when actuated, causing operator injury.

Operating the ERV-750

This section describes how to set up the ERV-750 for use. Detailed instructions on operating the ERV-750 are in the *ERV-750 Extended Reach Valve Exerciser User's Manual*, which is provided with the ERV-750.

Trailer Systems without a TM-7

For VMT-1 trailers **without** a TM-7, the ERV-750 is plumbed directly to the hydraulic tank. The ERV-750 does not require any additional hoses.

1. Push in the auxiliary knob on the hydraulic tank to enable hydraulic flow through the valve exerciser ports.



Figure 5-77. Push in the auxiliary knob to enable flow to the ERV-750.

Trailer Systems With a TM-7

1. For VMT-1 trailers **with** a TM-7, connect the hoses from the ERV-750 to the auxiliary hydraulic ports on the front of the hydraulic tank.

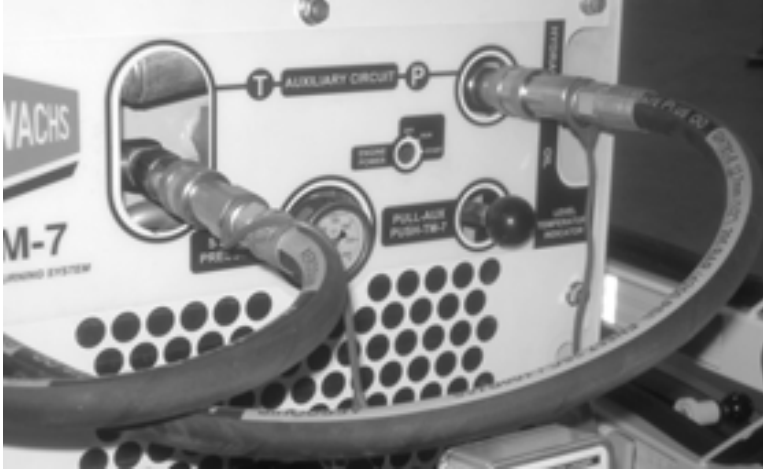

Figure 5-78. Connect the hoses from the ERV-750 to the hydraulic tank (systems with TM-7 also). Connect the pressure-side hose to the “P” connector and the return (tank) hose to the “T” connector.

2. Pull out the auxiliary knob on the tank to enable hydraulic flow through the auxiliary ports.



Figure 5-79. Pull the auxiliary knob on the front of the hydraulic tank.

**NOTE**

For trailers with the hydraulic hose reel option, it may be necessary to disconnect the hydraulic hose reel from the tank. On trailers with both a TM-7 and ERV-750, the ERV-750 and hydraulic hose reel share the auxiliary circuit.

3. Unfasten the latches that hold the ERV arm to the trailer.

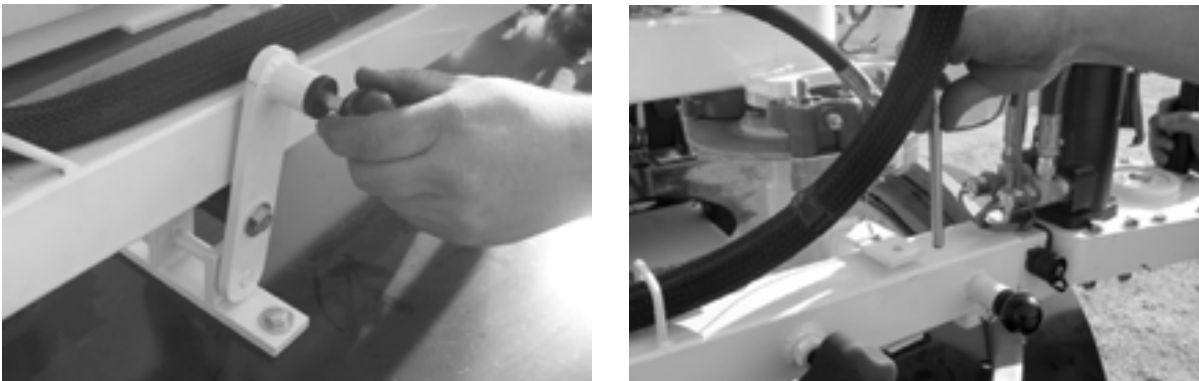

Figure 5-80. Release the two latches that secure the ERV-750 arm to the trailer.

4. Operate the ERV-750 according to the instructions in the *ERV-750 Extended Reach Valve Exerciser User's Manual*.
5. When finished using the ERV-750, return the arm to the storage position and fasten it with both latches.

Chapter 6

Routine Maintenance

.....

For maintenance on the engine, axles, brakes, and any optional equipment such as the water heater or valve exercisers refer to the individual manuals supplied with those components. Perform all maintenance procedures recommended by the manufacturers.

ENGINE MAINTENANCE

The manual supplied with the VMT-1 engine (either gas or diesel) has a comprehensive maintenance schedule. Perform all engine maintenance according to the guidelines in the manufacturer's manual.

This chapter highlights some engine maintenance procedures, but does not describe all maintenance. Always follow the recommendations in the engine manual.

In This Chapter

ENGINE MAINTENANCE
DAILY MAINTENANCE
WEEKLY MAINTENANCE
MONTHLY MAINTENANCE
OIL CHANGE SCHEDULE
CLEANING THE WATER
STRAINER

DAILY MAINTENANCE

Perform the following maintenance each day:

- Clean the vacuum system filter (see “Cleaning the Vacuum Filter” below). Verify that the clamps are secured tightly.
- Lubricate the vacuum blower (see “Lubricating the Blower” below).
- Verify that all trailer and accessory lights are working.
- Check suction hoses for abrasions, holes, kinks, or damaged connectors. Replace if necessary.
- Clean any debris from the tank door seal.
- Verify that the latches on the tank door seal the door tightly. See “Adjusting the Tank Latches” in Chapter 7.

Cleaning the Vacuum Filter

The filter should be cleaned every day; more frequently when vacuuming dust or water that is very dirty. If the vacuum begins to lose suction, check the filter and clean it if necessary. Once the filter is cleaned, it must be allowed to dry before reinstallation.

Keep at least one spare filter on hand so that filters can be swapped for cleaning.

1. Shut off the vacuum switch at the control panel.



Figure 6-1. Turn the Vacuum/Pressure Washer switch to the OFF position.

2. Loosen the three wing nuts holding the latches on the filter canister cover.



Figure 6-2. Loosen the wing nuts on the three filter canister latches far enough to swing the latches back.

3. Swing the latches back and pull the cover down.



Figure 6-3. Open the canister door.

4. Unscrew and remove the knob holding the filter element in the canister. Remove the washer on the screw.



Figure 6-4. Remove the knob holding the filter in place. Be careful not to lose the washer behind the knob.

5. Pull the filter out of the canister. Remove the end cover.



NOTE

The blower can be lubricated through the filter canister while the filter is removed. See "Lubricating the Blower" below.

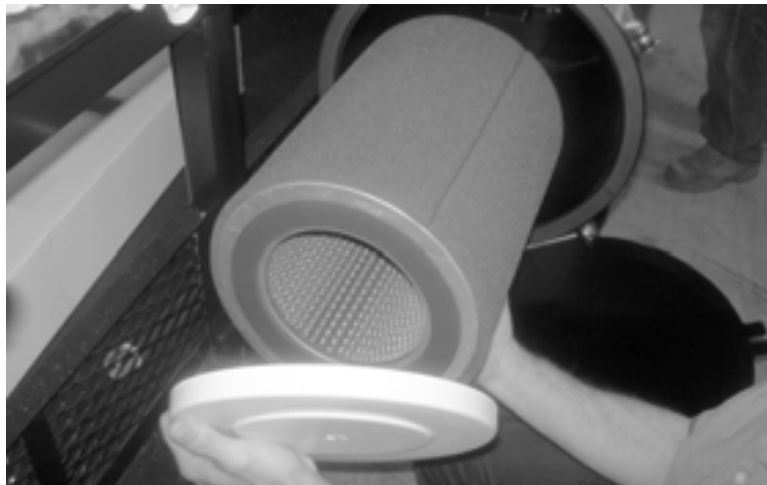

Figure 6-5. Remove the filter and take off the cover.

6. Remove the filter element from the holder and replace it with the spare filter.
7. Put the filter holder back into the canister.
8. Replace the cover over the end of the filter. Install the washer and the locking knob, securing the knob tightly.

9. Close the canister door and fasten it with the three swing latches.
10. Wash the filter that was removed in clean water, or a water/detergent solution. Rinse the filter and set it where it can dry.

Lubricating the Blower

To prevent corrosion, lubricate the blower at the end of the day with a spray lubricant such as WD-40. Apply the spray through the port underneath the blower. Access the port through the accessory storage box under the trailer.



Figure 6-6. Access the blower lubrication port through the accessory storage box.

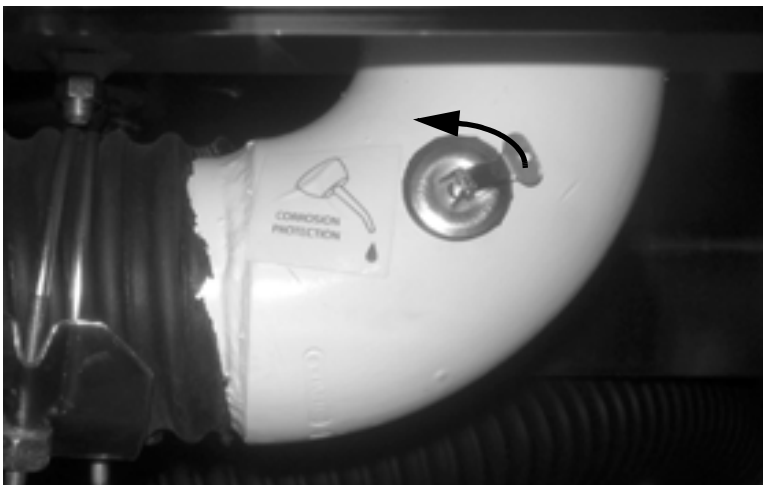

Figure 6-7. Flip the tab up to remove the plug for lubricating the blower.



IMPORTANT

Do not spray the filter element with pressurized water. High-pressure spray may tear the filter.



IMPORTANT

Run the vacuum blower when lubricating it to make sure the lubricant reaches all blower components.

Alternatively, it may be easier to spray into the blower when the filter is out of the canister for cleaning. Spray through the air port in the back of the canister.

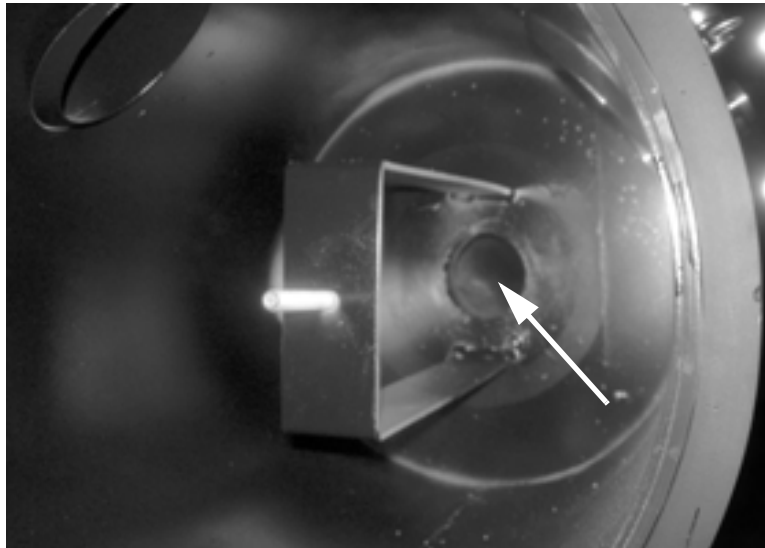

Figure 6-8. To lubricate the blower through the filter canister, spray through the port in the back.

1. When using the lubrication port beneath the blower, remove the plug.
2. When using the air port in the filter canister, remove the filter.
3. Start the engine and run it at medium throttle.
4. At the control panel, turn the Vacuum/Pressure Washer switch to the VAC position. The vacuum blower will engage.



Figure 6-9. Turn the Vacuum/Pressure Washer switch to the VAC position.

5. Spray lubricant into the blower for 15-30 seconds while the blower is running.
6. At the control panel, turn the Vacuum/Pressure Washer switch to the OFF position.



Figure 6-10. Turn the Vacuum/Pressure Washer switch OFF to turn off the vacuum.

7. If the lubrication port was used, replace the plug in the port. Flip the tab down to lock the plug in place.

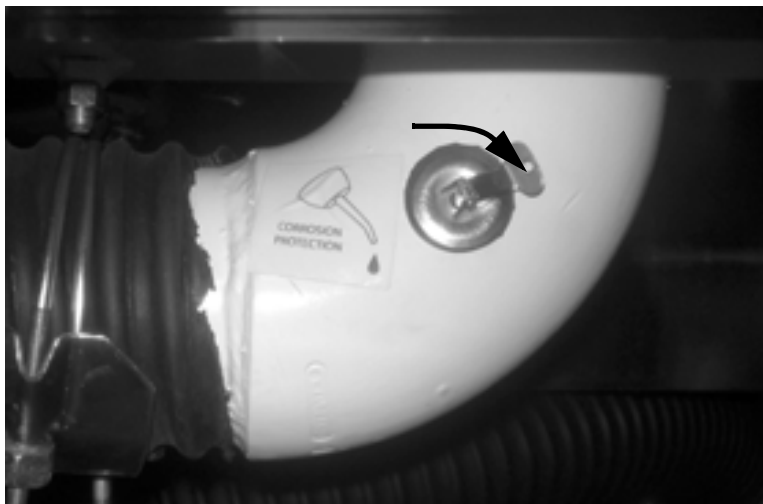

Figure 6-11. Flip the tab down to lock the plug.

WEEKLY MAINTENANCE

Perform the following maintenance procedures at least once per week.

- Clean any debris build-up from the spoils tank.
- Check lug nuts and fasteners for tightness, and tighten any that are loose.
- Check the oil level in the blower motor. Turn the blower off and wait five minutes to check the oil level.

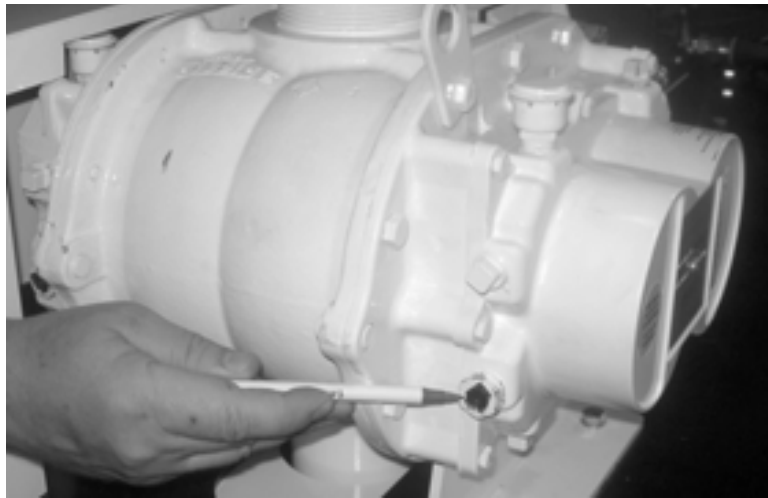

Figure 6-12. Check the blower oil level using the sight glass on the side of the blower. Oil should be visible in the glass.

- Check the sprayer pump oil level.

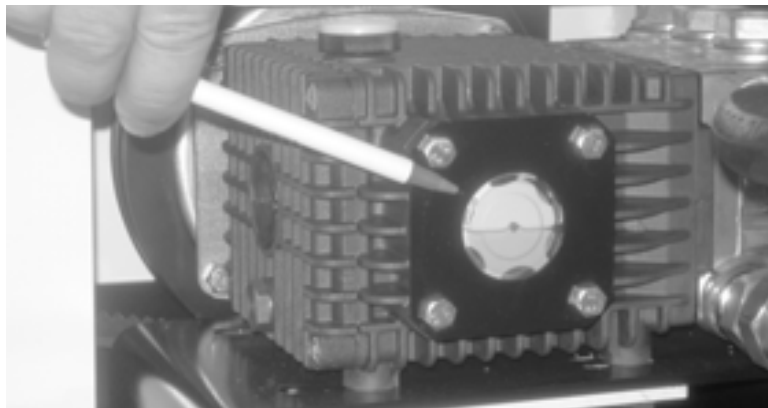

Figure 6-13. Check the sprayer pump oil level using the sight glass on the side of the pump. The oil level should be at about the middle of the sight glass.

- Check the engine oil level.

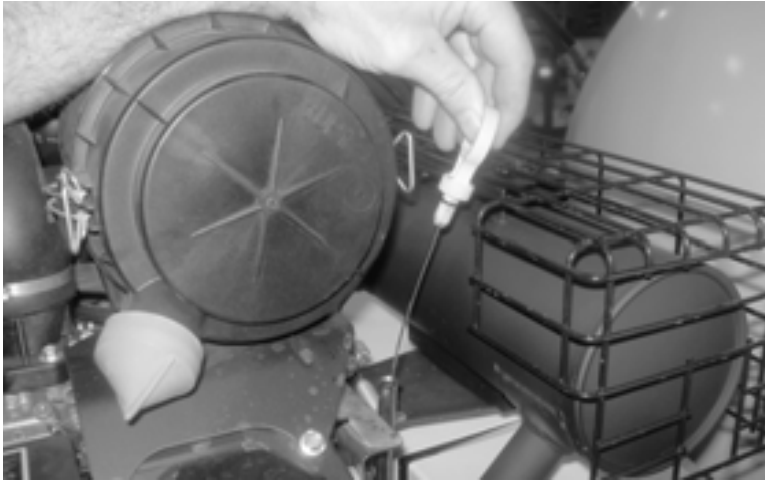

Figure 6-14. Check the engine oil level using the dipstick (gas engine shown).

- Spray lubricant (WD-40 or equivalent) into the pressure relief valves on the filter canister. Push the valves in several times while spraying to fully lubricate them.



Figure 6-15. Spray lubricant on the pressure relief valves.

MONTHLY MAINTENANCE

Check the following:

- Blower and sprayer drive belts for proper tension and wear. (See “Servicing the Drive Belts” in Chapter 7 for instructions on accessing, adjusting, and removing the belts.)
- All piping and fittings for loose connections, tighten if necessary.
- Tire pressure.
- Engine air filter. The gas engine has two filter elements, as shown below. Replace clogged or dirty filter elements.

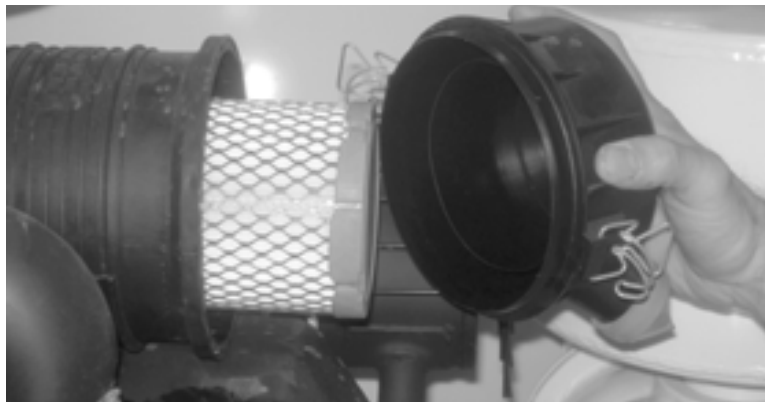

Figure 6-16. Remove the filter canister cap to access the engine air filter.



Figure 6-17. The filter has two elements. Check both and replace if dirty or clogged.

OIL CHANGE SCHEDULE

Engine

Gas engine—Change the oil every 100 hours of operation. Change the oil filter every 200 hours of operation.

Diesel engine—Change the oil and oil filter every 150 hours of operation.

Refer to the engine manufacturer's manual for maintenance schedules, instructions, and recommended oils.

The gas engine is fitted with an oil drain valve, and a drain hose is supplied to drain the oil. Attach the hose to the drain valve, and press and turn the valve to open it. Close the valve when the oil is finished draining.

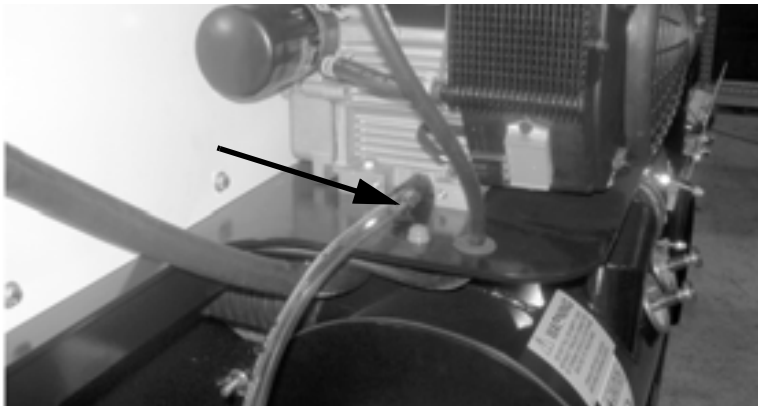

Figure 6-18. Attach the hose to the drain valve on the gas engine. Press the valve in and turn to open it.

Sprayer Pump

Change the oil in the sprayer pump after the first 50 hours of operation, then every 3 months or 500 hours of operation.

Change the oil after the pump has been running and is warm; turn the pump off for five minutes before removing the plug.

1. Remove the oil plug on the side of the sprayer pump to drain the oil.

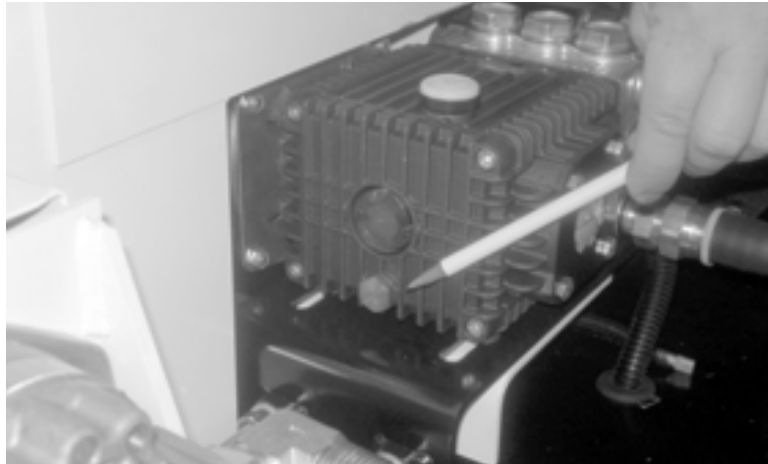

Figure 6-19. Remove the oil plug to drain the sprayer pump oil. Use a grease rag or shallow tray to catch the oil.

2. Replace and tighten the plug.
3. Remove the oil cap on top of the pump. Add oil until it reaches a level about halfway up on the sight glass. The sprayer pump holds 14 oz. (414 ml) of oil.



IMPORTANT

The recommended oil is General Pump Industrial Pump Oil Series 100, or a 30 weight non-detergent oil.



Figure 6-20. Remove the oil cap on the sprayer pump and fill the pump with oil. The cap has a dipstick.

Blower

Change the oil in the blower every 1,000 hours of operation.

1. Remove one of the drain plugs at the bottom of the blower housing to drain the oil.

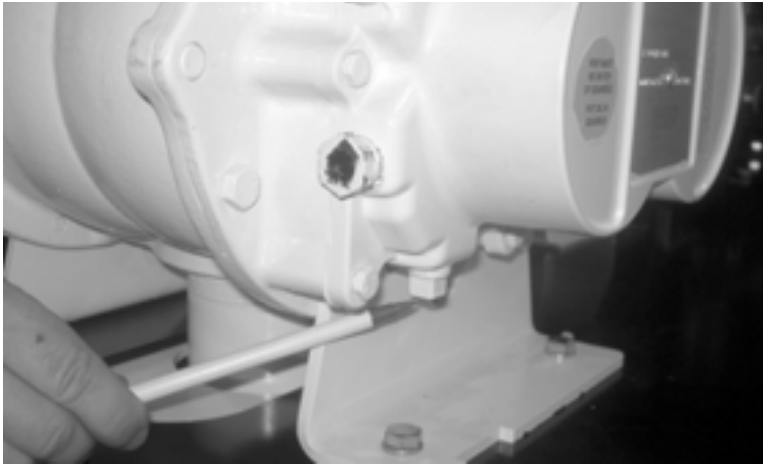

Figure 6-21. Remove the drain plug at the bottom of the blower to drain the oil.

2. When the oil has finished draining, replace the drain plug and tighten it.
3. Remove the oil fill cap on top of the blower housing.

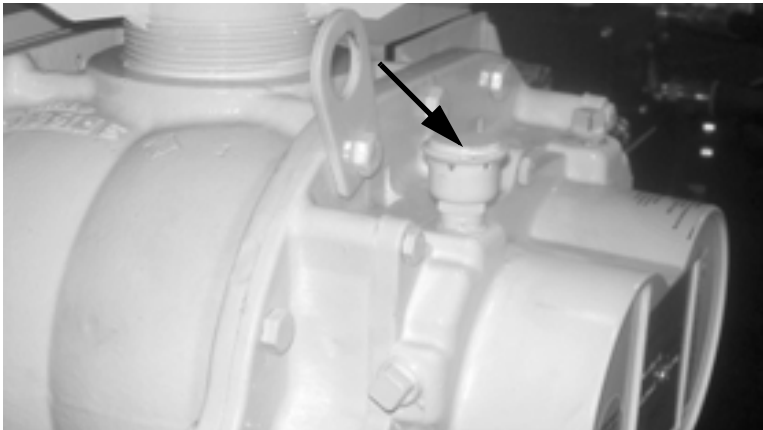

Figure 6-22. Remove the oil fill cap on the top of the blower housing.

4. Add oil until it is visible in the sight glass on the side of the blower. The blower holds 22.8 oz (670 ml) oil.
5. Replace the oil fill cap. Wipe any spilled oil off of the blower housing.

**IMPORTANT**

Change the blower oil after the initial 100 hours of operation.

**IMPORTANT**

Recommended oils are ROOTS synthetic oil 813-106- of the correct viscosity for the operating temperature (see Table 2 in the ROOTS blower manual), or a good grade of industrial non-detergent, rust inhibiting, anti-foaming oil.



NOTE

Trailers built *before* September 2008 have a strainer in the water line. Trailers built *after* September 2008 have a strainer in the fresh water tank. You will not need to perform this step if there is no strainer in the water line.

CLEANING THE WATER STRAINER

Trailers built before September 2008 have a water strainer installed in the water line. Visually check the strainer for debris and clean it when necessary.

1. Unscrew the water strainer bowl from the fitting.



Figure 6-23. Unscrew the strainer bowl.

2. Remove the screen from the bowl and rinse or spray it gently to remove debris.

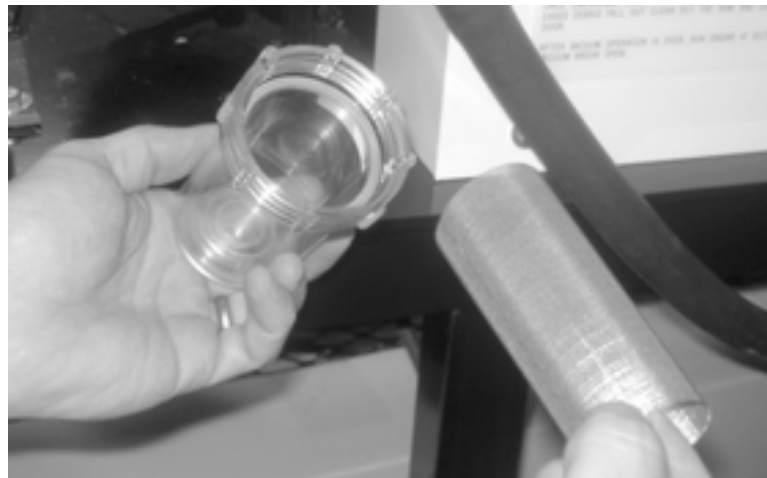

Figure 6-24. Remove the screen and clean it.

3. Replace the screen in the bowl and screw the bowl back onto the water line fitting.

Chapter 7

Service and Repair

CHANGING A TIRE

1. Park the trailer on a level spot, and leave it attached to the vehicle.
2. Release the cable mount holding the spare tire and lower the tire to the ground.

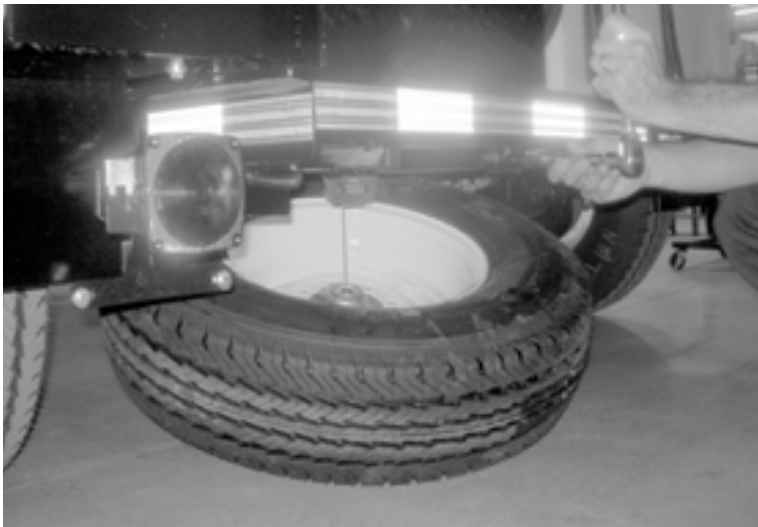

Figure 7-1. Turn the nut on the cable mount to lower the spare tire.

3. Remove the spare tire from the cable mount.

In This Chapter

CHANGING A TIRE

REPLACING TANK SHUT-OFF SEAL

REPLACING CONTROL PANEL SWITCHES

REPLACING FUSES

SERVICING THE DRIVE BELTS

ADJUSTING THE TANK LATCHES

REPLACING THE BATTERY

JUMP-STARTING THE ENGINE

REPLACING LIGHT BAR BULBS

4. Use a screwdriver to remove the wheel cover.



Figure 7-2. Use a standard screwdriver in the wheel cover slot to remove the cover.

5. Use a 3/4" wrench or socket to loosen the lug nuts.
6. Use a hydraulic or floor jack under the axle to raise the side of the trailer with the damaged/worn tire.
7. Remove the lug nuts and take off the tire.



Figure 7-3. Remove the lug nuts.

8. Put the spare tire on the wheel. Replace and snug the lug nuts.
9. Lower the jack and remove it.
10. Tighten the lug nuts securely. Replace the wheel cover, push until it snaps into place.

11. Mount the removed tire on the cable mount at the back of the trailer. Turn the cable nut to lift the tire securely against the bottom of the trailer.

REPLACING TANK SHUT-OFF SEAL

The spoils tank has a shut-off valve in the top. A buoyant ball plugs the port when the tank is filled with liquid. If the rubber seal in the valve is damaged or worn, the ball will not seal tightly.

There are two styles of tank cap, as shown in Figure 7-4.



Figure 7-4. The older style of tank cap (left) has a knurled knob; the newer style (right) uses wing nuts.



Figure 7-5. Remove the knurled knob from the tank cap, then pull the cap off. It may be necessary to tap the side of the cap with a rubber hammer to break the seal.



Figure 7-6. The seal is in the vacuum port. Pry the old seal out and press the new seal in.

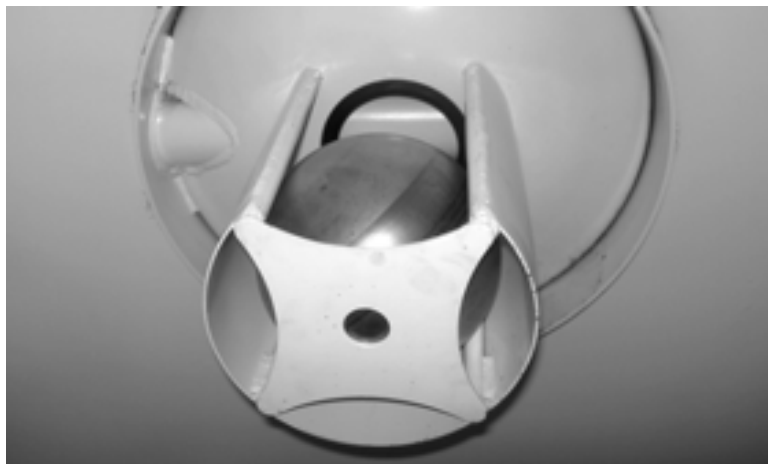

Figure 7-7. Check the seal from the inside of the tank to ensure that it is properly seated.



NOTE

Switches are identified in drawing number D 77-ELEC-A in Chapter 8. Refer to the drawing to order replacement switches.

REPLACING CONTROL PANEL SWITCHES

Replace damaged switches by taking off the control panel and removing the switches from the back.

1. Turn off power at the engine keyswitch.

- Remove the four screws holding the control panel to the trailer.

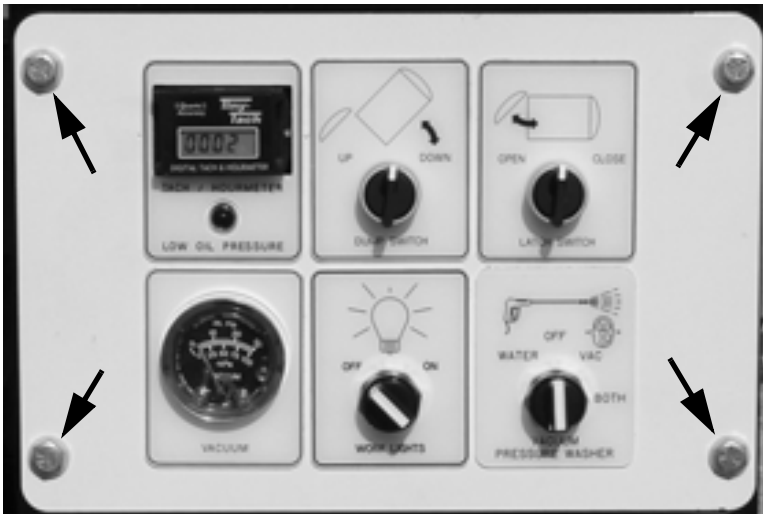

Figure 7-8. Remove the four screws at the corners to take off the control panel.

- Carefully tip the control panel down, being sure not to pull off any wires.

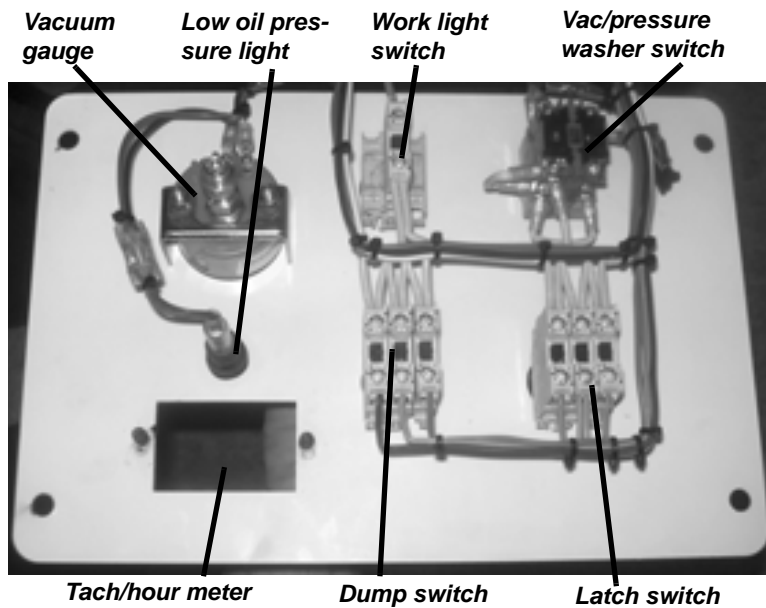

Figure 7-9. Components as shown on the back of the control panel.

4. To remove a switch or gauge, first disconnect the wires. Use a screwdriver if necessary to loosen the junction screws.
5. The tach/hour meter is fastened to the panel with screws. Remove the screws to replace it.

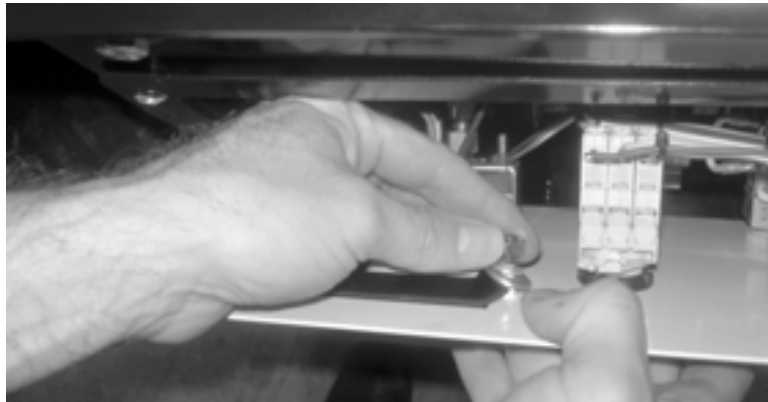

Figure 7-10. Remove the nuts and screws to take off the tach/hour meter.

6. The vacuum gauge is held to its bracket by two screws. To replace the vacuum gauge first remove the hose, then the screws.

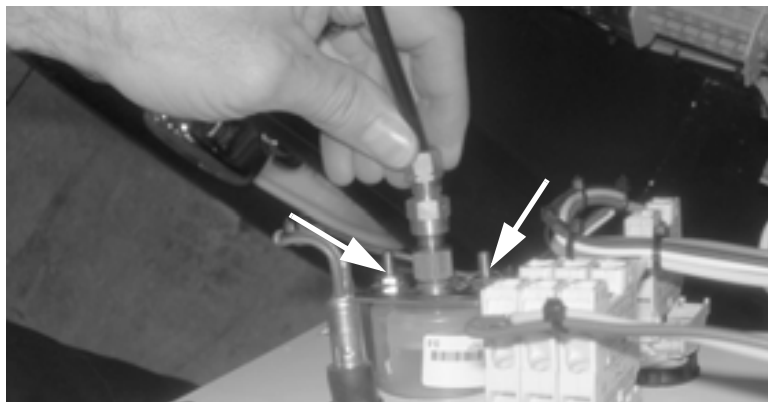

Figure 7-11. Remove the hose from the vacuum gauge, then take out the screws holding it to the bracket.

7. The switches are fastened together with a locking ring. Squeeze the ring and turn it to remove the back of the switch.



Figure 7-12. The locking ring shown holds the body of the switch to the front section.

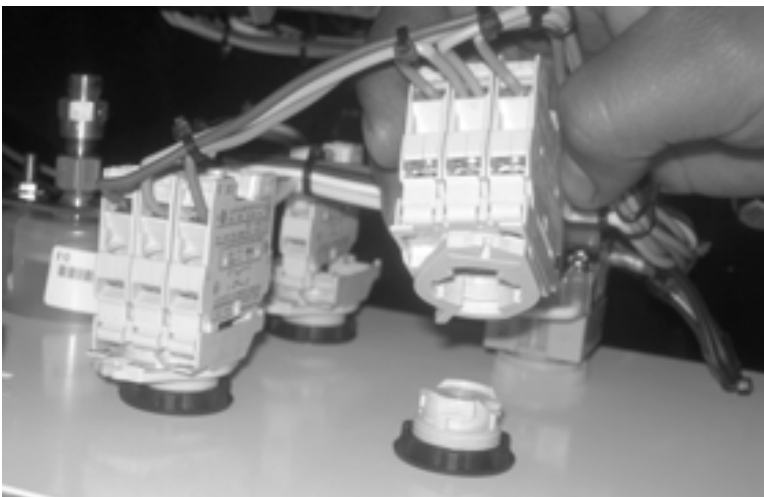

Figure 7-13. Turn the locking ring to disassemble the switch for removal.

8. To remove the front of the switch, unscrew the locking collar securing it to the control panel, then pull the switch out through the front of the panel.



Figure 7-14. Remove the locking ring to take the front of the switch out of the control panel.

9. After replacing the control panel components, re-attach the panel to the trailer with the four screws.

REPLACING FUSES

The fuse panel is behind the serial tag plate below the control panel.

1. To access the fuse box, remove the four screws holding the serial tag plate.

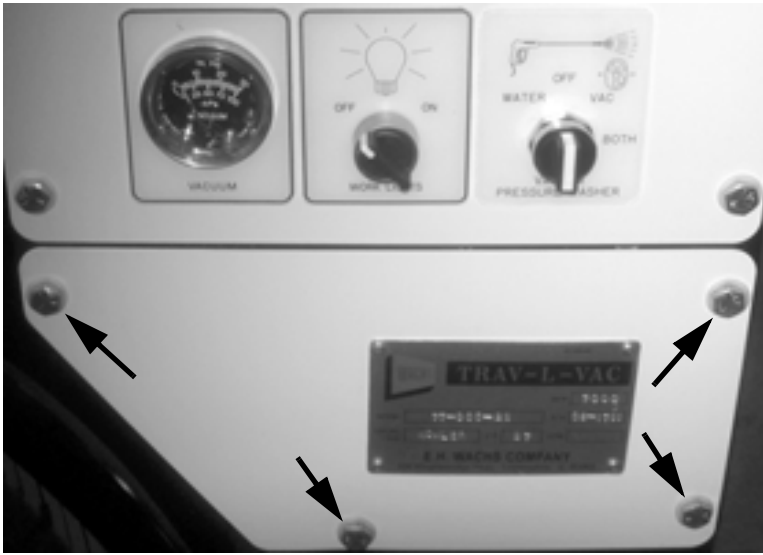

Figure 7-15. Remove the four screws on the serial tag plate.

2. Identify the blown fuse in the fuse block. Pull out the blown fuse and press in a new fuse. Ensure that the new fuse is the correct amperage rating; see the electrical drawing in Chapter 8.

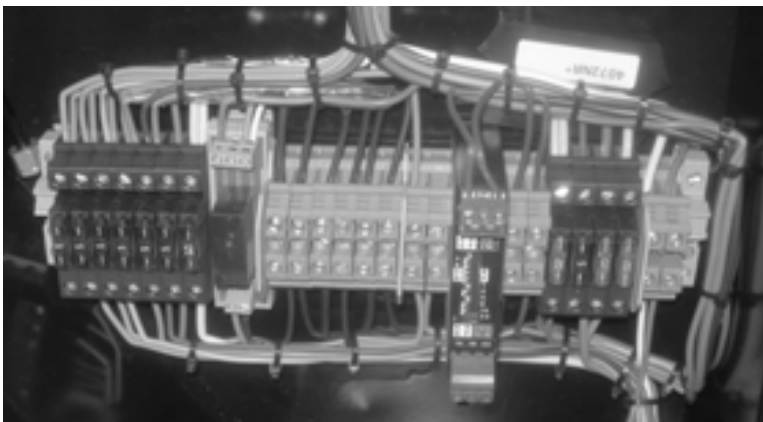

Figure 7-16. Identify the blown fuse in the fuse block.

3. Replace the serial tag plate; fasten it with the screws.



NOTE

Fuses are identified in drawing number D 77-ELEC-A in Chapter 8. Refer to the drawing to order replacement fuses.

SERVICING THE DRIVE BELTS

This section describes how to check and replace the drive belts (two each) for the sprayer pump and vacuum blower in addition to procedures for tightening the belts.

Belts that are in good condition may be tightened rather than replaced. Check for cracks, tears, worn surfaces, or signs of overheating when inspecting the belts. Replace any belt that is damaged.

Vacuum Blower Belts

1. Remove the screw holding the back of the blower belt cover.



NOTE

Move the spoils tank out to the dump position for easier access to the belts.



Figure 7-17. Remove the screw on the back of the blower belt cover.

2. Remove the two top screws holding the priming tank bracket.



Figure 7-18. Remove the two top screws holding the priming tank bracket in place; then remove the bracket and tank.

3. Remove the bracket and priming tank.
4. Remove the two bottom screws on the front of the blower belt cover.



Figure 7-19. After removing the priming tank, remove the two bottom screws in the belt cover.

5. Inspect the belts for any damage. Check the tension on the belts.

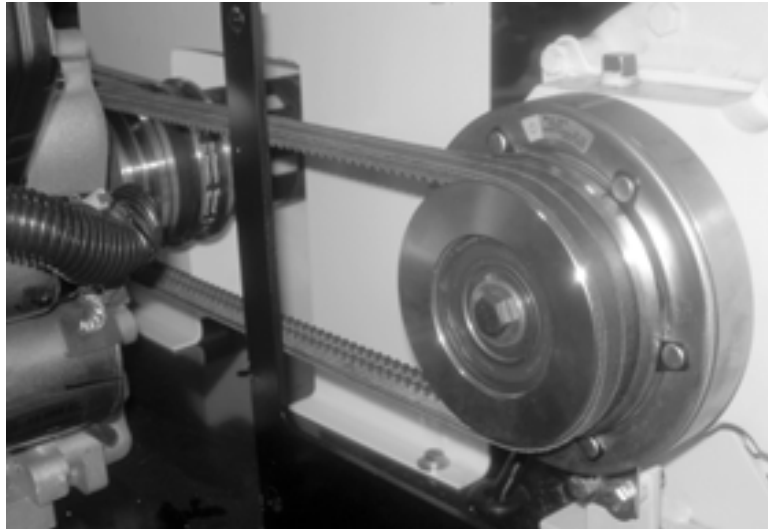

Figure 7-20. Inspect the blower belts for damage and correct tension.

6. To replace one or both belts, loosen the tension completely by turning the tension screws counter-clockwise. The tension screws for the blower are accessible through the accessory storage box.

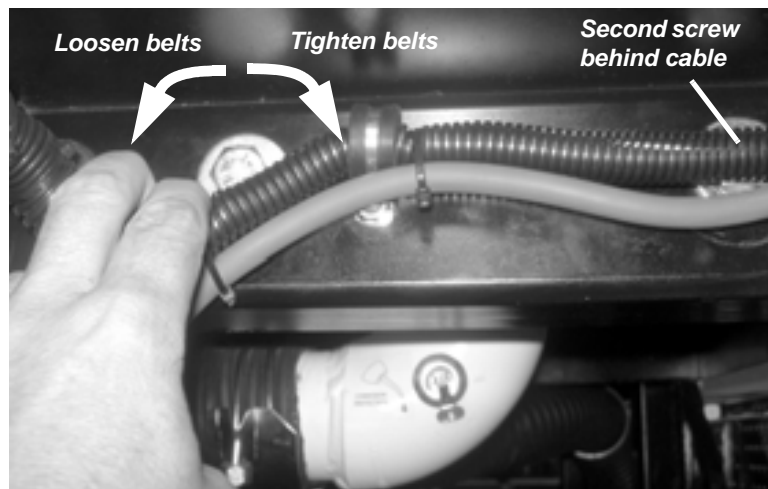

Figure 7-21. Access the blower belt tensioning screws through the accessory storage box in the back of the trailer. Pull the cables down to reach the screws with a wrench or socket.

7. Slip the worn or damaged belt off the pulleys, and replace it with the new belt.
8. Tighten the blower belt tensioning screws until the belts are tight on the pulleys. To check the tension, place your thumb on the belt halfway between the pulleys and press down. The belts should deflect no more than 1/2" (13 mm).
9. Replace the blower belt cover and insert the bottom two screws in the front.
10. Replace the priming tank and bracket and insert the top two screws holding the bracket.
11. Replace the screw in the back of the blower belt cover.

Sprayer Pump Belts

1. Remove the screw holding the back of the sprayer pump belt cover.



Figure 7-22. Remove the screw on the back of the sprayer pump belt cover.



NOTE

Turn both tensioning screws the same number of turns to keep the blower square with the drive system.



NOTE

Move the spoils tank out to the dump position for easier access to the belts.

2. Remove the four screws on the front of the cover.

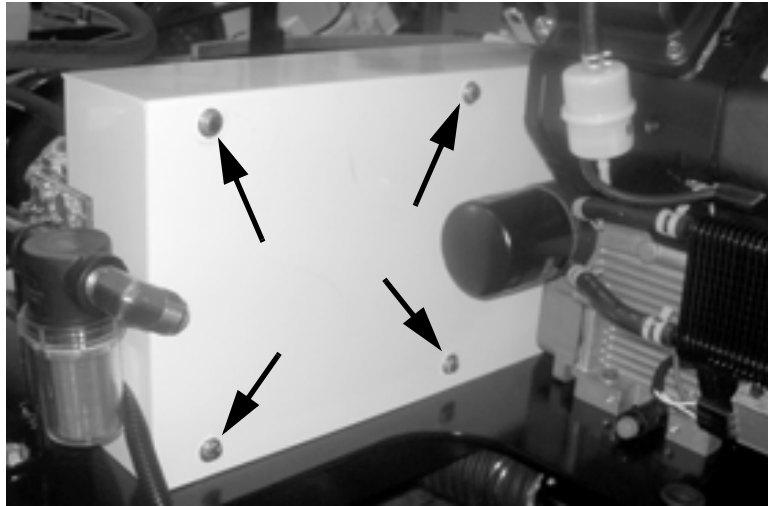

Figure 7-23. Remove the four screws holding the front of the sprayer pump belt cover.

3. Lift the cover up and tip it to remove it from behind the engine.
4. Inspect the belts for any damage. Check the tension on the belts.

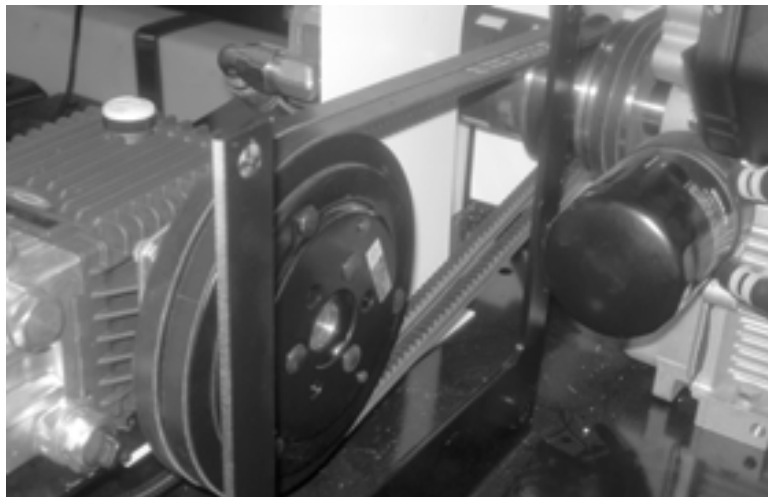

Figure 7-24. Inspect the sprayer pump belts for damage and correct tension.

5. To replace one or both belts, loosen the lock nuts on the tension screws, and then turn the screws counter-clockwise until the belts can slip off the pulleys

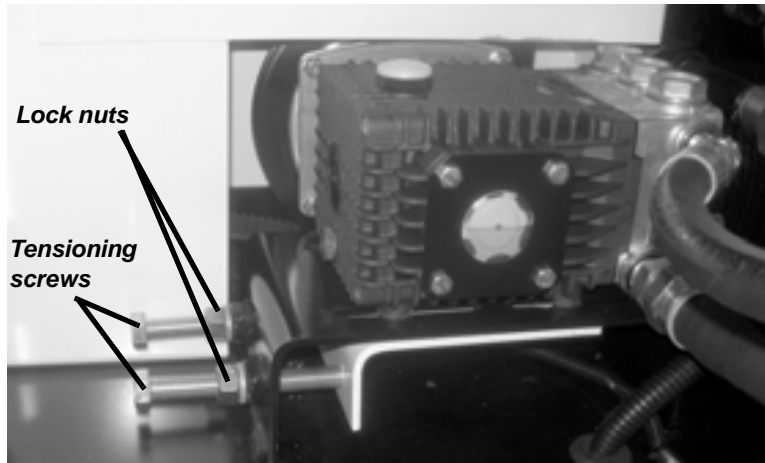

Figure 7-25. Loosen the lock nuts, then turn the tensioning screws counter-clockwise to loosen the tension on the belts.

6. Slip the worn or damaged belt off the pulleys, and replace it with a new belt.
7. Tighten the sprayer pump belt tensioning screws until the belts are tight on the pulleys. To check the tension, place your thumb on the belt halfway between the pulleys and press down. The belts should deflect no more than 1/2" (13 mm).
8. Re-tighten the lock nuts on both tensioning screws
9. Replace the sprayer pump belt cover and insert the four screws in the front.
10. Replace the screw in the back of the sprayer pump belt cover.



NOTE

Turn both tensioning screws the same number of turns to keep the sprayer pump square with the drive system.

ADJUSTING THE TANK LATCHES

The clearance between the spoils tank door and the seal can be adjusted. If the door is leaking, tighten the latch pin adjustment. If the latch does not engage completely, loosen the latch pin adjustment.

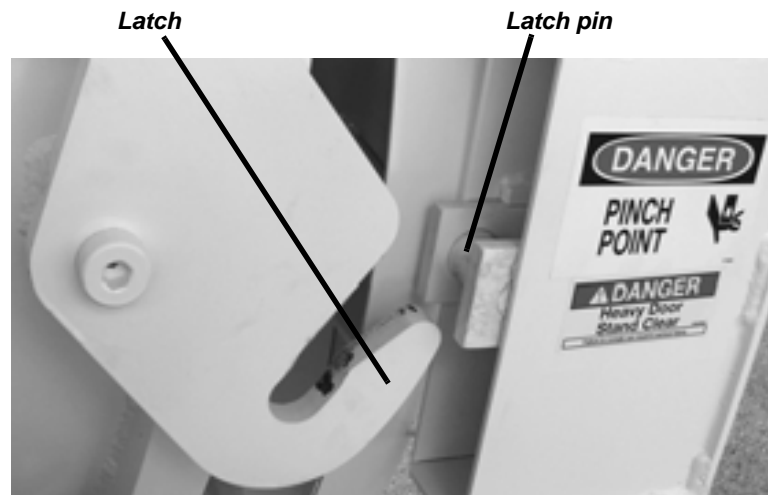

Figure 7-26. When closing the tank door, the latch engages behind the latch pin to clamp the door shut.

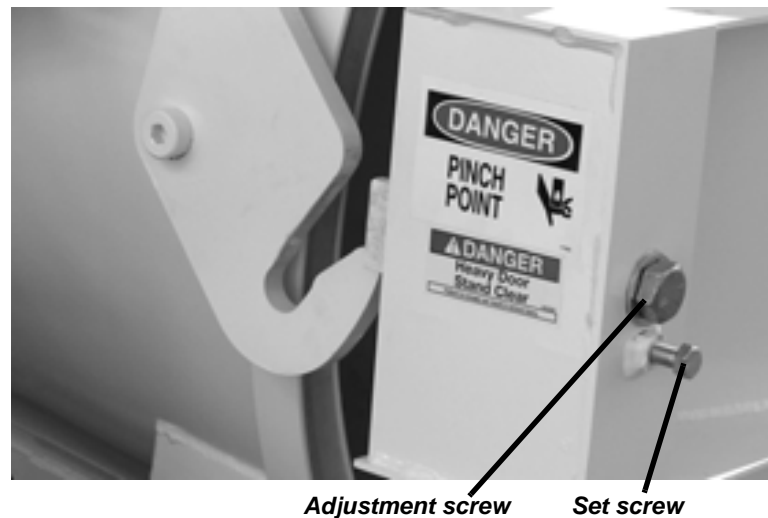

Figure 7-27. The front of the latch cover has screws for adjusting the latch.

Perform the following procedure on both sides of the tank door.

1. At the control panel, turn the Latch Switch to the OPEN position and hold it until the latch is fully released.



Figure 7-28. Turn the Latch Switch to the OPEN position and hold it until the latch fully opens.

2. Turn the set screw on the front of the latch cover several turns counter-clockwise to loosen it.



Figure 7-29. Turn the set screw counter-clockwise to loosen it.



NOTE

The power switch on the engine must be in the ON position to operate the door latch.



NOTE

Adjust the screw no more than one turn at a time. Operate the latch to check it after each turn.

3. To **tighten** the latch, turn the adjustment screw **clockwise**.



Figure 7-30. Turn the adjustment screw clockwise to tighten the latch.

4. To **loosen** the latch, turn the adjustment screw **counter-clockwise**.



Figure 7-31. Turn the adjustment screw counter-clockwise to loosen the latch.

5. Securely tighten the set screw when the adjustment is completed.

REPLACING THE BATTERY

Fully charge the new battery before installing it.

1. If necessary, jump-start the engine (see the following section) to operate the spoils tank dump mechanism.
2. At the control panel, turn and hold the Dump Switch to the UP position. Hold the switch until the tank is fully tipped up, then release it to the center position.



Figure 7-32. Turn the Dump Switch to the UP position and hold it until the tank is completely tipped.

3. Turn the engine off.
4. Remove the strap and take the cover off the box to access the battery. The battery box is behind the tank, toward the front of the trailer.



Figure 7-33. Remove the strap and take the cover off the battery box.

5. Disconnect the battery cables and remove the battery.
6. Put the new battery in the box, making sure it is in the same orientation as the old battery. Connect the cables.
7. Replace the cover and fasten the strap.



NOTE

If the battery seems good but won't charge, check the alternator on the engine to ensure that it is charging the battery.

JUMP-STARTING THE ENGINE

If the battery loses its charge or fails, the engine may be jump-started from any vehicle with a standard 12 volt electrical system. Replace a defective battery as soon as possible using the procedure in the previous section.

1. On the back of the engine, pull back the rubber boot covering the cable connection to the starter motor.

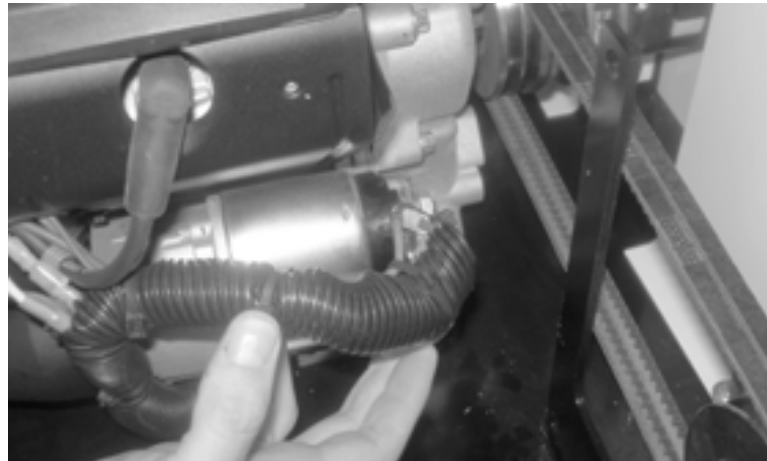

Figure 7-34. Pull back the boot on the starter motor power connector.



IMPORTANT

Ensure valve exercisers are turned off at each unit before jump-starting the engine. If valve exercisers are not turned off, damage to the electronic circuit board will result.

2. Connect the positive cable clamp to the exposed connector on the starter, as shown in Figure 7-35.
3. Connect the negative cable clamp to the swivel rail on the trailer bed.

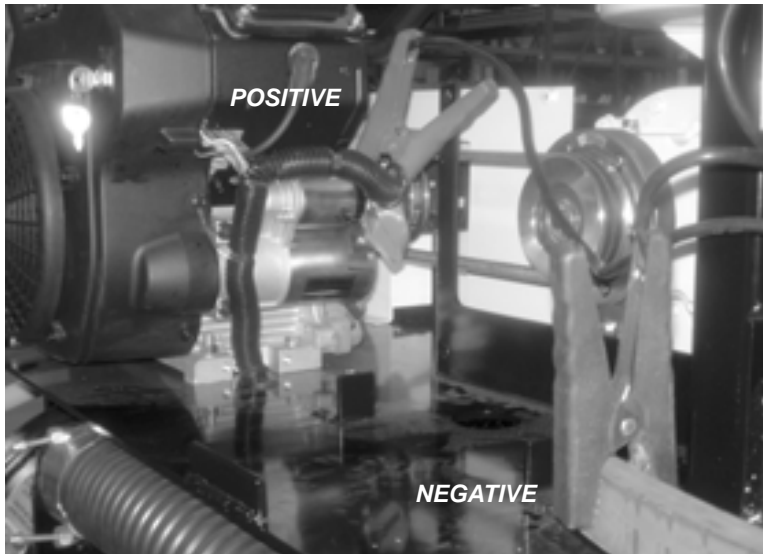

Figure 7-35. Connect the positive jumper cable clamp to the starter motor, and the negative clamp to the swivel rail.

4. Connect the other positive clamp to the positive post on the vehicle battery.
5. Connect the other negative clamp to the negative post on the vehicle battery.
6. Start the engine according to the instructions in Chapter 5.
7. Remove the jumper cable clamps from the VMT-1 engine and swivel rail, and from the vehicle battery.
8. Run the engine for at least several minutes before turning it off. If the battery fails to charge, replace it.



NOTE

The light bar uses ECCO model R3000BH 35 W halogen bulbs, available from most industrial lighting suppliers.

REPLACING LIGHT BAR BULBS

The light bar uses eight individual bulbs that are easy to replace.

Light Bar Flashers

1. Using a Phillips screwdriver, remove the screws holding the cover on the burned-out bulb. Pull the cover off.



Figure 7-36. Remove the two screws and pull the cover off the burned-out bulb.

2. Twist the bulb in the socket and pull it out.



Figure 7-37. Remove the light bulb from the socket.

3. Insert a new bulb and twist it into the socket.
4. Replace the cover. Do not overtighten the screws.

Work Lights

1. Remove the cover by pulling back the rubber seal around the lamp housing as shown in Figure 7-38.
2. Pull the bulb out of the rubber seal.



Figure 7-38. Pull the cover and bulb out of the rubber seal around the lamp housing.

3. Remove the wire leads from the bulb.
4. Connect the leads to the new bulb and press it back into the rubber seal.
5. Press the cover back into the seal, making sure it is firmly seated to prevent water seepage.



Chapter 8

Parts Lists and Drawings

.....

Refer to the following drawings and component lists to identify part numbers and perform service.

D 77-ELEC-A	Electrical schematic (pre-September 2007)
D 77-ELEC-B	Electrical schematic (post-September 2007)
D 77-HYD W-DA	Hydraulic schematic (pre-September 2007)
D 77-HYD W-DB	Hydraulic schematic (post-September 2007)
D 77SWIVEL-PWA	Pressure washer schematic (pre-September 2007)
D 77SWIVEL-PWC	Pressure washer schematic (post-September 2007)

This page intentionally left blank.

TO 12V BATTERY

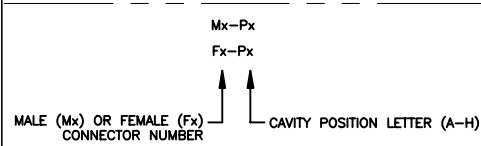
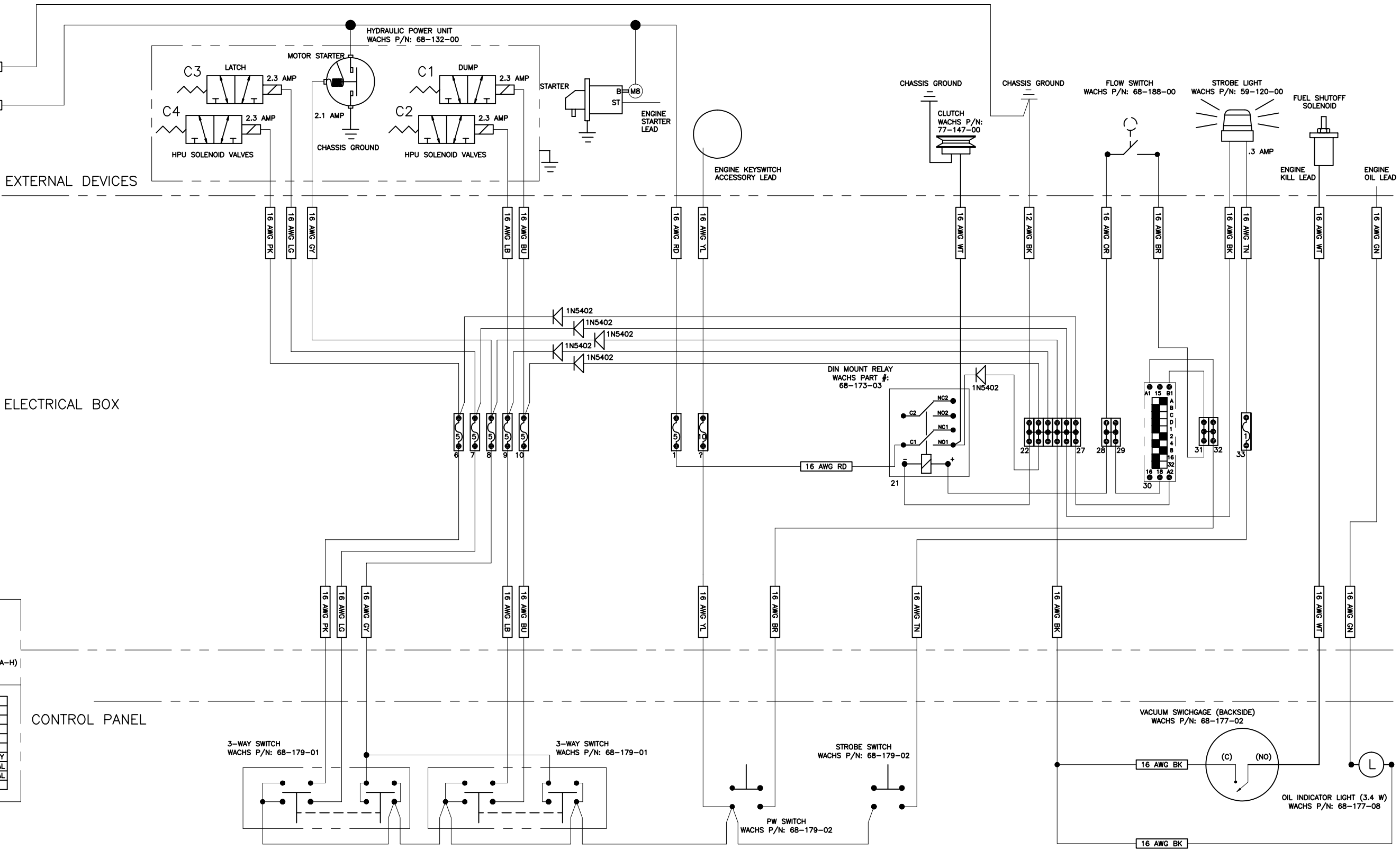
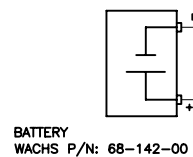

CONNECTOR ASSEMBLIES			
QTY.	MFG. P/N	WACHS P/N	DESCRIPTION
2	12066195	68-143-01	MALE CONNECTOR 8 CAVITY
3	12129498	68-143-02	14-12 AWG MALE TERMINAL
8	12020116	68-143-07	16-14 AWG MALE TERMINAL
2	12065141	68-143-03	MALE CAVITY LOCK
2	12064998	68-143-04	FEMALE CONNECTOR 8 CAVITY
3	12129494	68-143-05	14-12 AWG FEMALE TERMINAL
8	12066214	68-143-08	16-14 AWG FEMALE TERMINAL
4	12064999	68-143-06	FEMALE CAVITY LOCK

CONTROL PANEL

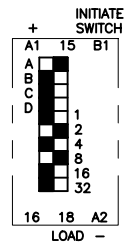

10 SECOND DELAY

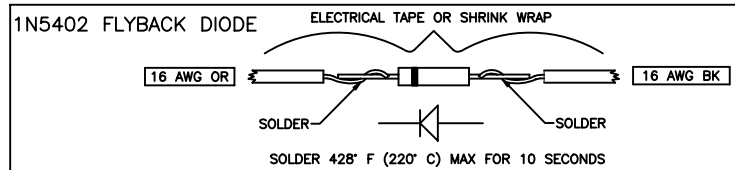

WIRING COLOR CODES	
BLACK	BK
WHITE	WT
RED	RD
BLUE	BU
ORANGE	OR
YELLOW	YL
BROWN	BR
PURPLE	PJ
GRAY	GY
PINK	PK
LIGHT BLUE	LB
TAN	TN
LIGHT GREEN	LG
GREEN	GN

NOTE: ALL UNNOTED WIRE IS 16 AWG

77-ELEC-A: PRE-09/07 PRODUCTION DATES
77-ELEC-B: POST-09/07 PRODUCTION DATES WITH CLUTCH EQUIPPED BLOWERS

TITLE: UTILITY VAC ELECTRICAL SCHEMATIC			
REV.	DATE	ECCO NO.	APR.
1	10/10/07	1000	DRM
DRN: MWG DATE: 5/13/03		MFTL:	
CHK: DATE:		FINSH:	
SCALE:			

DIMENSIONAL TOLERANCES:
 .XXX ±.005 ANGLES ±15 MIN.
 .XX ±.010 RUNOUT .003
 .X ±.015 FRACTIONS ±1/32
 UNLESS SPECIFIED

E.H.WACHS Co.
 WHEELING, IL

D 77-ELEC-A

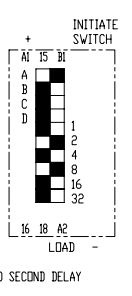
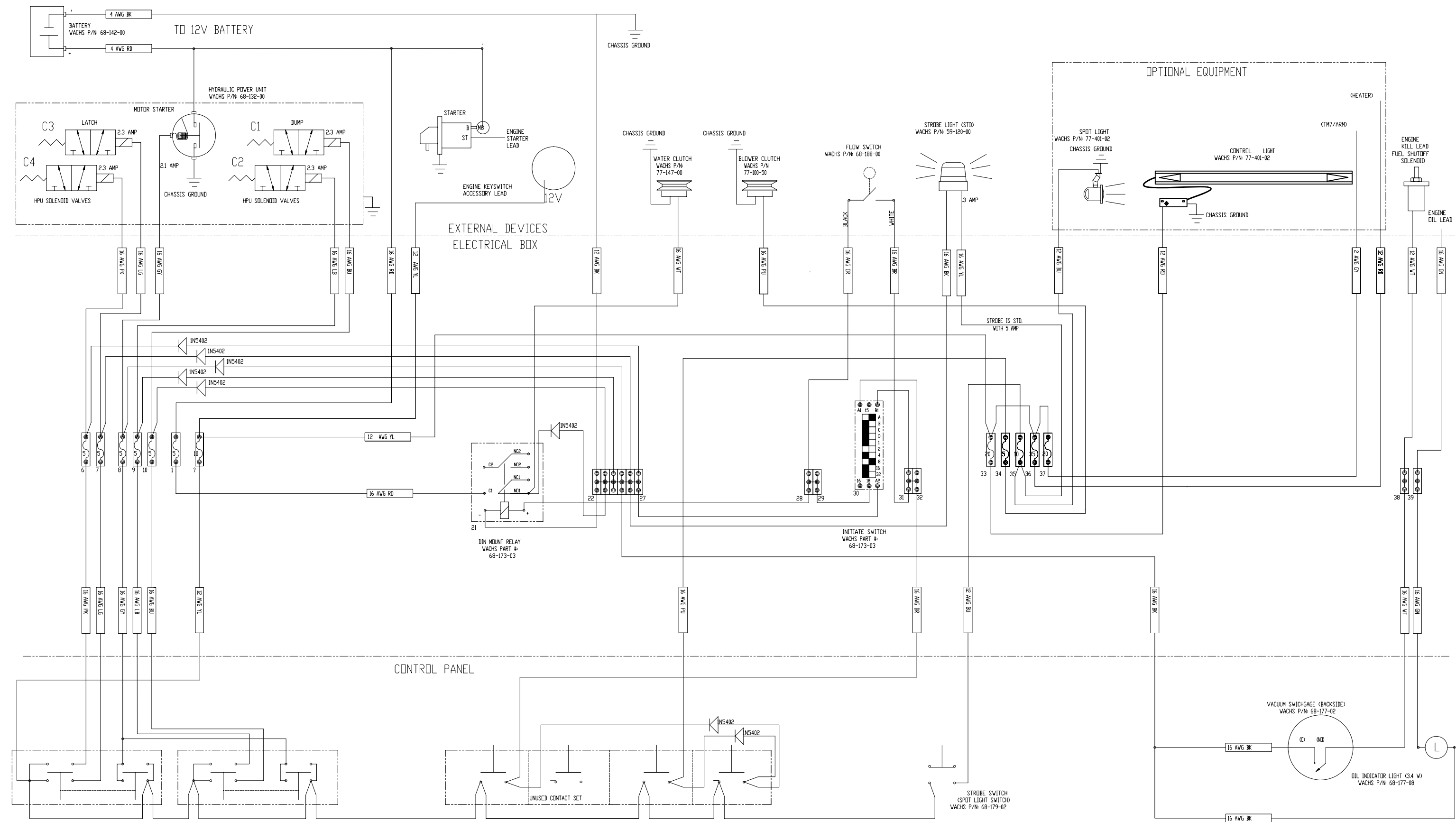

Connector assembly information:

MALE (Mx) OR FEMALE (Fx) CONNECTOR NUMBER

Mx-Px
Fx-Px

CAVITY POSITION LETTER (A-H)

QTY.	MFG. P/N	WACHS P/N	DESCRIPTION
2	12066195	68-143-01	MALE CONNECTOR 8 CAVITY
3	12129498	68-143-02	14-12 AWG MALE TERMINAL
8	12020116	68-143-07	16-14 AWG MALE TERMINAL
2	12065141	68-143-03	MALE CAVITY LOCK
2	12064998	68-143-04	FEMALE CONNECTOR 8 CAVITY
3	12129494	68-143-05	14-12 AWG FEMALE TERMINAL
8	12066214	68-143-08	16-14 AWG FEMALE TERMINAL
4	12064999	68-143-06	FEMALE CAVITY LOCK

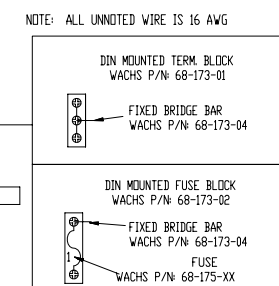
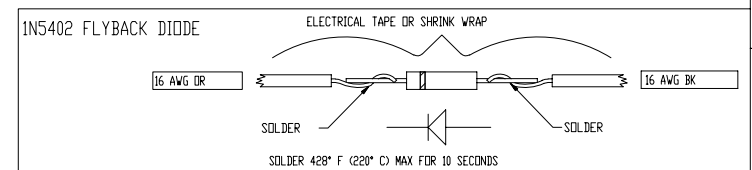

WIRING COLOR CODES

BLACK	BK
WHITE	WT
RED	RD
BLUE	BU
ORANGE	DR
YELLOW	YL
BROWN	BR
PURPLE	PU
GRAY	GY
PINK	PK
LIGHT BLUE	LB
TAN	TN
LIGHT GREEN	LG
GREEN	GN

77-ELEC-A: PRE-09/07 PRODUCTION DATES
77-ELEC-B: POST-09/07 PRODUCTION DATES WITH CLUTCH EQUIPPED BLOWER

UTILITY VAC ELECTRICAL SCHEMATIC

REV.	DATE	BY	CHK	APP.	TRD	DATE	BY	CHK	APP.
1	10/07	1024	SMW			10/10/07	WFL		

INSTRUCTIONS: TELETYPE UNIT, 24 HRS. SERVICE, 24 HRS. FUNCTIONAL SERVICE UNLESS SPECIFIED

E.H. WACHS Co. LINCOLNSHIRE, IL

D 77-ELEC-B

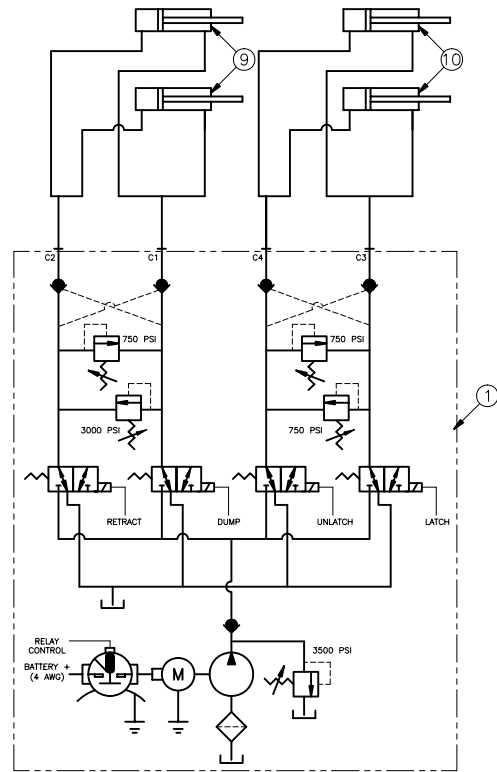

REF. No.	PART No.	QTY.	DESCRIPTION	INSTALLATION NOTES
1	68-132-00	1	HPU	FILL WITH DEXTRON AUTOMATIC TRANSMISSION FLUID
2	68-123-00	4	ADAPTER; -6 JIC x -6 ORB	-6 ORB TORQUE 34-36 FT.-LB.
3	77-140-00	2	HYD. HOSE ASSEMBLY (106" LONG)	-6 JIC TORQUE 20-22 FT.-LB.
4	68-121-01	4	NUT, -6 (9/16"-18 THREAD)	9/16"-18 NUT TORQUE 88 FT.-LB.; USE THRD. LOCK
5	77-123-00	4	BULKHEAD TEE FITTING; -6 JIC	-
6	77-078-00	2	HYD. HOSE ASSEMBLY (42" LONG)	-6 JIC TORQUE 20-22 FT.-LB.
7	77-079-00	2	HYD. HOSE ASSEMBLY (22" LONG)	-6 JIC TORQUE 20-22 FT.-LB.
8	77-122-00	4	ADAPTER; 90 DEG -6 JIC x -8 ORB	-8 ORB TORQUE 58-62 FT.-LB.
9	77-015-01	2	HYDRAULIC CYLINDER	2" BORE, 18" STROKE
10	68-103-00	2	HYDRAULIC CYLINDER	2" BORE, 4" STROKE
11	68-122-00	4	ADAPTER; -6 JIC x 3/8" MPT	3/8" NPT 2-3 T.F.F.T.; USE THREAD SEALANT
12	77-144-00	2	HYD. HOSE ASSEMBLY (??" LONG)	-6 JIC TORQUE 20-22 FT.-LB.
13	77-145-00	2	HYD. HOSE ASSEMBLY (??" LONG)	-6 JIC TORQUE 20-22 FT.-LB.

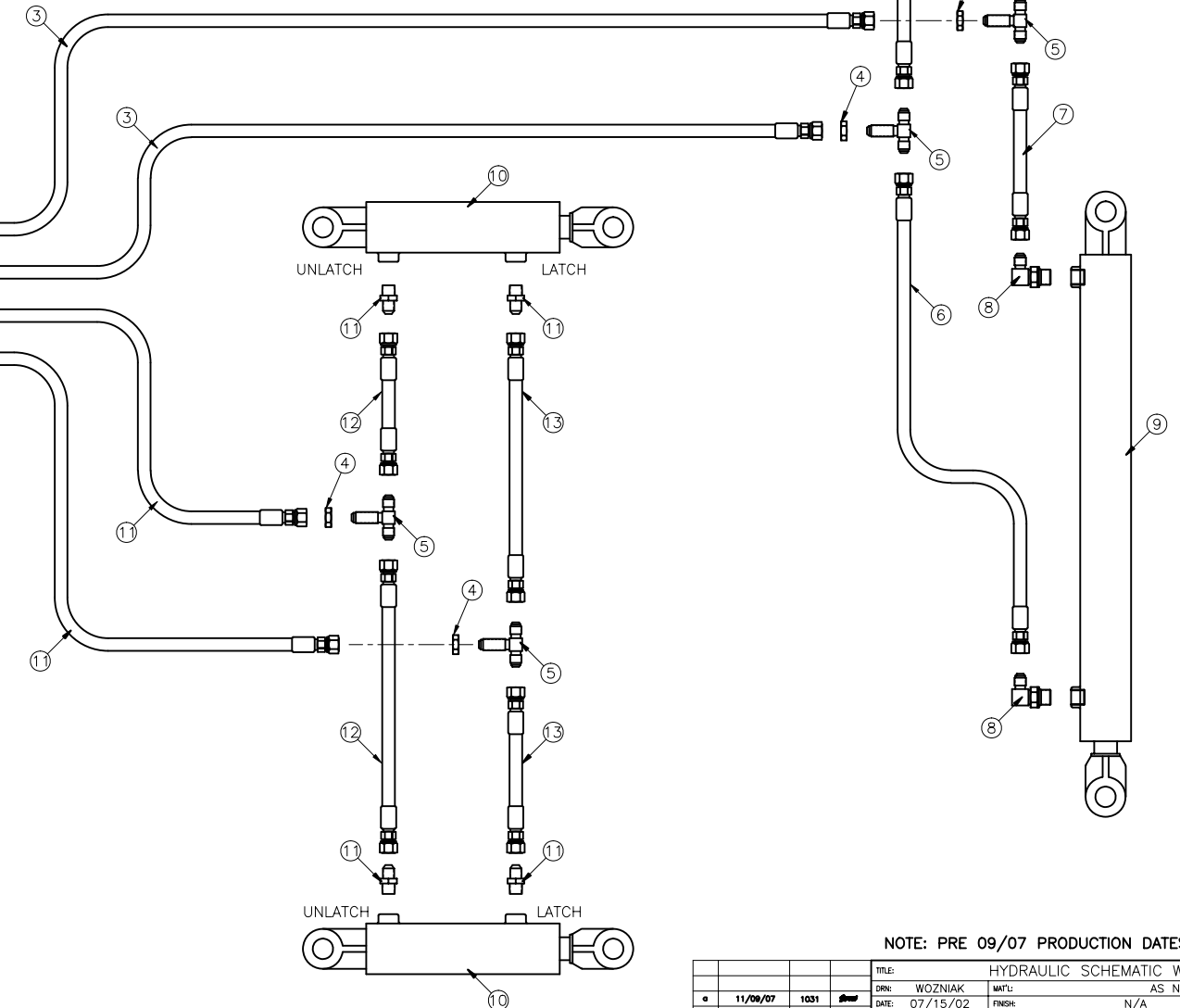
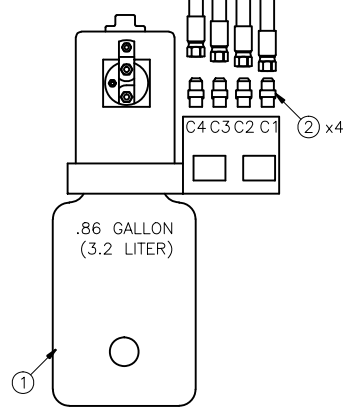
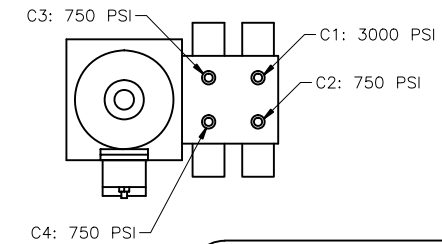

NOTE: PRE 09/07 PRODUCTION DATES

REV.		DATE	ECO NO.	APR.	TITLE	HYDRAULIC SCHEMATIC W/ DOOR
1	11/09/07	1031			DRN: WOZNAK	MATL: AS NOTED
					DATE: 07/15/02	FINSH: N/A
DIMENSIONAL TOLERANCES					SCALE: 1:4	
XXX ±.005 ANGLES ±15 MIN.					E.H.WACHS Co.	
XX ±.010 RUNOUT .003					WHEELING, IL	
X ±.015 FRACTIONS ±1/32					D77-HYD W-DA	
UNLESS SPECIFIED						

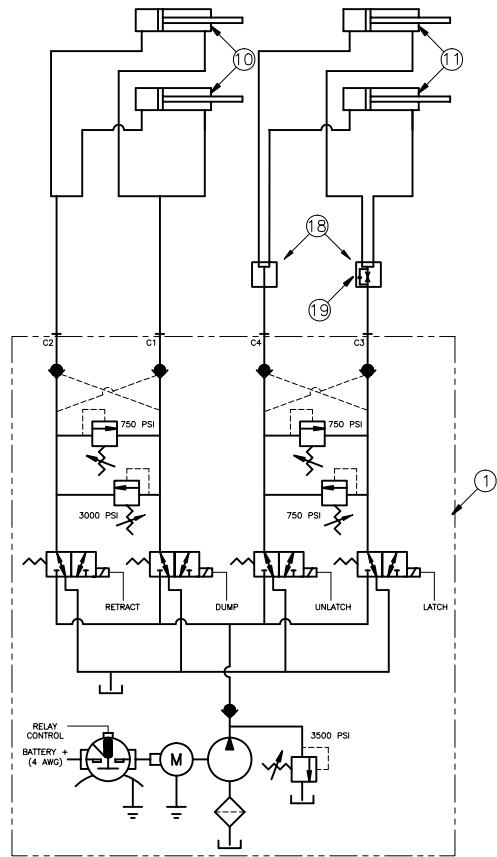

REF. No.	PART No.	QTY.	DESCRIPTION	INSTALLATION NOTES
1	68-132-00	1	HPU	FILL WITH DEXTRON AUTOMATIC TRANSMISSION FLUID
2	68-123-00	10	ADAPTER; -6 JIC x -6 ORB	-6 ORB TORQUE 34-36 FT.-LB.
3	77-140-01	1	HYD. HOSE ASSEMBLY (24 1/2" LONG)	-6 JIC TORQUE 20-22 FT.-LB.
4	77-140-02	1	HYD. HOSE ASSEMBLY (27 1/2" LONG)	-6 JIC TORQUE 20-22 FT.-LB.
5	68-121-01	2	NUT, -6 (9/16"-18 THREAD)	9/16"-18 NUT TORQUE 88 FT.-LB.; USE THRD. LOCK
6	77-123-00	2	BULKHEAD TEE FITTING; -6 JIC	-
7	77-079-01	2	HYD. HOSE ASSEMBLY (19 1/2" LONG)	-6 JIC TORQUE 20-22 FT.-LB.
8	77-078-01	2	HYD. HOSE ASSEMBLY (41 1/2" LONG)	-6 JIC TORQUE 20-22 FT.-LB.
9	77-122-00	8	ADAPTER; 90 DEG -6 JIC x -8 ORB	-8 ORB TORQUE 58-62 FT.-LB.
10	77-015-01	2	HYDRAULIC CYLINDER	2" BORE, 18" STROKE
11	68-103-00	2	HYDRAULIC CYLINDER	2" BORE, 4" STROKE
12	77-140-03	1	HYD. HOSE ASSEMBLY (13" LONG)	-6 JIC TORQUE 20-22 FT.-LB.
13	77-144-02	1	HYD. HOSE ASSEMBLY (97 1/2" LONG)	-6 JIC TORQUE 20-22 FT.-LB.
14	77-144-01	1	HYD. HOSE ASSEMBLY (131 1/2" LONG)	-6 JIC TORQUE 20-22 FT.-LB.
15	77-140-04	1	HYD. HOSE ASSEMBLY (12 1/2" LONG)	-6 JIC TORQUE 20-22 FT.-LB.
16	77-145-02	1	HYD. HOSE ASSEMBLY (99 1/2" LONG)	-6 JIC TORQUE 20-22 FT.-LB.
17	77-145-01	1	HYD. HOSE ASSEMBLY (124 1/2" LONG)	-6 JIC TORQUE 20-22 FT.-LB.
18	68-114-01	2	ALUMINIUM CARTRIDGE BODY	-8 ORB TORQUE 58-62 FT.-LB.
19	68-114-00	1	CARTRIDGE, FLOW DIVERTER	-10 ORB TORQUE 58-62 FT.-LB.
20	68-114-02	1	PLUG, CAVITY	-10 ORB TORQUE 58-62 FT.-LB.

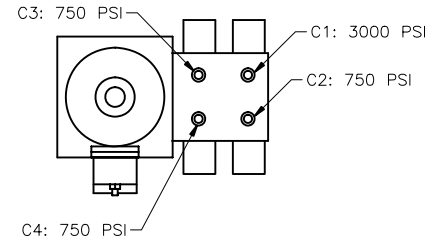
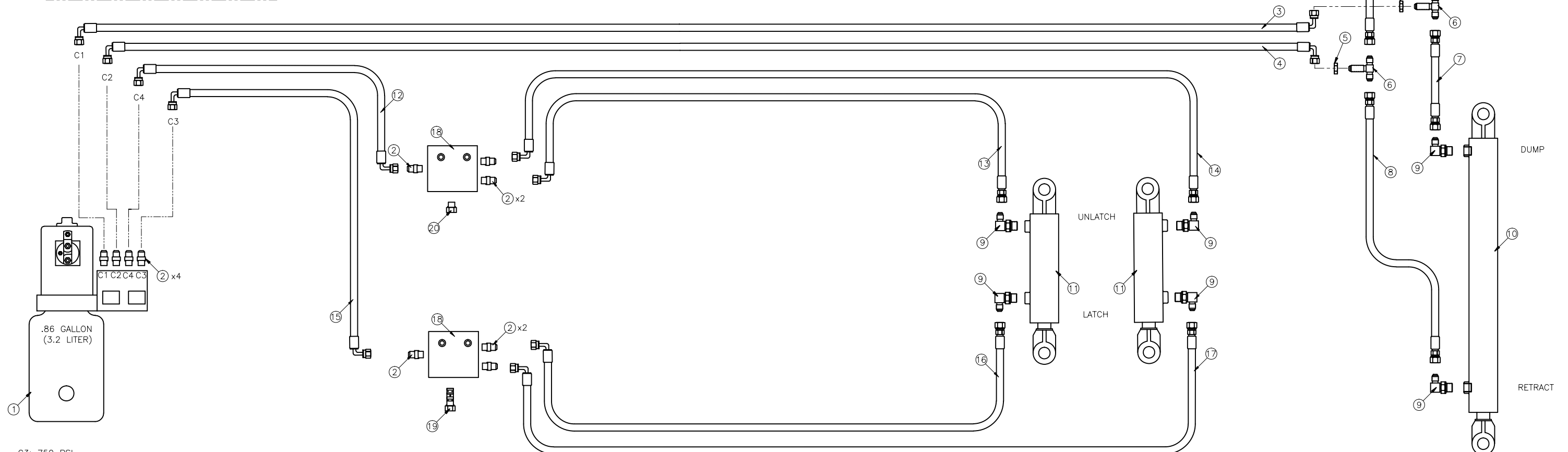

NOTE: POST 09/07 PRODUCTION DATES

REV. 0		DATE 10/08/07	ECO NO. 1030	APR.	TITLE: HYDRAULIC SCHEMATIC W/ DOOR	DRN: WOZNAK	MATL: AS NOTED	SCALE: 1:4
REV. 1		DATE 07/15/02	ECO NO.	APR.	DATE: 07/15/02	FINISH: N/A		
DIMENSIONAL TOLERANCES .XXX ±.005 ANGLES ±15 MIN. .XX ±.010 FINISH .003 .X ±.015 FRACTIONS ±1/32 UNLESS SPECIFIED				E.H. WACHS Co. WHEELING, IL		D77-HYD W-DB		

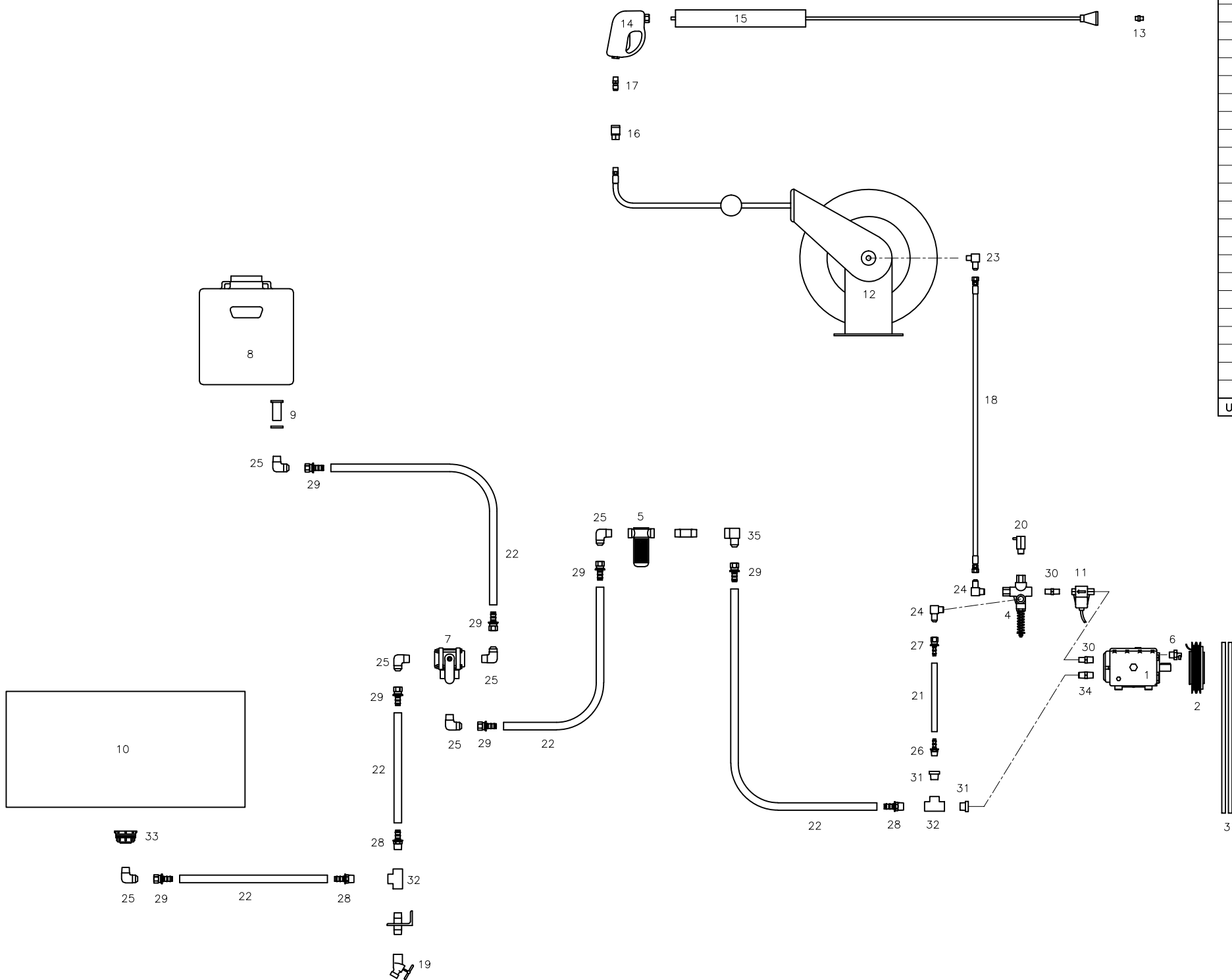

REF. No.	PART No.	QTY.	DESCRIPTION	INSTALLATION NOTES
1	77-085-00	1	PUMP, 2.6 GPM; 3000 PSI	FILL WITH 14.0 OZ NON-DETERGENT SAE 30 OIL
2	77-100-00	1	CLUTCH, 12 VDC	REFER TO DRAWING 02-081-101 FOR INSTRUCTIONS
3	77-127-00	2	BELT, AX41	V1505: NEW BELT STATIC TENSION 57.6/61.7 LB V2003T: NEW BELT STATIC TENSION 62.2/66.6 LB
4	68-137-00	1	UNLOADER VALVE	-
5	68-138-01	1	STRAINER	THREAD ONTO 3/4" NIPPLE IN POWERPACK
6	68-140-00	1	THERMAL VALVE	2-3 T.F.F.T.; OPENS AT 145° F
7	68-141-00	1	3-WAY VALVE	MOUNT TO POWER PACK BRACKET
8	68-146-00	1	ANTI-FREEZE TANK	DRILL Ø1/16" HOLE IN CAP
9	68-168-00	1	BULKHEAD FITTING, 1/2" NPT	DRILL HOLES IN ANTI-FREEZE TANK TO MOUNT
10	77-162-00	1	95 GALLON TANK	-
11	68-188-00	1	FLOW SWITCH	NOTE FLOW DIRECTION; WIRE TO ELECTRICAL BOX
12	68-195-00	1	HOSE REEL w/ 50' 3/8" HOSE	-
13	68-196-00	1	NOZZLE, .040 x 15'	-
14	68-199-00	1	SPRAY GUN	-
15	68-200-00	1	LANCE	-
16	68-201-00	1	3/8" FPT STAINLESS COUPLER	2-3 T.F.F.T.
17	68-202-00	1	3/8" MPT STAINLESS NIPPLE	2-3 T.F.F.T.
18	77-193-00	1	HOSE ASSEMBLY (50" LONG)	-8 JIC TORQUE 34-38 FT.-LB.
19	68-242-00	1	DRAIN COCK	THREAD ONTO 3/4" PIPE ON TRAILER
20	68-193-00	1	SAFETY RELIEF VALVE	SET VALVE AT 4200 PSI
21	68-184-02	18"	1/2" LOW PRESSURE PUSH ON HOSE	-
22	68-233-00	164"	3/4" LOW PRESSURE PUSH ON HOSE	-
23	90-078-59	1	ADAPTER, -8 MJ x -6 MPT 90°	-6 MP 2-3 T.F.F.T.; -8 JIC TORQUE 34-38 FT.-LB.
24	68-182-03	2	ADAPTER, -8 MJ x -8 MPT 90°	-8 MP 2-3 T.F.F.T.; -8 JIC TORQUE 34-38 FT.-LB.
25	90-128-75	6	ADAPTER, -12 MJ x -12 MPT 90°	-12 MP 2-3 T.F.F.T.; -12 JIC TORQUE 78 FT.-LB.
26	68-185-00	1	COUPLING, 1/2" HOSE x 1/2" MPT	-
27	68-183-00	1	COUPLING, 1/2" HOSE x 3/4-16 F JIC	-
28	68-243-00	3	COUPLING, 3/4" HOSE x 3/4" MPT	-
29	68-232-00	7	COUPLING, 3/4" HOSE x 1-1/16" F JIC	-
30	68-240-02	2	ADAPTER, -6 MPT x -6 MPT	-6 MP 2-3 T.F.F.T.
31	68-240-00	2	ADAPTER, -12 MPT x -8 FPT	-12 MP 2-3 T.F.F.T.
32	68-189-01	2	TEE, -12 FPT x -12 FPT x -12 FPT	-
33	67-171-00	1	BULKHEAD FITTING, 3/4 MPT	DRILL HOLE IN WATER TANK TO MOUNT
34	90-098-58	1	ADAPTER, -8 NPT (M) x -8 NPT (M)	-8 MP 2-3 T.F.F.T.
35	90-218-80	1	ADAPTER, -12 JIC (M) x -12 NPT (F) 90°	-12 MP 2-3 T.F.F.T.; -12 JIC TORQUE 78 FT.-LB.

USE THREAD SEALANT ON ALL NPT CONNECTIONS

NOTE: PRE-09/07 PRODUCTION ONLY.

TITLE: PRESSURE WASHER SCHEMATIC		MATERIAL: AS NOTED	
DRN: GEARHART	DATE: 2-20-03	FINISH: N/A	SCALE: 1:8
REV. 8	DATE: 11/06/07	ECO NO. 1029	APR.

DIMENSIONAL TOLERANCES:
XXX ±.005 ANGLES ±15 MIN.
XX ±.010 RUNOUT .003
X ±.015 FRACTIONS ±1/32
UNLESS SPECIFIED

E.H.WACHS Co.
WHEELING, IL

D77SWIVEL-PWA

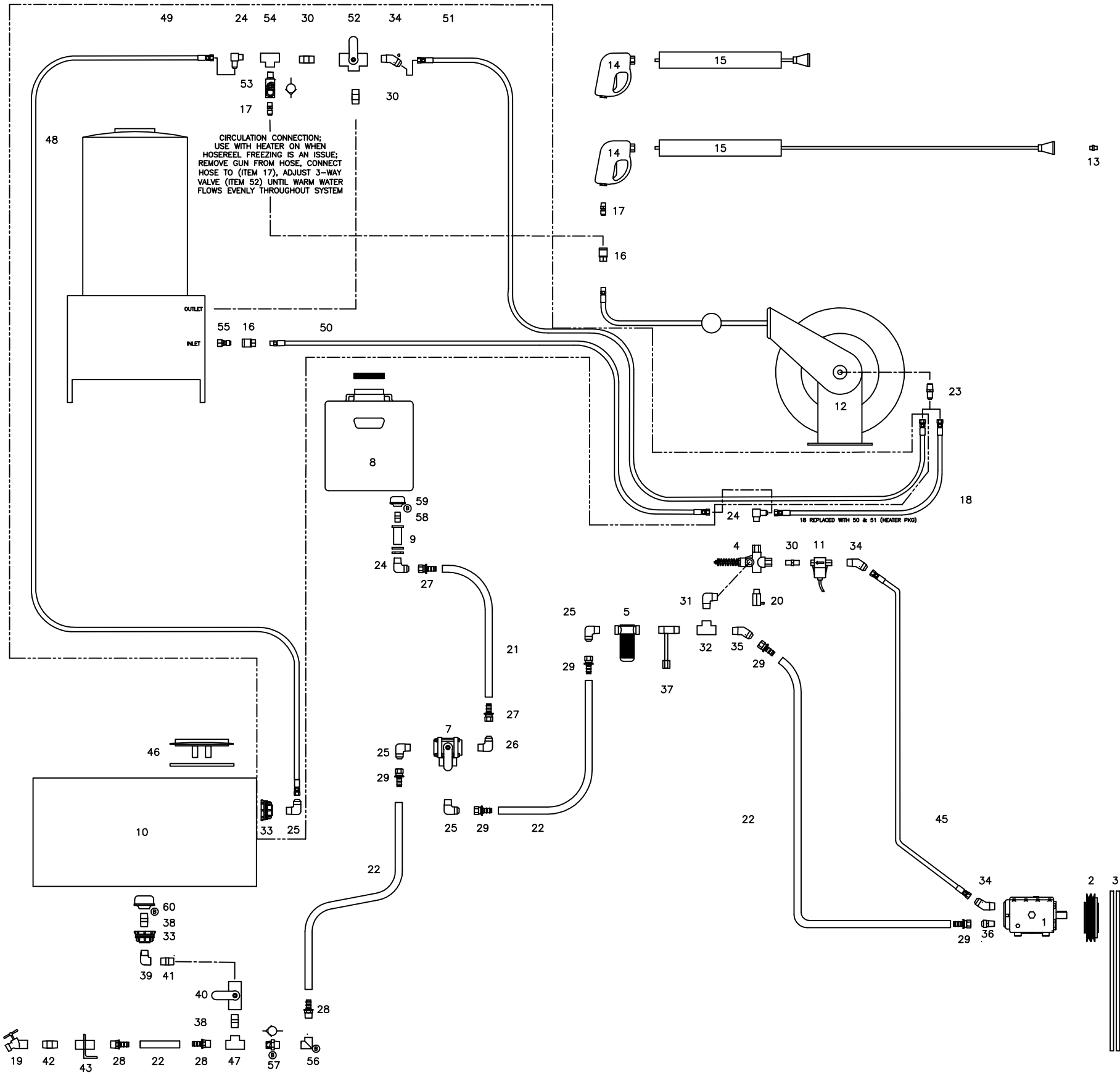

REF. No.	PART No.	QTY.	DESCRIPTION	INSTALLATION NOTES
1	77-085-00	1	PUMP, 2.6 GPM; 3000 PSI	FILL WITH 14.0 OZ NON-DETERGENT SAE 30 OIL
2	77-100-00	1	CLUTCH, 12 VDC	REFER TO DRAWING 02-081-101 FOR INSTRUCTIONS
3	77-127-00	2	BELT, AX41	V1505: NEW BELT STATIC TENSION 57.6/61.7 LB V2003T: NEW BELT STATIC TENSION 62.2/66.6 LB
4	68-137-00	1	UNLOADER VALVE	68-139-00 KNOB (NOT SHOWN)
5	68-138-01	1	STRAINER	DISCONTINUED AFTER 9/08
6	68-140-00	1	THERMAL VALVE	DISCONTINUED AFTER 8/08
7	68-141-00	1	3-WAY VALVE	2-3 T.F.F.T.; MOUNT TO BRACKET (77-068-01)
8	68-146-00	1	ANTI-FREEZE TANK	DRILL Ø1/16" HOLE IN CAP FOR VENTING
9	68-168-00	1	BULKHEAD FITTING, 1/2" NPT	DRILL HOLE IN ANTI-FREEZE TANK TO MOUNT
10	77-162-01	1	WATER TANK	-
11	68-188-00	1	FLOW SWITCH	NOTE FLOW DIRECTION; WIRE TO ELECTRICAL BOX
12	68-195-00	1	HOSE REEL w/ 50' 3/8" HOSE	-
13	68-196-00	1	NOZZLE, .040 x 15'	-
13	77-227-00	1	NOZZLE, .100 x 40'	-
13	77-130-00	1	NOZZLE, .030 x 30'	-
13	77-130-01	1	NOZZLE, .030 x 0'	-
14	68-199-00	1	SPRAY GUN	-
15	68-200-00	1	LANCE	60"
15	77-225-00	1	LANCE	20"
16	68-201-00	2	3/8" FPT BRASS COUPLER	2-3 T.F.F.T.
17	68-202-00	2	3/8" MPT-M BRASS NIPPLE	2-3 T.F.F.T.
18	77-193-11	1	HOSE ASSEMBLY (24" OVERALL)	-8 JIC TORQUE 78 FT.-LB,
19	68-242-00	1	DRAIN COCK	2-3 T.F.F.T.; THREAD ONTO 3/4" PIPE
20	68-193-00	1	SAFETY RELIEF VALVE	SET VALVE AT 4200 PSI
21	68-184-02	16	1/2" LOW PRESSURE PUSH ON HOSE	-
22	68-233-00	145	3/4" LOW PRESSURE PUSH ON HOSE	-
23	68-182-07	1	ADAPTER, -8 MJ x -6 MPT	-6 MP 2-3 T.F.F.T.; -8 JIC TORQUE 34-38 FT.-LB.
24	68-182-04	3	ADAPTER, -8 MJ x -6 MPT 90°	-6 MP 2-3 T.F.F.T.; -8 JIC TORQUE 34-38 FT.-LB.
25	90-128-75	4	ADAPTER, -12 MJ x -12 MPT 90°	-12 MP 2-3 T.F.F.T.; -12 JIC TORQUE 78 FT.-LB.
26	68-182-01	1	ADAPTER, -8 MJ x -12 MPT 90°	-12 MP 2-3 T.F.F.T.; -8 JIC TORQUE 34-38 FT.-LB.
27	68-183-00	2	COUPLING, 1/2" HOSE x 3/4-16 F JIC	-8 MP 2-3 T.F.F.T.; -12 JIC TORQUE 78 FT.-LB.
28	77-129-00	3	COUPLING, 3/4" HOSE x 3/4" MPT SW	-12 MP 2-3 T.F.F.T.; -12 JIC TORQUE 78 FT.-LB.
29	68-232-00	5	COUPLING, 3/4" HOSE x 1-1/16" F JIC	JIC TORQUE 78 FT.-LB.
30	68-240-02	3	ADAPTER, -6 MPT x -6 MPT	MP 2-3 T.F.F.T.
31	90-218-13	1	ADAPTER, -6 NPT (M) x -12 NPT (M) 90°	MP 2-3 T.F.F.T.
32	68-189-01	1	TEE, -12 FPT SCH 80	MP 2-3 T.F.F.T.
33	67-171-00	2	BULKHEAD FITTING, 3/4 MPT	DRILL HOLE IN WATER TANK TO MOUNT
34	68-182-06	3	ADAPTER, -6 NPT (M) x -8 JIC (M) 45°	-6 MP 2-3 T.F.F.T.; -8 JIC TORQUE 34-38 FT.-LB.
35	68-182-05	1	ADAPTER, -12 NPT (M) x -8 JIC (M) 45°	-12 MP 2-3 T.F.F.T.; -8 JIC TORQUE 34-38 FT.-LB.
36	68-240-01	1	ADAPTER, -8 NPT (M) x -12 JIC (M)	-8 MP 2-3 T.F.F.T.; -12 JIC TORQUE 78 FT.-LB.
37	77-163-40	1	WLDMT, MANIFOLD 3/4 MPT	BEFORE 9/08
37	77-163-43	1	WLDMT, MANIFOLD 3/4 FPT	AFTER 9/08
38	90-218-18	2	NIPPLE, CLOSE 3/4 MPT PVC	-12 MP 2-3 T.F.F.T.
39	90-218-16	1	ADAPTER, -12 MPT x -12 MPT STREET 90°	-12 MP 2-3 T.F.F.T.
40	90-218-14	1	VALVE, 3/4 PVC	THREAD ONTO 3/4" NIPPLES
41	90-218-19	1	NIPPLE, 2" LONG 3/4" NPT, PVC	-12 MP 2-3 T.F.F.T.
42	90-218-02	1	NIPPLE, 3/4 MPT GALV	-12 MP 2-3 T.F.F.T.
43	77-105-01	1	ADAPTER, 3/4 MPTF (PART OF TRAILER WLDMT)	-
44	90-218-17	0	ADAPTER, -12 MPT SCH 80 POLY STREET 45°	DISCONTINUED AFTER 8/08
45	77-193-12	1	HOSE ASSEMBLY (18 1/4" OVERALL)	-8 JIC TORQUE 34-38 FT.-LB,
46	77-162-11	1	LID ASSEMBLY, WATER TANK, 4"	-
46	77-162-10	1	LID ASSEMBLY, WATER TANK, 8"	-
47	90-218-15	1	TEE, 3/4 MPT POLY	-
48	77-280-00	1	HEATER, HOT WATER	-
49	77-193-13	1	HOSE ASSEMBLY (126 1/2" OVERALL)	-8 JIC TORQUE-34-38 FT.-LB,
50	77-193-15	1	HOSE ASSEMBLY (82 1/2" OVERALL)	-8 JIC TORQUE 34-38 FT.-LB,
51	77-193-14	1	HOSE ASSEMBLY (105 1/2" OVERALL)	-8 JIC TORQUE 34-38 FT.-LB,
52	90-078-85	1	3-WAY VALVE HP	ADJ VALVE TO ACHIVE DESIRED FLOW
53	90-078-90	1	ONE-WAY VALVE HP	2-3 T.F.F.T.
54	90-078-68	1	TEE, -6 FPT SCH 80	-
55	68-202-50	1	3/8" FPT BRASS NIPPLE	2-3 T.F.F.T.
56	90-218-20	1	ELBOW, 90° 3/4" FPT SCH 80 POLY	AFTER 8/08
57	90-218-21	1	CHECK VALVE, 3/4" NPT	AFTER 8/08, NOTE FLOW DIRECTION
58	90-098-14	1	NIPPLE, CLOSE 1/2" NPT, PVC	AFTER 9/08
59	68-138-02	1	SUCTION STRAINER, ANTI-FREEZE TANK	AFTER 9/08
60	68-138-03	1	SUCTION STRAINER, FRESH WATER TANK	AFTER 9/08

USE THREAD SEALANT ON ALL NPT CONNECTIONS

NOTE: PLUMBING SCHEMATIC FOR HEATER PACKAGE 77-414-00 (POST 08/07 PRODUCTION DATES)

TITLE: PRESSURE WASHER SCHEMATIC	
DATE: 08/26/08	DATE: 01/30/08
BY: U1068	BY: S/M/W
CHKD: U1043	CHKD: S/M/W
DATE: 04/14/08	DATE: 01/30/08
REV: 1	REV: 1

AS NOTED

SCALE

DIMENSIONAL TOLERANCES
 JOG ±.005 ANGLES ±15 MIN.
 JIC ±.010 ROUNDF 303
 X ±.015 FRACTIONS ±1/32
 UNLESS SPECIFIED

E.H.WACHS Co.
HARVARD, IL

D77SWIVEL-PWC

Chapter 9

Accessories and Spare Parts

OPTIONS

The following equipment options are available with the standard VMT-1 trailer system (77-000-21).

Table 1: VMT-1 Optional Equipment

Description	Part Number
Hydraulic pump/reservoir	77-412-00
Hydraulic hose reel assembly	77-413-00
Light bar and controller	77-410-00
Locking job box	77-415-00
Spare tire kit	77-411-00
Water heater	77-414-00
TM-7 valve exerciser	17-000-07
ERV-750 valve exerciser	79-000-01

The upgraded VMT-1 trailer system (77-MAN-22) includes the hydraulic pump, hydraulic hose reel, light bar, locking job box, and spare tire options listed above. The other options listed above are also available.

In This Chapter

OPTIONS

ACCESSORIES

REPLACEMENT PARTS

ACCESSORIES

The following accessories are available for the VMT-1 trailer, including the optional valve exercisers. Also refer to the TM-7 and ERV-750 manuals.

Table 2: VMT-1 Accessories

Part Number	Description
68-409-03	3" Emulsifier wand
68-405-24	.875" x 6 ½' wand
68-405-23	1.25" x 6 ½' wand
68-405-22	2" x 6 ½' wand
68-405-21	2.5" x 6 ½' wand
68-405-06	3" x 6 ½' wand
68-405-34	.875" x 10' wand
68-405-33	1.25" x 10' wand
68-405-32	2" x 10' wand
68-405-31	2.5" x 10' wand
68-405-10	3" x 10' wand
68-407-06	3" x 6 ½' PVC wand
68-407-08	3" x 8' PVC wand
68-407-10	3" x 10' PVC wand
79-411-00	Non-submeter GPS kit
79-412-00	Submeter GPS kit
11-408-00	Telescoping key
17-078-00	Drive adaptor
17-074-04	4' Low clearance key
17-074-06	6' Low clearance key
17-074-08	8' Low clearance key

REPLACEMENT PARTS

Following is a list of replacement parts. These items wear or could be damaged with use and should be replaced periodically. It is also advisable to maintain an inventory of spare parts. Recommended spares and quantities are denoted by an asterisk (*) in the quantity column.

Table 3: VMT-1 Replacement Parts

Part No.	Description	Qty.
17-061-30	Spider, Lovejoy Coupling, Hydraulic Motor	1*
17-088-00	Gas Tank, Red Plastic	1
17-088-01	Cap, Gas Tank	1
67-006-01	Filter Cartridge	1*
67-020-00	Cover, Filter Cartridge	1*
67-051-00	Battery Enclosure, Main Battery	1
67-093-02	Clamp, 4" Band Lock	1
67-093-03	Gasket, Coupler, 4" Band Lock	1*
67-093-06	Plug, Male, 4" Band Lock	1
67-093-07	Gasket, 4" Band Lock Plug	1*
68-018-00	Gasket, Dome, Spoils Tank, Old Style, Figure 7-4	1
68-020-01	Cage, 6" Ball, Spoils Tank, Old Style, Figure 7-4	1
68-106-00	6" Ball, Spoils Tank	1
68-108-00	Gasket, 42" Door, Spoils Tank	1
68-108-50	RTV Silicone, Door Gasket, Spoils Tank	3
68-113-00	Sight Glass, Spoils Tank Door	1
68-125-00	Knob, Retaining, Spoils Tank Lid	1
68-126-00	Clamp, Hinge Pin, Spoils Tank	6
68-132-20	Solenoid, Hydraulic Power Unit, Spoils Tank	4
68-139-00	Knob, Retaining, Filter Cartridge	1
68-146-01	Lid, Priming Tank	1
68-153-00	3" Ball Valve, Spoils Tank/Trailer	2
68-160-03	Hose, 3" Vacuum	Sold Per Inch*

Table 3: VMT-1 Replacement Parts

Part No.	Description	Qty.
68-195-10	Hose Assem, 50' Replacement, Hose Reel	1
68-195-20	Swivel Assem, Water, Hose Reel	1
68-226-00	Breakaway Kit w/Battery, Trailer Brakes	1
68-227-00	Junction Box, Trailer Wiring	1
77-072-50-11	Seal, 6" Ball, New Style	1
77-072-50-12	Seal, Dome, New Style	1
77-101-10	Cover, Air Filter, 27Hp Kohler	1
77-101-50	Ignition Key, 27Hp Kohler	1
77-107-00	Rod End, 3/8 SS, Filter Door	3
77-111-50	Belt, AX41, Blower, Side Mount Gas Engine	2*
77-111-52	Belt, AX35, Front Mount Engine	4*
77-113-00	Muffler, 27Hp Kohler	1
77-114-00	Cage, Muffler, 27Hp Kohler	1
77-117-00	Wing Nut, 3/8-16, SS, Filter Door	3
77-127-00	Belt, AX37, Pressure Washer, Side Mount Gas Engine	2*
77-131-00	Pipe Extension, Muffler, 27Hp Kohler	1
77-132-00	Clamp, Pipe Extension, Muffler, 27Hp Kohler	1
77-148-00	Gasket, Door, Filter Cartridge	1
77-162-50	Seal, 6" Ball, Spoils Tank, Old Style, Figure 7-4	1
77-175-00	Bumper, TM-7 Stop	1
77-176-00	Tire, 7000lb., Assembled	2
77-176-20	Hub Cover, Tire	2
77-180-00	Bar, Pivot, Spoils Tank	2
77-186-00	Rain Cap, Muffler, 27Hp Kohler	1
77-214-00	Light Kit, Trailer Wiring	1
77-261-06	Knob Assembly, Rear Tool Box Door	1
77-279-20	Fuel Tank, Black, 10 Gallon	1
77-401-05	Door, Enclosure, Controller, Light Bar, Plastic	1
77-401-10	Bulb, Light Bar	8*
77-401-15	Controller, Light Bar	1

Table 3: VMT-1 Replacement Parts

Part No.	Description	Qty.
90-054-05	Set Screw, Door Clamp Pivot Bolt, Spoils Tank	2
90-079-90	Pin, 3/8 x 1, Clevis, Filter Door	3
90-095-60	Nylon Washer, Lid, Spoils Tank	1
90-136-25	Hinge Pin, Door, Spoils Tank	2
90-137-17	Bolt, Door Clamp Pivot, Spoils Tank	2
90-500-05	Grease Fitting, 1/4-28, Spoils Tank	4

* Recommended Spares



Chapter 10

Ordering Information

.....

To place an order, request service, or get more detailed information on any E.H. Wachsy products, please contact us at one of the following numbers:

U.S. 800-323-8185
International: 847-537-8800

Or visit our Web site at:

www.ehwachs.com

ORDERING REPLACEMENT PARTS

When ordering parts, please provide the part description and part number for all parts to be ordered.

In This Chapter

ORDERING REPLACEMENT PARTS

REPAIR INFORMATION

WARRANTY INFORMATION

RETURN GOODS ADDRESS

REPAIR INFORMATION

Please call for an authorization number before returning any equipment for repair or factory service. We will advise you of shipping and handling. Include the following information when returning equipment:

- Your name/company name
- Your address
- Your phone number
- A description of the problem or the work to be done.

An estimate of the work to be performed and the associated cost will be provided prior to commencement of service or repairs.

WARRANTY INFORMATION

Enclosed with the manual is a warranty card. Please complete the registration card and return it to E.H. Wachs. Retain the owner's registration record and warranty card for your information.

RETURN GOODS ADDRESS

Use the following address to return equipment for repair:

E.H. Wachs
600 Knightsbridge Parkway
Lincolnshire, IL 60069



600 Knightsbridge Parkway • Lincolnshire, IL 60069
847-537-8800 • www.ehwachs.com