

E.H. WACHS



E.H. WACHS®

Superior Equipment. Complete Support.™

PORTABLE WELD PREP MACHINE TOOLS

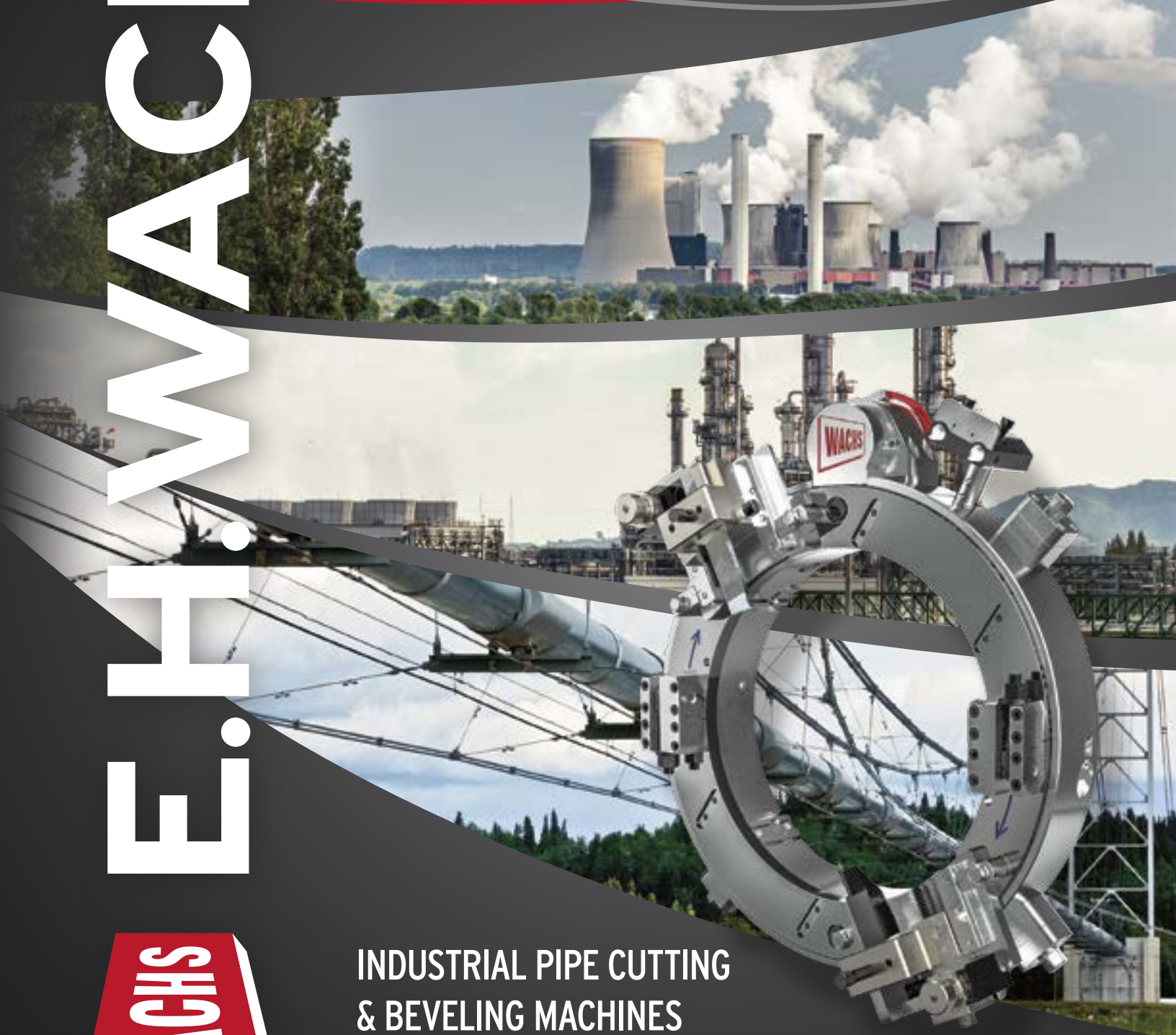

WACHS

**INDUSTRIAL PIPE CUTTING
& BEVELING MACHINES**

ehwachs.com



SDSF Small Diameter Split Frame



DynaPrep MDSF Split Frame



LDSF Large Diameter Split Frame
for pipe & vessels



Early cutting with Trav-L-Cutter

This edition of the E.H. Wachs Industrial pipe cutting and beveling catalog features an array of products designed for the professional field machinist. This catalog highlights the complete lineup of Wachs split frames with the SDSF, DynaPrep® MDSF and LDSF offering standard sizes to cover a full .5in to 120in (DN15-1500) range of tube, pipe or vessel outside diameters.

The DynaPrep MDSF Modular Design Split Frame line is designed to fit pipe OD sizes from 2in to 72in OD (DN50-1800). Building on the strength of its predecessor the LCSF Low Clearance Split Frame, the MDSF redefines the category of split frame, clamshell type pipe cutter/bevelers with more power, more features, greater ease of use, and the option for true remote control across all three drive types, pneumatic, hydraulic and electric.

The DynaPrep is flanked by the SDSF Small Diameter Split Frame for diameters ranging from .5in to 6in (DN15-150), and by the LDSF Large Diameter Split Frame for larger diameters (60in to 120in or DN1500-6000). The combination of these three product lines, along with their advanced accessories, combine to form the industry's most complete portable field machining system. E.H. Wachs offers a machine tool to handle most of the applications encountered in the field, without the need or expense of a custom solution.

As the foundation of our portable machining system, Wachs split frames can be configured to cut, bevel, cut and bevel simultaneously, counterbore, face, record groove, remove socket welds, perform chipless cutting, trepanning, and cut casings externally and internally for wellhead completion, to name just a few. Bring us your toughest application - we probably have a machine for it.

In addition to building the most comprehensive line of split frames offered anywhere, E.H. Wachs products include our famous Guillotine® pipe saws and the Trav-L-Cutter®, industry favorites that continue to fill the needs of professionals around the globe. ID mounted end prep machine tools include our class leading EP 424 with its unique SpeedPrep™ autofeed system, and the proven SDB series that can be converted to FF series flange facers. Wachs RS-2 (rising stem) and P-2 handheld valve operators return with new options for control and monitoring valve activity.

Sold and supported worldwide (with most available for rental), E.H. Wachs products are built to world class standards under ISO 9001. Now available locally at our regional Sales, Service and Rental Centers, Wachs machines are quickly available when and where you need them.



ISO 9001

COMPLETE Support

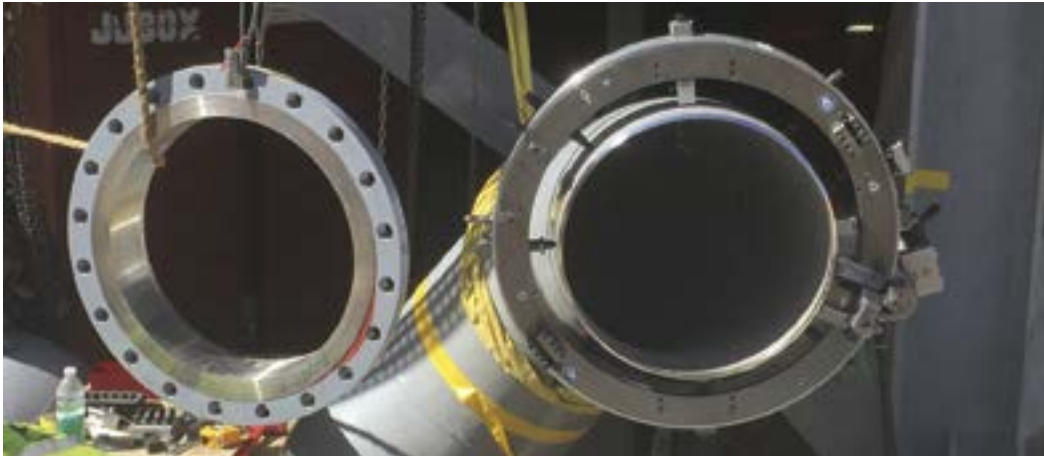

Early pipe fitting

E.H. Wachs based in Lincolnshire, Illinois and Orbitalum Tools based in Singen, Germany combine to form ITW Orbital Cutting & Welding. Orbitalum (formerly known as GF) is the leading manufacturer of high purity cutting products and orbital welding systems. Together we offer our users One Source for the products used to Cut. Prep. Weld.

ITW Orbital Cutting & Welding joins other welding related companies in the ITW Welding products group, further strengthening its position as the premier global supplier of advanced welding solutions. ITW Welding is a unit of Illinois Tool Works, a Fortune 200 global industrial manufacturer with operations in 58 countries and 60,000 worldwide employees. As a Division of ITW, E.H. Wachs benefits from their strong leadership, financial strength and global engineering, sales and product resources.

When you purchase an E.H. Wachs® product, you're partnering with the industry leader in portable weld prep machine tools. That partnership means the equipment you buy today will be supported with the training, service, parts and upgrades that keep these machines working in the field, day in and day out, year after year.

Incorporated in 1883, E.H. Wachs has been manufacturing quality products for over 135 years. Each product builds on the strength of the previous generation, while incorporating new technologies, materials and innovations to advance the power and versatility of these superb machine tools. Our DynaPrep MDSF has so many unique features it makes lesser machines look and feel outdated. New modules for the MDSF help future-proof your investment - our FFC and FFR modules, for example, add flange facing and ring grooving capabilities, often saving the need to bring multiple machines onsite.

At Wachs we back up our motto of Complete Support each and every day. We support our standard machines with a great warranty, but support means more at Wachs – support means partnering with a manufacturer who understands what it takes to complete a project on time and under budget. Like the ability to rent machines, to manufacture custom tooling, to modify standard products, or design and build customized machining solutions.

Support includes training options, at your location or ours. And support also means that, unlike other machine tool manufacturers, when you partner with E.H. Wachs for equipment you're not competing against us for service. At Wachs we take pride in saying we don't just build machines, we build relationships - one customer at a time.



Field machining today with Wachs Split Frames



DynaPrep MDSF machine tool



Cut Vertically or Horizontally



Power Generation



Oil & Gas



Pipeline Distribution



High Purity Process Pipe

ITW Orbital Cutting & Welding products cover a wide range of applications in a broad spectrum of industries. E.H. Wachs and Orbitalum offer machines and accessories to perform facing, counterboring, flange facing and high purity cutting and welding. Used in construction, maintenance and repair operations (MRO) and decommissioning, our primary markets include:

Oil & Gas

Upstream, midstream and downstream, anywhere pipe and vessels are employed you'll find Wachs products. Our experience in Oil & Gas dates back to 1949 with the introduction of our revolutionary Trav-L-Cutter, designed to replace hot torch cutting and grinding. Today E.H. Wachs remains at the forefront of cold cutting machine tool technology, and is the superior choice anywhere volatile hydrocarbons are present. E.H. Wachs builds machine tools specifically for wellhead completion, maintenance and repair, and valve exercising and operation.

Power Generation

E.H. Wachs machine tools are optimized for power generation, and built to deliver more power and precision for these demanding schedules, materials and processes. Many machines are designed with remote control options to conform to ALARA, distancing the operator from risks related to extreme environments.

Pipeline Distribution

Pipelines and the materials they transport are a vital part of the energy landscape. E.H. Wachs products are ideal for construction, repair and replacement activities on the extensive network of gathering, transportation and distribution pipelines carrying oil, natural gas and petrochemical products. Heavy duty and large diameter split frames and pipe saws are offered to tackle the biggest jobs.

High Purity

High Purity includes those industries that make use of high alloy and stainless steel tubing. These applications typically require perfectly executed, highly repeatable and measurable welds, often subject to the most rigorous record keeping and inspection requirements. The Orbitalum product line is the ideal solution for these demanding projects, and include precision tube saws and facers, power supplies, open and closed weld heads and accessories. They see wide application in industries including Semiconductor, Aerospace, Pharmaceutical, and Food, Dairy and Beverage.

CONTENTS

About E.H. Wachs Inside Front Cover

About ITW Orbital Cutting & Welding .. 2

Table of Contents 3

OD Mounted Machine Tools..... 4

OD Mounted Machine Ranges 5

SDSF Small Diameter Split Frame 6

SDSF Split Frame Features..... 7

SDSF Split Frame Specifications 9

SDSF Split Frame Kits..... 10

SDSF Split Frame Accessories 11

DynaPrep MDSF Split Frame..... 15

DynaPrep MDSF Features..... 18

DynaPrep MDSF Specifications..... 22

DynaPrep MDSF Base Kits..... 24

DynaPrep MDSF Pipeline Base Kits..... 25

DynaPrep MDSF Flange Facing 26

DynaPrep MDSF Accessories 28

DynaPrep MDSF Tooling 31

DynaPrep MDSF Casing Cutting..... 33

ECC External Casing Cutter Kits 34

EICC External / Internal Casing Cutter Kits 35

ECC/EICC Casing Cutter Accessories 36

LDSF Large Diameter Split Frame..... 37

LDSF Split Frame Features..... 39

LDSF Split Frame Specifications 40

LDSF Split Frame Tool Slides 41

LDSF Split Frame Heavy Wall Kits..... 42

Trav-L-Cutter Pipe Cutter 43

Trav-L-Cutter Features..... 44

Trav-L-Cutter Specifications 45

Trav-L-Cutter Tooling 46

Trav-L-Cutter Accessories 47

Guillotine Saw 48

Guillotine Specifications 50

Guillotine Accessories..... 51

ID Mounted Machine Tools 52

ID Mounted Machine Ranges 53

EP 424 End Prep..... 54

EP 424 Tooling 58

SDB Small Diameter Beveler..... 61

SDB 103 End Prep 62

SDB 206 End Prep 63

SDB 412 End Prep 64

FF Flange Facer 65

SDB / FF Accessories..... 67

SDB / FF Tooling 69

Power Options 71

Power Pneumatic 72

Power Hydraulic 74

Power Electric 75

Power Applications 76

Specialty Machines 77

RS-2 Valve Operator 78

P-2 Valve Operator 79

Weld Coupon Station..... 80

Genuine Wachs Tooling 81

Parts & Service 82

Support & Training..... 83

Equipment Rentals 84

Onsite Rentals Inside Back Cover

Contact Locations..... Back Cover

OD Mounted Machine Tools



OD Mounting for Inline Pipe & Vessels

E.H. Wachs machine tools can be specified by the mounting method used - our machines can be broadly divided into OD mounted machines and ID mounted machines. OD mounted machines mount around the outside of a pipe or vessel and, with the exception of Wachs Guillotine saws, are characterized by their ability to simultaneously cut and bevel. This elevates our OD mounted machines into the weld prep category, as opposed to the ID mounted machines which fall largely into the end prep category.

E.H. Wachs OD mounted split frames are more than just cutting tools - they're part of a complete machining system designed to handle most applications encountered by the field machinist. Properly equipped Wachs split frames can perform a wide range of tasks including counterboring and deep counterboring, flange facing, single point machining, axial and radial socket weld removal, trepanning, and external and internal casing cutting, to name a few.

Our OD mounted machines include the entire family of Wachs split frames, three distinct series named for their ability to split in half to mount around inline pipe. From smallest to largest they're the SDSF Small Diameter Split Frame, the DynaPrep MDSF, and the range topping LDSF Large Diameter Split Frame, designed for larger diameters, tanks, and vessels.

Other OD mounted products include our pioneering cold cutting Trav-L-Cutter, which rotates on its drive tensioning chain and can accommodate larger diameters by adding additional chain sections. For destructive cutting our proven Guillotine series of reciprocating saws (widely known in the field as the "Wachs Saw") are unmatched for simplicity and durability.



MDSF Split Frame unbolted for OD mounting



MDSF Split Frame bolted together



Guillotine series reciprocating saws



Trav-L-Cutter Model HE Hydraulic

OD Mounted Machine Ranges

	1/2in (13mm)	12in (305mm)	24in (610mm)	36in (914mm)	48in (1219mm)	60in (1524mm)	72in (1829mm)	90in (2286mm)	120in (3048mm)
SDSF	SDSF 1.0								
	SDSF 2.0								
	SDSF 3.0								
	SDSF 4.0								
	SDSF 5.0								
	SDSF 6.0								
DYNAPREP MDSF	MDSF 206								
	MDSF 408								
	MDSF 610								
	MDSF 612								
	MDSF 814								
	MDSF 1016								
	MDSF 1218								
	MDSF 1420								
	MDSF 1824								
	MDSF 2228								
	MDSF 2632								
	MDSF 3036								
	MDSF 3642								
	MDSF 4248								
	MDSF 4854								
	MDSF 5460								
	MDSF 6066								
MDSF 6672									
LDSF	LDSF 75								
	LDSF 90								
	LDSF 105								
	LDSF 120								
TRAV-L-CUTTER	MODEL E (PNEUMATIC)								
	MODEL HE (HYDRAULIC)								
GUILLOTINE	SUPER C								
	MODEL D								
	SUPER D								
	GOLIATH								

SDSF Small Diameter Split Frame



Axial tool slide accessory
for socket weld removal



Wheel cutting module
accessory for FME cutting



Counterbore attachment
fits all models

Optimized for Low Clearance Environments

E.H. Wachs® SDSF Small Diameter Split Frames are the smallest, most compact member of the Wachs split frame family, and are designed for cutting, beveling and counterboring pipe and tubing from OD 0.5in - 6in (DN 15-150). Six models are available in 1in (25.4mm) increments, with additional sizes by special order.

Like all E.H. Wachs split frame clamshell style machines the SDSF is designed to “split” in half to fit over inline pipe, or can be slipped over open ended pipe. The SDSF serves as the basis of Wachs axial and radial socket weld removal kits that remove the weld filler metal without sacrificing the base material, an important consideration in complex assemblies.



SDSF Split Frame Features

Small Size, Big Capabilities

The SDSF is ideal anywhere pipe and tube are arrayed in tight places and finds many uses in power generation, oil and gas and the shipbuilding industries. Operating on air or electric power using standard Wachs motors and adapters, the SDSF is part of a complete system that includes a broad range of tool slides and accessories for maximum versatility. As with all E.H. Wachs products, the Small Diameter Split Frame is built with Wachs legendary quality and durability for years of reliable service.

Like all Wachs split frames the SDSF is designed to simultaneously cut and bevel pipe and tube with Wachs parting and beveling tool slides. It's also the basis of Wachs specialized Socket Weld Removal kits, in both axial and radial configurations.

Socket Weld Removal

SDSF split frames are the building block of Wachs socket weld removal machines. They're designed to remove couplers and elbows from existing piping systems by machining away the weld material that joins them. This is done without sacrificing the base material – a vital consideration in the repair or modification of complex process systems. These machines incorporate all that we've learned from years of socket weld removal experience. They're the easiest to use and most productive socket weld removal machines offered anywhere.

Foreign Material Exclusion (FME)

Wachs FME (Foreign Material Exclusion) is a chipless wheel cutting module designed for use with the SDSF. FME is critical in high purity and process applications where the introduction of chip debris cannot be tolerated. Examples include the food, dairy and pharmaceutical industries and the highly controlled power generation field.

Portable Pipe Cutting & Beveling

- SDSF quickly splits open to mount around the OD of inline pipe
- Machines carbon steel, stainless steel and alloys, e.g. Hastelloy™, Inconel™ and other high-performance materials
- Cuts and bevels up to 0.438in (11.1mm) wall thickness
- Low clearance design requires minimal space for setup and operation
- Self-squaring pipe clamping system, using either collets or integrated, close tolerance legs with wide feet stability
- Low friction adjustable bearing system provides maximum stability and extended machine life
- Fully enclosed bearing and drive gear system for operational safety
- Modular tool slides
- Lever type trip actuation for safety
- Spring loaded axial trip for crash resistance
- Improved radial trip geometry for crash resistance and durability
- Improved bearing adjustment design
- Improved durability in pinion gear bearing arrangement
- Easier assembly and disassembly of frame halves
- Improved sealing for chip exclusion
- Captive fasteners used for all accessories
- Reduced fastener count for simplified inventory. Only 3 hex wrench sizes required to operate machine
- Rings from 1-6in (DN 15-150) can mount with collets. Clamping feet can be used on 2in (DN30) and up



Front Drive Pinion



Bevel Prep



Socket Weld Removal



FME Wheel Cutting

SDSF Split Frame



UNIVERSAL RIGHT ANGLE DRIVE



ELECTRIC DRIVE



AXIAL FEED TRIP



RADIAL FEED TRIP

STANDARD
PINION



FRONT DRIVE
PINION



CENTERING LEGS & EXTENSIONS



SDSF
RING
SET

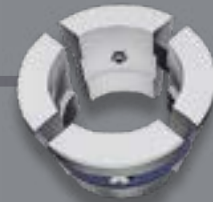

SELF-CENTERING COLLET



COUNTERBORE SLIDE



AXIAL SOCKET WELD
REMOVAL SLIDE



RADIAL SOCKET WELD
REMOVAL SLIDE

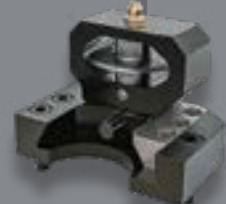

FME CHIPLESS CUTTING
WHEEL SLIDE

SDSF

SDSF Split Frame Specifications

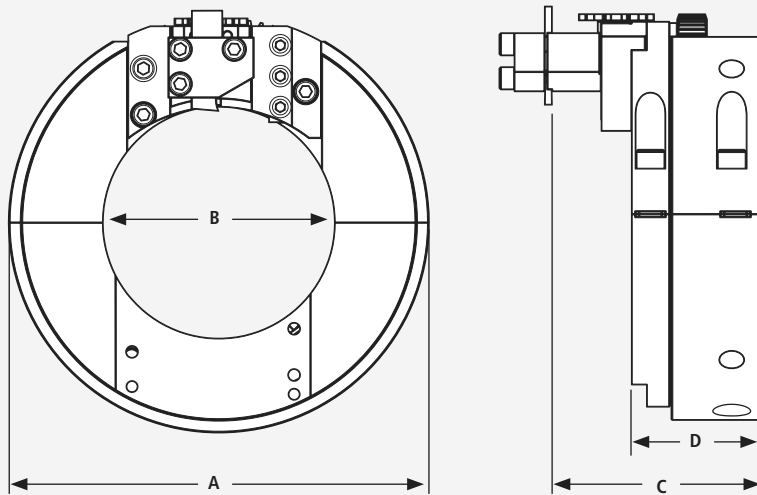

SPECIFICATIONS	SDSF 1.0	SDSF 2.0	SDSF 3.0	SDSF 4.0	SDSF 5.0	SDSF 6.0
Machine Capacity OD	The machine capacity depends on the mounting system and on the operating method.					
"A" Machine OD	5in (127mm)	5.689in (145mm)	6.87in (175mm)	7.815in (199mm)	8.937in (227mm)	9.937in (252mm)
"B" Machine ID	1.563in (40mm)	2.626in (67mm)	3.75in (95mm)	4.752in (121mm)	5.878in (149mm)	6.878in (175mm)
"C" Parting line	3.469in (88mm)					
"D" Machine thickness	2.531in (64mm)					2.154in (55mm)

System Function:

Part off, bevel and counterbore pipe and tube; radial and axial socket weld removal; wheel cutting

Cutting tool surface speed:

10m/min, 2in 40sf/m 4in

Drive options: Pneumatic or electric

Air requirements:

35cfm at 90psi
(1m³/min at 6.2BAR)

Electrical requirements: 230/120V

Feed method: Starwheel

Feed rate: Fixed at 0.0031in (0.079mm) per trip

Construction: Alloy steel

Tool slide: Radial or axial feed, cut and bevel, counterbore, FME module

Tool stroke: 0.468in (11.9mm)

Finish: Hard chrome coating

Tooling: Axial or radial socket weld removal tooling, cut/bevel tooling. High speed steel or carbide

Packaging: Heavy duty carrying case

Optional Equipment

- Pneumatic or electric drive motor
 - Genuine Wachs Tooling
 - Axial feed tool slide
 - Radial feed tool slide set
 - Bench mount
 - Front drive pinion housing
 - Counterbore attachment
 - FME tool slide
 - Aluminum collet sets
 - Clamp pads sets
 - Radial socket weld slide
- Add frames, slides, collets, collet nut and spanner wrench, or clamping feet to complete machine.



SDSF Cut & Bevel



Axial Socket Weld Removal



SDSF Axial Turning



SDSF Counterbore Bevel

SDSF Split Frame Kits

SDSF Split Frame Ring Sets

Add slides, collets or legs*, drive, collet nut and spanner wrench for complete machine. See individual ring size accessory listings on the following pages.

Includes

- Individual Split Frame
- Pinion housing
- Heavy duty, watertight storage / carrying case
- Spare fastener kit
- Hand tools
- Manual

ITEM	PIPE OD	PART #
SDSF Split Frame 1.0*	1in (25mm)	80-4000-10
SDSF Split Frame 2.0	2in (51mm)	80-4000-20
SDSF Split Frame 3.0	3in (76mm)	80-4000-30
SDSF Split Frame 4.0	4in (102mm)	80-4000-40
SDSF Split Frame 5.0**	5in (127mm)	80-4000-50
SDSF Split Frame 6.0**	6in (152mm)	80-4000-60

* COLLET ONLY 1IN (25.4MM) AND BELOW. ** SPECIAL SIZES ON REQUEST.

SDSF Socket Weld Removal

For socket weld removal, available as radial or axial feed kits.

Includes

- Frame assemblies 1in and 2in (DN 25 and DN 50)
- Axial and/or radial feed socket weld removal tool slides
- Aluminum collets for pipes with Ø:
 - 0.5in / 0.75in / 1in / 1.25in / 1.5in / 2in (12.7 / 19.05 / 25.4 / 31.75 / 38.1 / 50.8mm)
- Clamp foot and extension leg kit for 2in (50.8mm) frame*
- 1 Air drive
- Spare fastener kit
- Storage case
- Operating hand tools
- Manual

ITEM	PIPE OD	PART #
SDSF Axial Feed Pneumatic Kit	0.5-2in (12.7-50.8mm)	80-0000-AX
SDSF Radial Feed Pneumatic Kit	0.5-2in (12.7-50.8mm)	80-0000-RA

*COLLET ONLY 1IN (25.4MM) AND BELOW.



Axial Slide for Socket Weld Removal



Wheel Cutting Module for FME Cutting



Standard Storage Case



Counterbore attachment fits all models

SDSF Tool Slide and Trip Assemblies

ITEM	PART #
Tool slide and trip assemblies for SDSF 1.0	
Tool slide and trip assemblies for SDSF 1.0 Radial feed parting tool slide	80-4101-10
Radial feed beveling tool slide	80-4102-10
Radial feed tool slide trip assembly For SDSF 1.0 to SDSF 6.0	80-4103-00
Radial feed tool slide kit includes: • 1 parting slide • 1 beveling slide • 1 trip assembly	80-5101-10
Radial feed socket weld removal tool slide Used with the SDSF for removal of socket welds, the radial slide requires less axial clearance. The tooling is advanced to the pipe center line (radially) to remove the weld material. Also available as a complete Radial Socket Weld Removal Kit	80-4100-10
Axial feed socket weld removal tool slide Used with the SDSF for removal of socket welds, the axial slide requires less radial clearance. The tooling is advanced axially along the pipe to remove the weld material. Also available as a complete axial socket weld removal kit	80-4104-10
Axial feed tool slide trip assembly For SDSF 1.0 to SDSF 6.0	80-4105-00
Axial feed tool slide kit includes: • 1 axial slide • 1 trip assembly	80-5102-10
Universal counterbore slide Designed for perfect counterboring of the pipe or tube inside diameter, the universal counterbore fits all Wachs SDSF ring set. Utilizes a simple and effective hand advance to precisely control the counterbore. For SDSF 1.0 to SDSF 6.0	80-4107-00
Tool slide and trip assemblies for SDSF 2.0	
Radial feed parting tool slide	80-4101-20
Radial feed beveling tool slide	80-4102-20
Radial feed tool slide trip assembly For SDSF 1.0 to SDSF 6.0	80-4103-0
Radial feed tool slide kit includes: • 1 parting slide • 1 beveling slide • 1 trip assembly	80-5101-20
Radial feed socket weld removal tool slide	80-4100-20
Axial feed socket weld removal tool slide	80-4104-20
Axial feed tool slide trip assembly For SDSF 1.0 to SDSF 6.0	80-4105-00
Axial feed tool slide kit includes: • 1 axial slide • 1 trip assembly	80-5102-20
Universal counterbore slide For SDSF 1.0 to SDSF 6.0	80-4107-00
Tool slide and trip assemblies for SDSF 3.0 & SDSF 4.0	
Radial feed parting tool slide	80-4101-40
Radial feed beveling tool slide	80-4102-40
Radial feed tool slide trip assembly	80-4103-00
Radial feed tool slide kit includes: • 1 parting slide • 1 beveling slide • 1 trip assembly	80-5101-40
Trip assembly	80-4104-40



Radial Socket Weld Removal Slide



Axial Socket Weld Removal Slide



Counterbore Tool Slide



Radial Feed Tool Slide Kit

SDSF Split Frame Accessories

SDSF Tool Slide and Trip Assemblies

ITEM	PART #
Axial feed tool slide trip assembly For SDSF 1.0 to SDSF 6.0	80-4105-00
Axial feed tool slide kit includes <ul style="list-style-type: none"> • 1 axial slide • 1 trip assembly 	80-5102-40
Universal counterbore slide For SDSF 1.0 to SDSF 6.0	80-4107-00
Tool slide and trip assemblies for SDSF 5.0 and SDSF 6.0	
Radial feed parting tool slide	80-4101-60
Radial feed beveling tool slide	80-4102-60
Radial feed tool slide trip assembly For SDSF 1.0 to SDSF 6.0	80-4103-00
Radial feed tool slide kit includes <ul style="list-style-type: none"> • 1 parting slide • 1 beveling slide • 1 trip assembly 	80-5101-60
Axial feed socket weld removal tool slide	80-4104-60
Axial feed tool slide trip assembly For SDSF 1.0 to SDSF 6.0	80-4105-00
Axial feed tool slide kit includes <ul style="list-style-type: none"> • 1 axial slide • 1 trip assembly 	80-5102-60
FME (foreign material exclusion) slide	80-4106-60



FME (Foreign Material Exclusion) Slide



Parting tooling standard

SDSF Tooling

ITEM	DIMENSIONS	LENGTH	PART #
Parting Tooling			
Low clearance	1/8 x .5in (3.2 x 12.7mm)	1.63in (41.4mm)	80-7001-01
Standard		2.13in (54.1mm)	80-7001-02
Extended reach		2.63in (66.8mm)	80-7001-03
Bevel Tooling			
Standard 37.5°	3/8 x .5in (9.5 x 12.7mm)	2.13in (54.1mm)	52-710-02
Extended reach 37.5°		2.63in (66.8mm)	52-710-03
Extended reach 30°		2.67in (67.8mm)	52-705-01
Extended reach 45°			52-705-03
Low clearance 37.5°, outside		1.63in (41.4mm)	80-7008-01
Standard 37.5°, outside		2.13in (54.1mm)	80-7008-02
Universal Counterbore Tool			
Counterbore tool taper 4:1 (14°)	-	-	80-7003-01
Socket Weld Removal Tooling, Radial Feed			
Standard, radial	-	-	80-7006-01
Extended reach, radial	-	-	80-7006-02
Low clearance, radial	-	-	80-7006-03
Socket Weld Removal Tooling, Axial Feed			
Standard, axial	3/8 x 3/8in (9.5 x 9.5mm)	2.0in (50.8mm)	80-7007-02
Standard, HSS tool bit, axial For single point facing, beveling and flange facing For use with EP 424, LCSF, FF, SWR and SDSF machines			52-701-01
Standard, axial. Offset dogleg. With 1in (25.4mm) extension		1.5in (38.1mm)	52-701-02
Standard, carbide, axial		1.0in (25.4mm)	52-702-01
Extended reach, axial		2.5in (63.5mm)	80-7007-03
Extended reach, axial. Offset dogleg. With 1 1/4in (31.8mm) extension			52-701-03
FME chipless cutting wheel			80-0053-00



Bevel tooling extended reach 30°



Counterbore tool taper 4:1



FME cutting wheel

SDSF Split Frame Accessories

SDSF Aluminum Collets & Collet Accessories

Please specify when ordering customized tools:

Pipe/tube true OD, material (aluminum, delrin, stainless), collet size markings

COLLETS REQUIRE COLLET NUT AND SPANNER WRENCH WHEN PURCHASED WITH INDIVIDUAL SDSF MACHINE.

ITEM	PART #
Customized aluminum collets for SDSF 1.0-SDSF 6.0	ON REQUEST
Collet kit for SDSF 1.0 Includes: <ul style="list-style-type: none"> Aluminum collets for pipe OD: 0.5in, 0.75in, 1in (12.7, 19.05, 25.4mm) 1 collet nut 1 spanner wrench 	80-5201-10
Collet kit for SDSF 2.0 Includes: <ul style="list-style-type: none"> Aluminum collets for 1.25in, 1.5in, 2in (31.75, 38.1, 50.8mm) Pipe OD 1 collet nut 1 spanner wrench 	80-5201-20
Collet kit for SDSF 3.0 Includes: <ul style="list-style-type: none"> Aluminum collets for 2in, 2.5in, 3in (50.8, 63.5, 76.2mm) Pipe OD 1 collet nut 1 spanner wrench 	80-5201-30
Collet kit for SDSF 4.0 Includes: <ul style="list-style-type: none"> Aluminum collets for 3in, 3.5in, 4in (76.2, 88.9, 101.6mm) Pipe OD 1 collet nut 1 spanner wrench 	80-5201-40
Collet kit for SDSF 5.0 Includes: <ul style="list-style-type: none"> Aluminum collets for pipe OD: 4in, 5in (101.6, 127.0mm) 1 collet nut 1 spanner wrench 	80-5201-50
Collet kit for SDSF 6.0 Includes: <ul style="list-style-type: none"> Aluminum collets for pipe OD: 5in, 6in (127.0, 152.4mm) 1 collet nut 1 spanner wrench 	80-5201-60
Collet nut for SDSF 1.0	80-0007-10
Collet nut for SDSF 2.0	80-0007-20
Collet nut for SDSF 3.0	80-0007-30
Collet nut for SDSF 4.0	80-0007-40
Collet nut for SDSF 5.0	80-0007-50
Collet nut for SDSF 6.0	80-0007-60
Spanner wrench for SDSF 1.0 to SDSF 2.0	90-800-78
Spanner wrench for SDSF 3.0 to SDSF 4.0	90-800-79
Spanner wrench for SDSF 5.0 to SDSF 6.0	90-800-80



Aluminum Collet



Collet Nut for SDSF



Spanner Wrench for SDSF

SDSF Split Frame Accessories

SDSF Motors & Miscellaneous Accessories

ITEM	1.0	2.0	3.0	4.0	5.0	6.0	PART #
Clamp foot and extension leg set Includes: 4 each clamp foot 80 4001 00 4 each extension legs 0.31in (7.9mm) 4 each extension legs 0.56in (14.2mm)		X	X	X	X	X	80-5001-00
Universal right angle air drive motor	X	X	X	X			80-4004-00
Electric motor For SDSF 120V 1500W	X	X	X	X	X	X	80-4005-01
Electric motor For SDSF 230V 1500W	X	X	X	X	X	X	80-4006-01
Front drive pinion housing assembly	X						80-4003-10
		X					80-4003-20
			X				80-4003-30
				X			80-4003-40
					X		80-4003-50
						X	80-4003-60
Universal spare fastener kit.*	X	X	X	X	X	X	80-5500-00
Axial feed tool slide trip assembly	X	X	X	X	X	X	80-4003-30
Universal manual	X	X	X	X	X	X	80-MAN-01
Bevel slide cover assembly. For use with outside bevel tooling	X	X	X	X	X	X	80-4108-00

* KIT BOM'S SUBJECT TO CHANGE BASED ON CURRENT PRODUCTION CONFIGURATION

Cutting Lubrication

Water soluble, biodegradable, non-hazardous, fully synthetic cooling fluid that extends the tooling life.

DESCRIPTION	VERSION	WEIGHT	PART #
Cutting lubrication KSS-TOP	Pump sprayer with 500ml	1.39lb (630g)	0T790.060.226
Cutting lubrication KSS-TOP refill canister	Canister with 10l	24.25lb (11kg)	0T790.060.227



Clamp Foot & Extension Leg Set



Universal Pneumatic Right Angle Drive Motor



Electric Motor for SDSF



Cutting lubrication KSS-TOP

DynaPrep MDSF Split Frame



Slides feature Rapid Adjust and Micro Adjust



Slides accept 1in (25.4mm) square & all popular size tooling



V-Lock ring mating surface resists force distortion

Complete Machining System

E.H. Wachs DynaPrep® MDSF Split Frame redefines the category of cold cutting machine tools for pipe and vessels. Designed for cutting, beveling, facing, counterboring, and flange facing, it's offered in 18 standard models for popular nominal pipe sizes ranging from 2-72in OD (DN50-1800), with each machine covering a generous 6in range.

Engineered to be powerful, strong and lightweight, DynaPrep offers unmatched form tooling capability on heavy wall pipe including high alloy material. Sold as complete kits or individual components the DynaPrep MDSF is available with remote control options in your choice of pneumatic, hydraulic or electric drive.



DynaPrep MDSF Split Frame



DynaPrep MDSF offers enhanced form tool capabilities



Tool-free drive mounting on heavy duty pinion to handle more power



Aluminum stationary frame with steel rotating ring



DynaPrep MDSF tool slides with Rapid Adjust

Advanced Cutting with DynaPrep MDSF

As the needs of the field machinist have evolved, E.H. Wachs products have evolved to meet those needs. Our users asked for stronger form tooling capabilities and a more productive user experience, while delivering greater precision with faster and safer operation. The DynaPrep MDSF Modular Design Split Frame is the latest example of Wachs machine tool innovation that does just that.

The DynaPrep MDSF represents the pinnacle of cold cutting split frame technology. Retaining the class leading portability and versatility that distinguished our LCSF Low Clearance Split Frame, DynaPrep is built tougher to withstand additional torque to pull bigger chips. It offers so many patented features that make it so easy to use you'll wonder why nobody thought of them before.

The DynaPrep MDSF is another in a long string of innovations from the pioneer in portable, cold cutting machining technology. It started with the Trav-L-Cutter, then the industry standard reciprocating Guillotine saw, followed by the ground breaking LCSF split frame.

Portable, Easy to Operate

Unlike heavy steel machines, the DynaPrep MDSF retains the advanced light-weight aluminum and steel construction that maintains the portability and ease of setup and operation that characterized the LCSF. DynaPrep includes system indexing, where major assemblies are indexed to simplify setup and promote repeatability. The tool slides are indexed to the rotating ring, the trip is indexed to the tool slides, making the DynaPrep virtually crash proof.

The DynaPrep tool slides incorporate our exclusive Rapid Adjust™ feature, where a turn of a collar allows for large tooling movement during setup, a real time saver. The Micro Adjust feature on the slide allows fine hand positioning of the tooling, and a tooling spacer block arrangement accepts multiple tooling sizes and types.

Remote Control Options

The DynaPrep MDSF is the first machine designed from the ground up to accommodate remote control operation, conforming to the industry trend of moving operators out of hostile environments and away from rotating machinery. Remote options exist for all MDSF drive types, pneumatic, hydraulic and electric, including remote trip actuation.

DynaPrep MDSF Split Frame

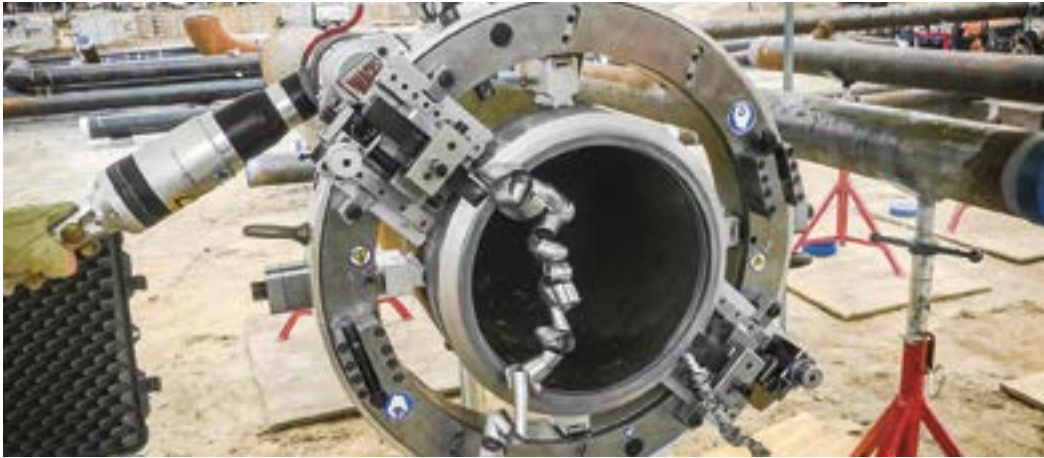

Pipe Cutting

A Complete Pipe Machining System

Wachs DynaPrep MDSF can be used to cut, bevel, single point, counterbore, trepan, flange face and more. With ring sizes capable of machining from 2-72in OD (DN50-1800), it's used in a wide variety of industries including oil & gas, power generation, pipeline distribution, shipbuilding, mining, and anywhere pipe, tube or vessels are present. The DynaPrep MDSF sets the benchmark in portable machine tool systems.

Pipe Cutting

The MDSF is capable of cutting (parting), double parting (utilizing two cutting blades) or simultaneous cutting and beveling.

Pipe Beveling

The DynaPrep quickly and safely creates the more complex weld preps specified today that torching and grinding cannot. The MDSF can be configured to bevel, compound bevel, and create J-Preps with specific radius and precise lands.

Counterboring

Counterboring is the process of machining the ID of pipe, after the weld prep is completed and before the sections are welded. The DynaPrep MDSF offers multiple modules and accessories to perform any type of counterboring.

Flange Facing

The DynaPrep MDSF makes an excellent flange facer, with available modules designed for flat face, raised face, record grooving and machining RTJ grooves. Utilizing the MDSF as the platform saves time and the expense of bringing in dedicated facing machines.

Heavy Wall

With its robust construction and powerful drive motor options, the DynaPrep MDSF is the best choice for machining heavy wall pipe. Depending on the material, it can form tool up to 2.5in (63mm) wall.

Form tooling refers to an operation where the tooling is shaped to the final weld profile desired. This is opposed to single point tooling, where the tip of the tooling (the single point) cuts a narrow track that must travel axially and radially to create the desired profile.



Pipe Beveling



Counterboring



Flange Facing

DynaPrep MDSF Features

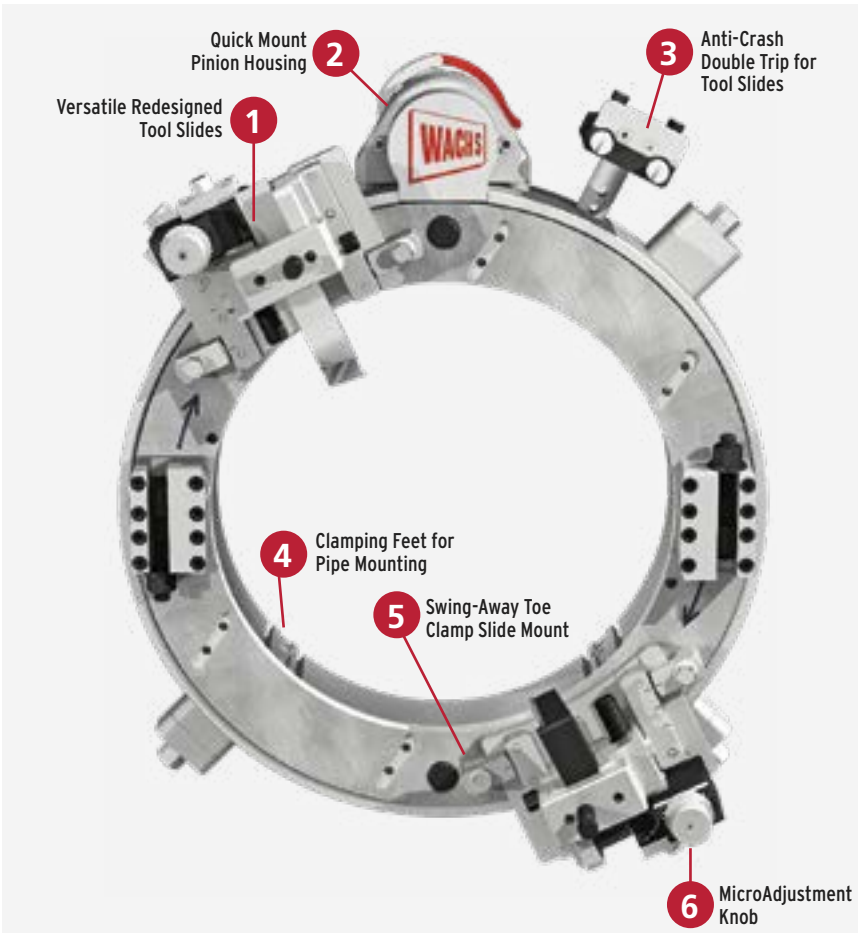

DynaPrep MDSF

- Rugged design with superior form tooling capability
- Gear design withstands force from larger more powerful drive motors
- Ring sizes 20in and below use four clamping feet for squaring
- V-Lock frame mating surfaces allow off-center setup for faster alignment.
- Aluminum fixed ring for portability, steel rotating ring for strength
- Advanced heat treating and anti-corrosion coatings for enhanced durability
- Dual row v-bearing construction for precision and durability
- V-bearings run in a unique hardened steel dual raceway
- Dual raceway design evenly distributes force loading no matter the direction
- Only two sockets, .5in (13mm) and .75in (19mm), needed for setup and operation



1

Accepts most common tooling sizes including 1in (25.4mm) square & .5x 3/4in (12.7 x 19mm)



2

Gear design withstands force from all drive types: Pneumatic, Hydraulic & Electric



3

Anti crash ramp on tool slides retracts dual trips if mispositioned



4

Ring sizes 20in & below use four clamping feet for squaring



5

Captivated, swing-away toe clamp for easier slide mounting



6

Rapid Adjust and Micro Adjust knobs provide greater precision during setup & operation

DynaPrep MDSF Features

DynaPrep MDSF

- V-Lock frame mating surfaces feature angled captivated bolt and keyway
- Ring sizes 24in (610mm) up to 72in (1800dn) use eight clamping feet for squaring and stability
- Indexed, squaring clamping leg design features a 2in (50mm) stroke
- Single clamp pad extension covers a 6in (152mm) pipe diameter range
- Clamp pads mount axially without removing the machine from the pipe
- U shaped feet pair with push in buttons and points for miter or elbow mounting
- Screw feet reverse and accept push in buttons and points
- All models feature replaceable felt wiper for lubrication and to capture chip debris
- Captivated swing bolts allow for fast positioning over inline pipe

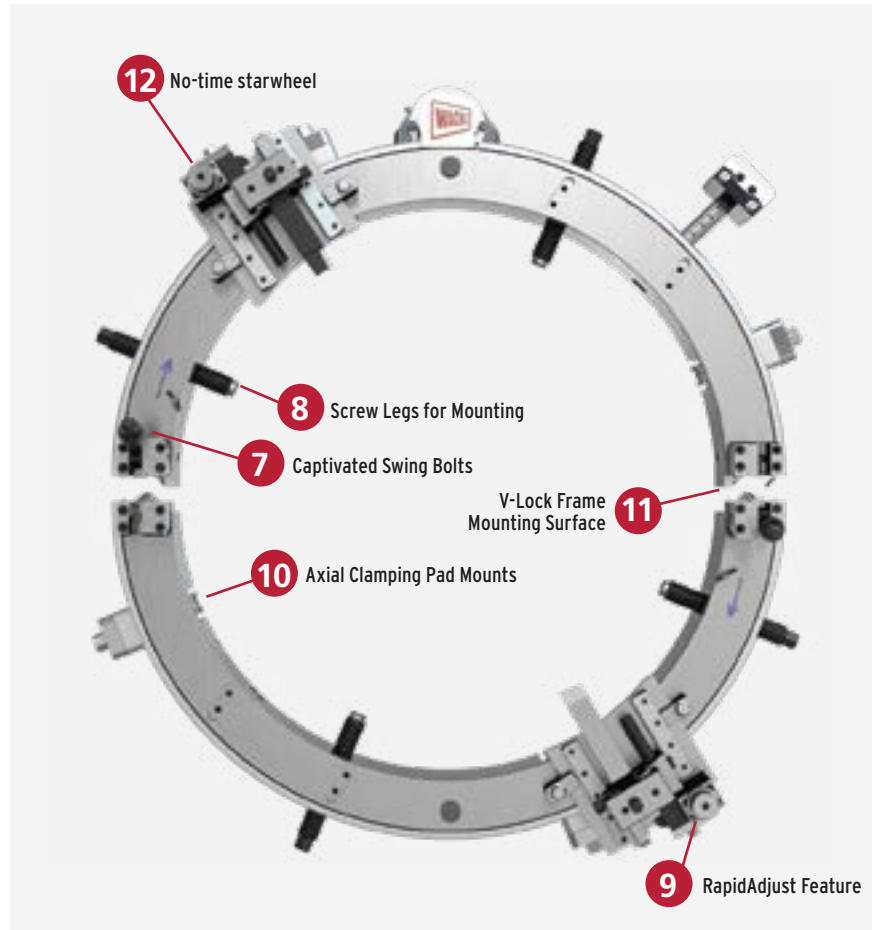

Swing bolts allow for fast positioning over inline pipe

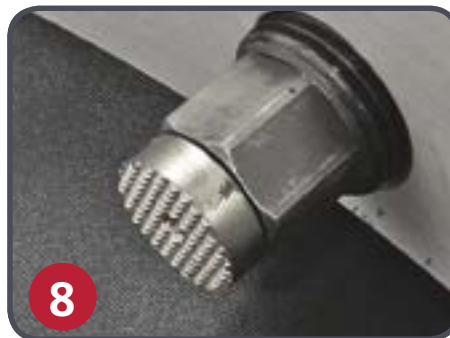

Screw feet reverse and accept push-in buttons & pins



Rapid Adjust feature speeds positioning of tooling



Clamp pads mount axially without removing the machine from the pipe



Patent pending V Lock ring mating surfaces are easier to join & stronger



No-time starwheel tool advance is designed to work with the anti-crash trip

DynaPrep MDSF Split Frame

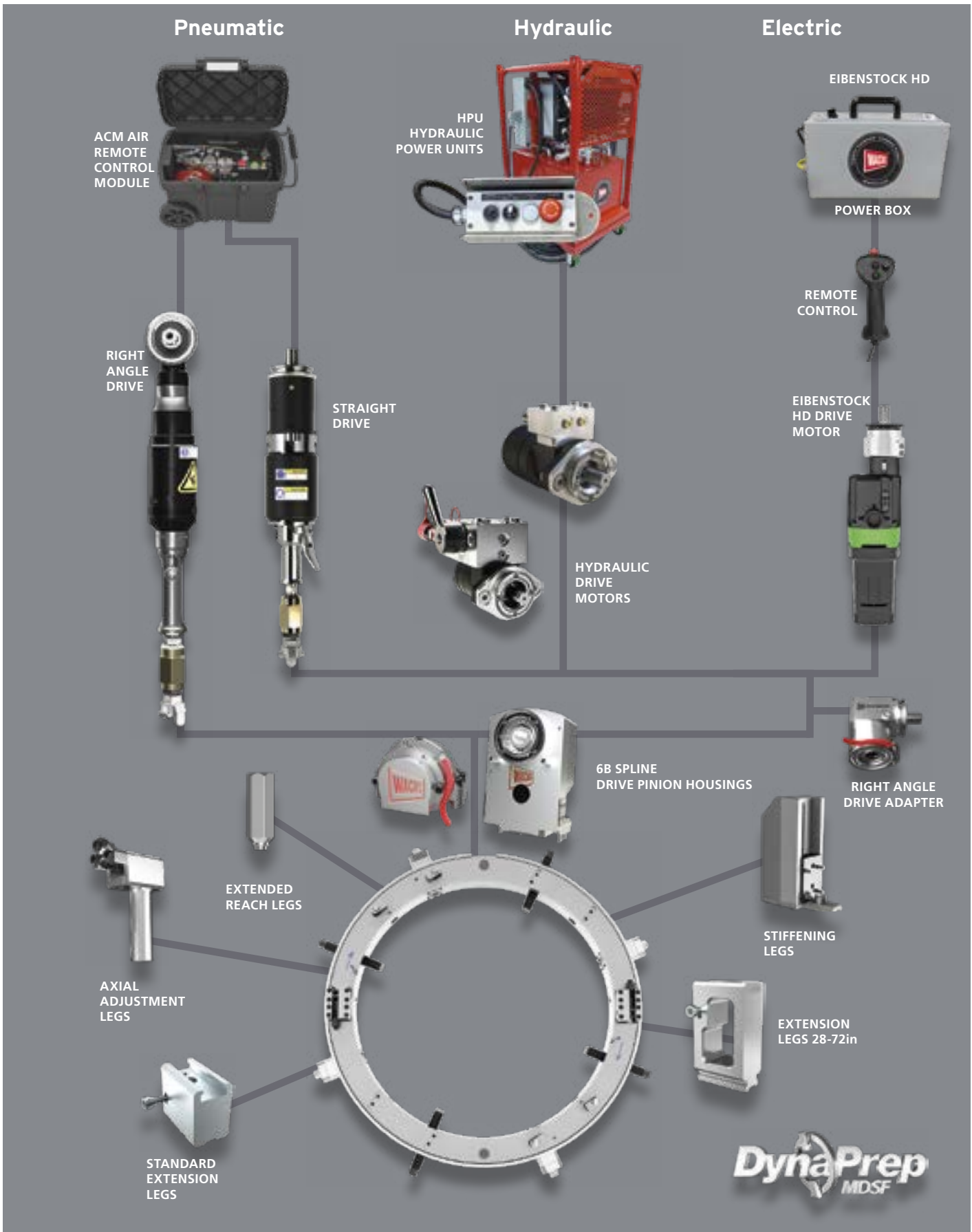

DynaPrep MDSF Split Frame

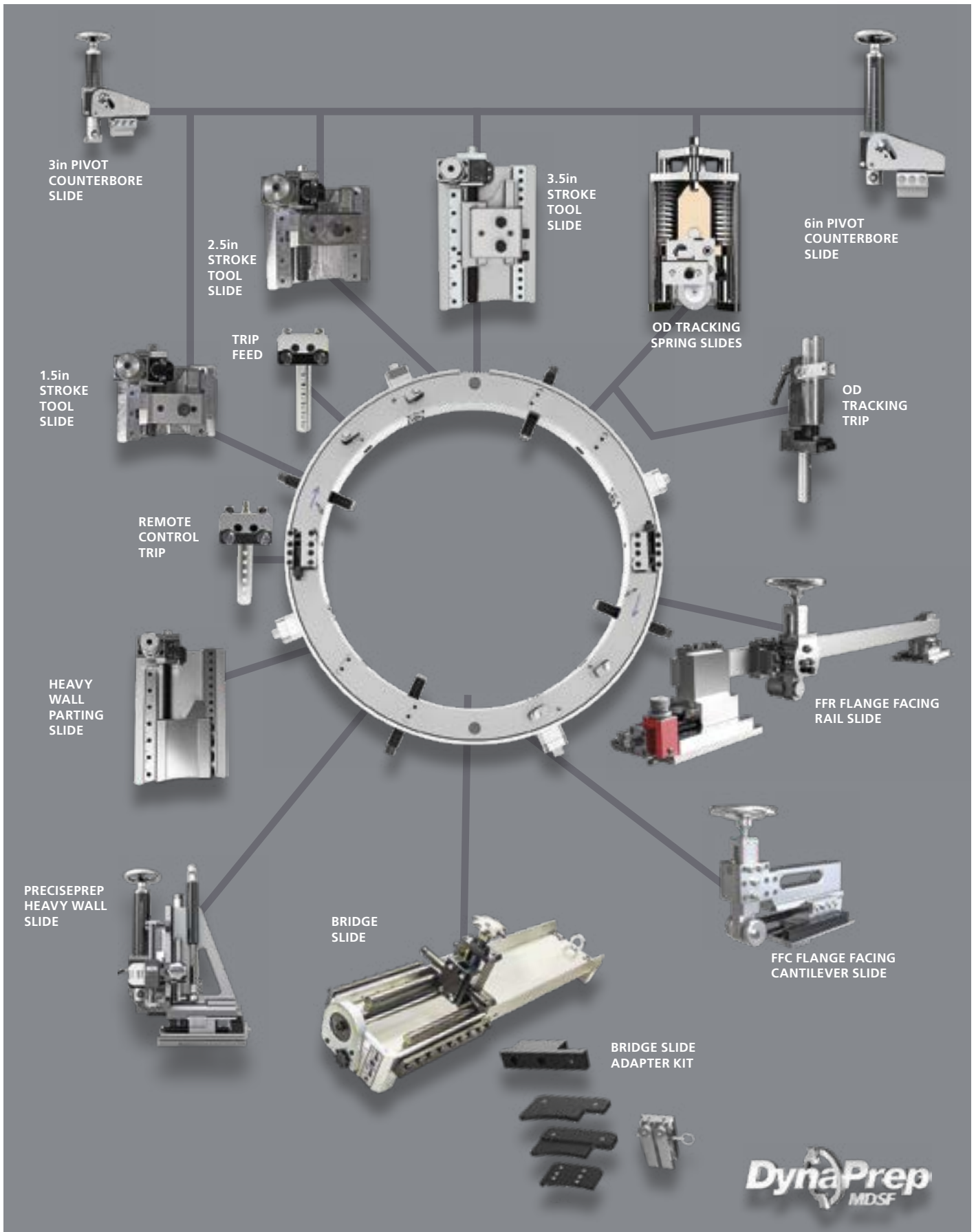

DynaPrep MDSF Specifications

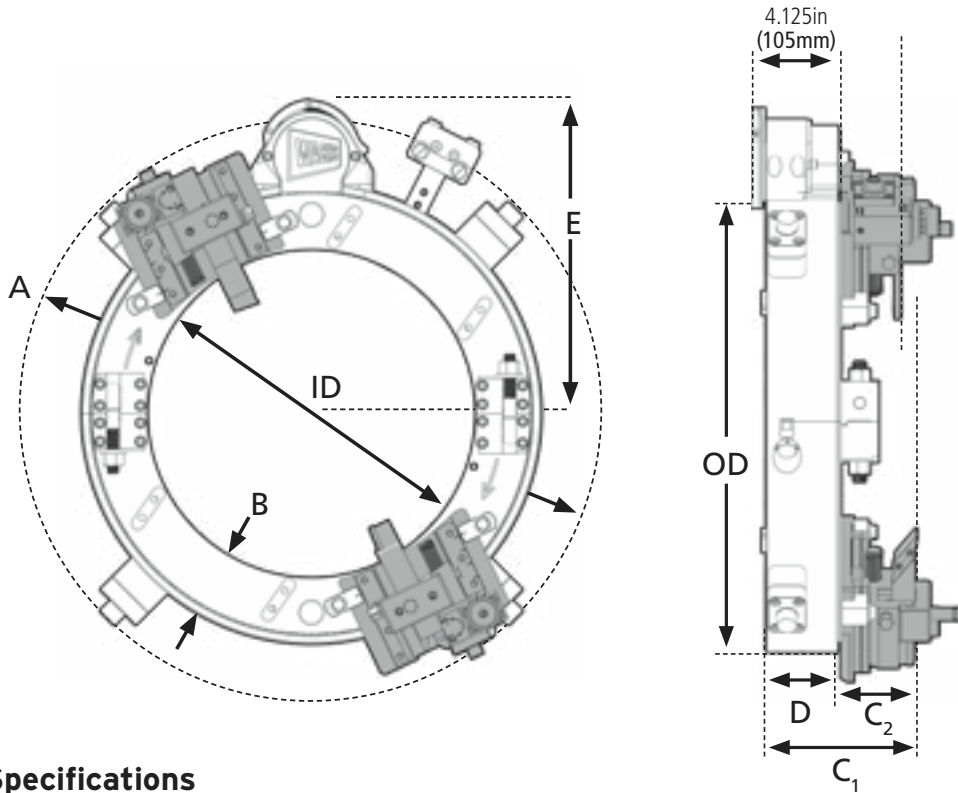

Dimensional Specifications

MODEL	ID	OD	A ROTATING PARTS DIAMETER			B FRAME THICKNESS	MDSF TOOLING		LEGACY TOOLING		D FRAME DEPTH	E PINION RADIUS STANDARD	PRODUCT WEIGHT		
			1.5IN SLIDES	2.5IN SLIDES	3.5IN SLIDES		C ₁ CUT LINE TO REAR	C ₂ CUT LINE TO FRONT	C ₁ CUT LINE TO REAR	C ₂ CUT LINE TO FRONT			HALF RING	FULL RING	RING & 2.5IN SLIDES
206	7.25in (184mm)	12.65in (321mm)	17.86in (454mm)	20.2in (513mm)		2.7in (69mm)						9.49in (241mm)	28lb (12.7kg)	54.5lb (24.7kg)	74.9lb (34kg)
408	9.25in (235mm)	14.53in (369mm)	19.8in (503mm)	22.16in (563mm)		2.64in (67mm)						10.49in (266.4mm)	31lb (14.1kg)	57.5lb (26.1kg)	77.9lb (35.3kg)
610	11.25in (286mm)	16.5in (419mm)	21.76in (553mm)	24.12in (613mm)								11.49in (291.8mm)	37lb (16.8kg)	70lb (31.8kg)	90.4lb (41kg)
612	13.25in (337mm)	18.5in (470mm)	23.74in (603mm)	26.1in (663mm)	32.04in (814mm)	2.625in (67mm)						12.49in (317.2mm)	41lb (18.6kg)	77lb (34.9kg)	97.4lb (44.2kg)
814	14.65in (372mm)	19.9in (506mm)	25.16in (639mm)	27.54in (700mm)	33.48in (850mm)		5.375in (136.5mm)		5.125in (130.2mm)		3in (76.2mm)	13.19in (335mm)	44lb (20kg)	81lb (36.7kg)	101.4lb (46kg)
1016	16.65in (423mm)	21.95in (558mm)	27.22in (691mm)	29.6in (752mm)	35.54in (903mm)							14.19in (360.4mm)	47lb (21.3kg)	88lb (39.9kg)	108.4lb (49.2kg)
1218	18.65in (474mm)	23.95in (608mm)	29.28in (744mm)	31.66in (804mm)	37.6in (955mm)	2.65in (67mm)						15.19in (385.8mm)	52lb (23.6kg)	97lb (44kg)	117.4lb (53.3kg)
1420	20.65in (525mm)	25.95in (659mm)	31.3in (795mm)	33.68in (856mm)	39.64in (1007mm)		2.375in (60mm)		2.125in (54mm)			16.19in (411.2mm)	54lb (24.5kg)	103lb (46.7kg)	123.4lb (56kg)
1824	25.05in (636mm)	30.35in (771mm)	30.35in (771mm)	38.16in (969mm)	44.14in (1121mm)							18.39in (467.1mm)	60.5lb (27.4kg)	116.5lb (52.8kg)	136.9lb (62.1kg)
2228	29.05in (738mm)	35.55in (903mm)	39.94in (1015mm)	42.32in (1075mm)	48.3in (1227mm)							20.99in (533.1mm)	92lb (41.7kg)	174.5lb (79.2kg)	194.9lb (88.4kg)
2632	33.05in (840mm)	39.55in (1005mm)	43.92in (1116mm)	46.3in (1176mm)	52.28in (1328mm)							22.99in (583.9mm)	101lb (45.8kg)	191.5lb (86.9kg)	211.9lb (96.1kg)
3036	37.65in (956mm)	44.15in (1121mm)	48.56in (1233mm)	50.94in (1294mm)	56.94in (1446mm)	3.25in (83mm)						25.29in (642.4mm)	115lb (52.2kg)	218lb (98.9kg)	238.4lb (108.1kg)
3642	43.65in (1109mm)	50.15in (1274mm)	54.54in (1385mm)	56.94in (1446mm)	62.92in (1598mm)		5.625in (142.9mm)		5.375in (136.5mm)		3.25in (82.6mm)	28.29in (718.6mm)	127lb (57.6kg)	246lb (111.6kg)	266.4lb (120.8kg)
4248	49.65in (1261mm)	56.15in (1426mm)	60.52in (1537mm)	62.92in (1598mm)	68.9in (1750mm)							31.29in (794.8mm)	139.5lb (63.3kg)	271lb (122.9kg)	291.4lb (132.2kg)
4854	56.05in (1424mm)	63.75in (1619mm)	66.9in (1699mm)	69.3in (1760mm)	75.3in (1913mm)							34.99in (888.7mm)	174lb (78.9kg)	344lb (156kg)	364.4lb (165.3kg)
5460	62.05in (1576mm)	69.75in (1772mm)	72.9in (1852mm)	75.3in (1913mm)	81.28in (2065mm)	3.85in (98mm)						38.99in (990.3mm)	190lb (86.2kg)	375lb (170.1kg)	395.4lb (179.4kg)

DynaPrep MDSF Specifications

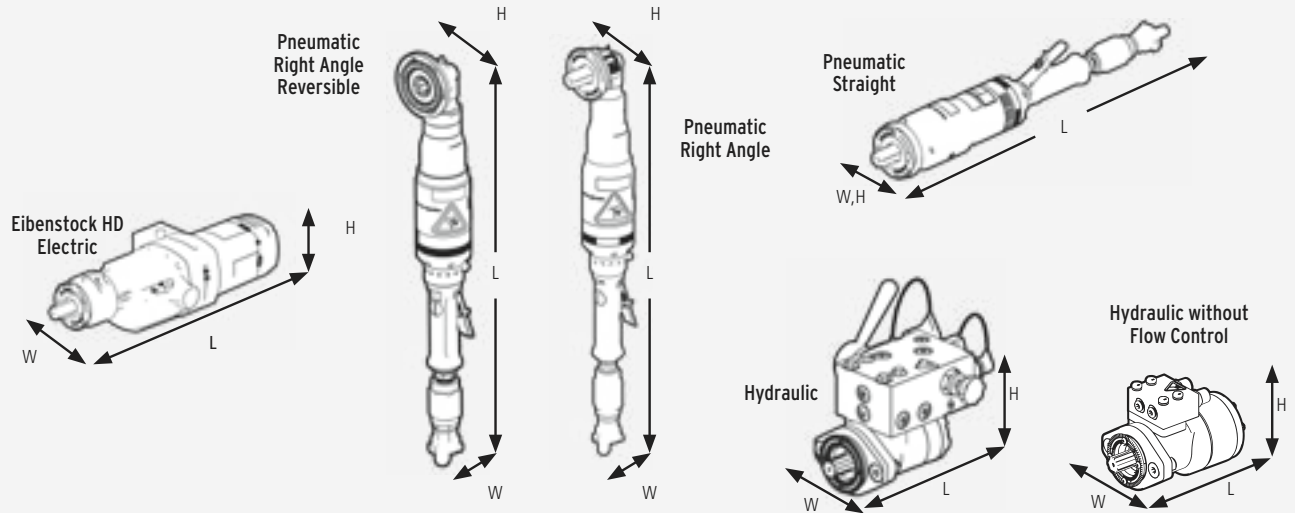

MODEL	(L) LENGTH	(W) WIDTH	(H) HEIGHT
Eibenstock HD Electric	18.7in (475mm)	10in (254mm)	6.2in (157mm)
Pneumatic Right Angle	24in (609mm)	3.23in (82mm)	3.29in (84mm)
Pneumatic Straight	22.32in (567mm)	3.5in (89mm)	3.5in (89mm)
Pneumatic Right Angle Reversible	25.89in (658mm)	3.84in (98mm)	3.29in (84mm)
Hydraulic Drive with Flow Control	10.87in (276mm)	7.96in (202.3mm)	6.98in (177mm)
Hydraulic Drive without Flow Control	8.83in (224mm)	5.27in (134mm)	5.87in (148mm)
ACM Air Control Module with Remote Control	24.5in (622mm)	16.0in (406mm)	16.5in (419mm)
D-23 Diesel Hydraulic Power Unit	39in (99cm)	29in (73.7cm)	36.5in (93cm)
HPU 20 Electric Hydraulic Power Unit	46.5in (104cm)	21in (53.3cm)	28in (71cm)

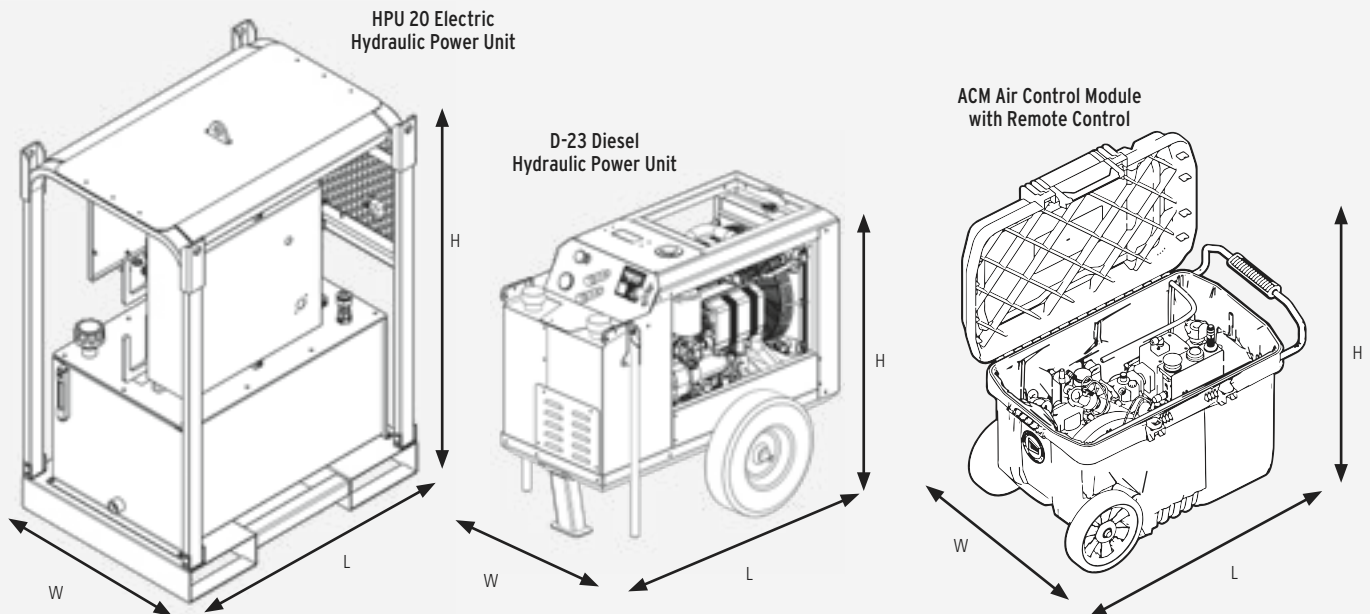

DynaPrep MDSF Base Kits

Simplified Ordering

The DynaPrep MDSF Base Kit includes most commonly specified components, just add a drive motor and tooling. Less expensive and easier than ordering components ala carte, these base model MDSF Kits are ideal where multiple ring sizes are required onsite. Highly upgradeable, these kits feature 1.5in stroke tool slides on sizes up to 10in, 2.5in stroke tool slides on sizes up to 48in, and 3.5in stroke tool slides on the larger ring sizes. All machines in this group offer a large range of optional tool slides.

All E.H. Wachs drives feature our tool-less quick mount system with positive face gear engagement. As part of a complete machining system, the modular design of the MDSF allows different modules to extend its capabilities to include multiple applications such as flange facing, casing cutting, trepanning, and deep counterboring. Like all E.H. Wachs split frames it comes complete with a heavy duty storage case to protect your machine tool investment.

Each Kit Includes

- Rotating Ring & Drive Pinion Set
- Tool Slide sets:
 - Rapid Adjust 1.5in Stroke (2-10in)
 - Rapid Adjust 2.5in Stroke (12-48in)
 - Rapid Adjust 3.5in Stroke (54-72in)
- Indexing Trip Assembly
- Spare Fastener Kit
- Operating Hand Tools
- Storage Case
- Operating Manual



DynaPrep MDSF Kit with pneumatic straight drive motor



Base Kits come complete, just add drive motor and tooling



DynaPrep MDSF Kit in standard shipping / storage case

MDSF BASE KITS	OPERATING RANGE	CLAMPING RANGE	OPERATING WEIGHT	PART #
Model 206	2-6in (51-152mm)	1.36-7.21in (35-183mm)	54.5 lb (24.7 kg)	69-5400-06
Model 408	4-8in (102-203mm)	1.67-9.21in (42-234mm)	57.5 lb (26.1 kg)	69-5400-08
Model 610	6-10in (152-254mm)	3.63-11.20in (92-284mm)	70 lb (31.8 kg)	69-5400-10
Model 612	6-12in (152-305mm)	5.6-13.2in (142-335mm)	77 lb (34.9 kg)	69-5400-12
Model 814	8-14in (203-356mm)	7-14.59in (178-371mm)	81 lb (36.7 kg)	69-5400-14
Model 1016	10-16in (254-406mm)	9-16.59in (229-421mm)	88 lb (40 kg)	69-5400-16
Model 1218	12-18in (305-457mm)	10.99-18.59in (279-472mm)	97 lb (44 kg)	69-5400-18
Model 1420	14-20in (356-508mm)	12.99-20.59in (330-523mm)	103 lb (46.7 kg)	69-5400-20
Model 1824	18-24in (457-610mm)	17.39-24.99in (442-635mm)	116 lb (52.8 kg)	69-5400-24
Model 2228	22-28in (559-711mm)	21.4-29in (544-737mm)	174.5 lb (79.2 kg)	69-5400-28
Model 2632	26-32in (660-813mm)	25.4-32.99in (645-838mm)	191.5 lb (86.9 kg)	69-5400-32
Model 3036	30-36in (762-914mm)	29.99-37.59in (762-955mm)	218 lb (98.9 kg)	69-5400-36
Model 3642	36-42in (914-1067mm)	35.99-43.59in (914-1107mm)	246 lb (111.6 kg)	69-5400-42
Model 4248	42-48in (1067-1219mm)	41.99-49.59in (1067-1260mm)	271 lb (122.9 kg)	69-5400-48
Model 4854	48-54in (1219-1372mm)	40.39-55.99in (1026-1422mm)	344 lb (156 kg)	69-5400-54
Model 5460	54-60in (1372-1524mm)	46.39-61.99in (1178-1575mm)	375 lb (170.1 kg)	69-5400-60
Model 6066*	60-66in (1524-1676mm)	CALL	CALL	69-5400-66
Model 6672*	66-72in (1676-1829mm)	CALL	CALL	69-5400-72

*CALL FOR AVAILABILITY

DynaPrep MDSF Pipeline Base Kits

Pipeline Base Kits

DynaPrep MDSF Pipeline Base Kits are configured with the components typically specified in pipeline MRO operations. Large diameter thin wall pipe used in pipelines tend to be out-of-round, which makes precision weld preps with standard tool slides problematic. Wachs included out-of-round spring tool slides track the outside of the pipe to maintain a perfect land and prep. These slides allow a 12in operating range.

These kits are complete, just add a drive motor and tooling. They are perfect for most pipeline applications, with an optional right angle drive available. Like all DynaPrep MDSF machines, their modular design means a machine configured for pipeline projects can be reconfigured for multiple applications, including deep counterboring and flange facing, making them highly versatile machines. These and all DynaPrep machines and accessories are available for purchase or rental at a regional Sales, Service and Rental Center near you.

Each Kit Includes

- Rotating Ring & Drive Pinion Set
- OD Tracking Tool Slide Set
- Manual Trip Assembly
- Extended Reach Reinforcement Legs (INCLUDED WITH SOME RING SIZES.)
- Spare Fastener Kit
- Operating Hand Tools
- Storage Case
- Operating Manual

MDSF PIPELINE BASE KITS	OPERATING RANGE	CLAMPING RANGE	OPERATING WEIGHT	PART #
Model 612	6-12in (152-305mm)	5.6-13.2in (142-335mm)	77 lb (34.9 kg)	69-5405-12
Model 814	8-14in (203-356mm)	7-14.59in (178-371mm)	81 lb (36.7 kg)	69-5405-14
Model 1016	10-16in (254-406mm)	9-16.59in (229-421mm)	88 lb (40 kg)	69-5405-16
Model 1218	12-18in (305-457mm)	10.99-18.59in (279-472mm)	97 lb (44 kg)	69-5405-18
Model 1420	14-20in (356-508mm)	12.99-20.59in (330-523mm)	103 lb (46.7 kg)	69-5405-20
Model 1824	18-24in (457-610mm)	17.39-24.99in (442-635mm)	116 lb (52.8 kg)	69-5410-24
Model 2228	22-28in (559-711mm)	21.4-29in (544-737mm)	174.5 lb (79.2 kg)	69-5410-28
Model 2632	26-32in (660-813mm)	25.4-32.99in (645-838mm)	191.5 lb (86.9 kg)	69-5410-32
Model 3036	30-36in (762-914mm)	29.99-37.59in (762-955mm)	218 lb (98.9 kg)	69-5410-36
Model 3642	36-42in (914-1067mm)	35.99-43.59in (914-1107mm)	246 lb (111.6 kg)	69-5410-42
Model 4248	42-48in (1067-1219mm)	41.99-49.59in (1067-1260mm)	271 lb (122.9 kg)	69-5410-48
Model 4854	48-54in (1219-1372mm)	40.39-55.99in (1026-1422mm)	344 lb (156 kg)	69-5410-54
Model 5460	54-60in (1372-1524mm)	46.39-61.99in (1178-1575mm)	375 lb (170.1 kg)	69-5410-60
Model 6066*	60-66in (1524-1676mm)	CALL	CALL	69-5410-66
Model 6672*	66-72in (1676-1829mm)	CALL	CALL	69-5410-72

* CALL FOR AVAILABILITY.



DynaPrep MDSF Pipeline are specially configured for MRO on thin wall, large diameter pipe



Available in sizes for 6-72in (152-1829mm) pipe



OD tracking slides follow out-of-round pipe & vessels.

DynaPrep MDSF Flange Facing

FFC Flange Facing Cantilever Module

E.H. Wachs new FFC flange facing is ideal where an MDSF is already onsite for pipe cutting and beveling. This kit adds counterboring capabilities and advanced flange facing and record grooving capabilities without the need for heavy and expensive dedicated facers.

The FFC module is used on flat face, raised face and applications where the FFR rail will not work, such as heat exchangers. It will machine 500 RMS, 250 RMS, 125 RMS and 63 RMS record groove finishes, plus machining of the smooth bolt face finish. Setting up the DynaPrep for flange facing is fast and easy with its new patent pending Axially Adjustable Legs featuring removable guides to quickly square the machine to the bolt face. Two FFC modules will simultaneously machine multiple surfaces in a single pass (as shown).

Specifications

- FFC uses the DynaPrep MDSF as the machining platform
- Radial auto feed crashproof starwheel
- Radial feed rate in inches per revolution .003-.048in
- Axial feed rate in inches per revolution manually variable .001-.025in with 2in of axial travel
- Optional remote trip actuation

FFC Kit Includes

- FFC module
- MDSF heavy wall tool slide
- Counterweight & holder
- Two trips
- Trip extensions
- Axial adjustable legs
- Magnetic base dial indicator set
- Complete starter tooling kit
- Heavy duty storage case
- Optional remote trip actuation

FRAME SIZE	MOUNTING Ø MAX	MOUNTING Ø MIN	ID REACH FFC	PART #
6-12in (152-305mm)	10.7in (272mm)	3.3in (84mm)	Full Reach	69-5260-00
8-14in (203-356mm)	11.9in (302mm)	4.6in (117mm)	Full Reach	
10-16in (254-406mm)	13.9in (353mm)	6.6in (168mm)	Full Reach	
14-20in (356-508mm)	17.9in (455mm)	10.6in (269mm)	Full Reach	
18-24in (457-610mm)	22.2in (564mm)	15.1in (384mm)	Full Reach	
22-28in (559-711mm)	26.2in (665mm)	19.1in (485mm)	13.6in (345mm)	
26-32in (660-813mm)	30.2in (767mm)	23.1in (587mm)	13.6in (345mm)	
30-36in (762-914mm)	34.4in (874mm)	27.6in (701mm)	13.6in (345mm)	
36-42in (914-1067mm)	40.4in (1026mm)	33.6in (853mm)	13.6in (345mm)	
42-48in (1067-1219mm)	46.4in (1179mm)	39.6in (1006mm)	13.6in (345mm)	
48-54in (1219-1372mm)	52.4in (1331mm)	45.6in (1158mm)	13in (330mm)	
54-60in (1372-1524mm)	58.4in (1483mm)	51.6in (1311mm)	13in (330mm)	
60-66in (1524-1676mm)	64.4in (1636mm)	57.6in (1463mm)	13in (330mm)	
66-72in (1676-1829mm)	70.4in (1788mm)	63.6in (1615mm)	13in (330mm)	



FFC Flange Facing Cantilever Module



FFC reaches up to 13.6in (345mm) in certain configurations.



Compact, the FFC can face flanges in any position or orientation



Two FFC modules simultaneously machine bolt face & record groove

DynaPrep MDSF Flange Facing

FFR Flange Facing Rail Module

The FFR module for flat face, raised face, and RTJ grooved flanges, machines 500 RMS, 250 RMS, 125 RMS and 63 RMS record groove finishes, plus it can machine the smooth bolt face finish and counterbore. The rail module is also adjustable in multiple axes to machine RTJ ring grooves.

Setting up the DynaPrep for FF flange facing is fast and easy with axially adjustable legs that feature removable guides to quickly square the machine to the bolt face. A single FFR module can machine the bolt face and record groove in two operations, or optionally two modules can be used to simultaneously machine multiple surfaces in a single pass (as shown) or machine RTJ grooves.

Specifications

- Uses the DynaPrep MDSF as the machining platform
- Full range machining from 0-72in (module specific)
- Radial feed rate inches per revolution .003-.048in
- Radial auto feed crashproof starwheel
- Radial travel 3.5-72in; kit dependent
- Axial feed rate in inches per revolution manually variable .001-.025in with 2in of axial travel
- Optional auto axial feed and remote trip actuation

FFR Kit Includes

- FFR module
- MDSF heavy wall tool slide
- MDSF slave slide
- FFR rail mounts
- 2 additional trips with trip extensions
- Axial adjustable legs
- Magnetic base dial indicator set
- Complete starter tooling kit
- Heavy duty storage cases

FRAME SIZE	MOUNTING Ø MAX	MOUNTING Ø MIN	ID REACH FFR	PART #
6-12in (152-305mm)	10.7in (272mm)	3.3in (84mm)	Full Reach	69-5270-16
8-14in (203-356mm)	11.9in (302mm)	4.6in (117mm)	Full Reach	
10-16in (254-406mm)	13.9in (353mm)	6.6in (168mm)	Full Reach	
14-20in (356-508mm)	17.9in (455mm)	10.6in (269mm)	Full Reach	69-5270-20
18-24in (457-610mm)	22.2in (564mm)	15.1in (384mm)	Full Reach	69-5270-28
22-28in (559-711mm)	26.2in (665mm)	19.1in (485mm)	Full Reach	
26-32in (660-813mm)	30.2in (767mm)	23.1in (587mm)	Full Reach	69-5270-36
30-36in (762-914mm)	34.4in (874mm)	27.6in (701mm)	Full Reach	
36-42in (914-1067mm)	40.4in (1026mm)	33.6in (853mm)	Full Reach	69-5270-48
42-48in (1067-1219mm)	46.4in (1179mm)	39.6in (1006mm)	Full Reach	
48-54in (1219-1372mm)	52.4in (1331mm)	45.6in (1158mm)	Full Reach	69-5270-60
54-60in (1372-1524mm)	58.4in (1483mm)	51.6in (1311mm)	Full Reach	
60-66in (1524-1676mm)	64.4in (1636mm)	57.6in (1463mm)	Full Reach	69-5270-72
66-72in (1676-1829mm)	70.4in (1788mm)	63.6in (1615mm)	Full Reach	



FFR Flange Facing Rail Module



Modules are clearly marked to indicate depth and prep angle



FFR tooling can be adjusted on multiple axes



Two FFR modules performing simultaneous operations

DynaPrep MDSF Accessories

DynaPrep MDSF Drive Motors

Wachs offers a wide range of pneumatic, hydraulic and electric drive motor options, offering the power and durability required to drive the MDSF to its full form tooling potential.

DESCRIPTION	PART #
Pneumatic Right Angle Drive Motor w/Speed Control, Chicago Fitting, and ACM Air Control Module	69-5454-00
Pneumatic Right Angle Drive Motor w/Control Handle, Speed Control, Chicago Fitting, and ATM Air Treatment Module	69-5452-00
Pneumatic Right Angle Drive Motor w/Control Handle, Speed Control, Oiler, Filter, and Chicago Fitting	69-5450-00
Pneumatic Straight Drive Motor w/Speed Control, Chicago Fitting, and ACM Air Control Module	69-5455-00
Pneumatic Straight Drive Motor w/Control Handle, Speed Control, Chicago Fitting, and ATM Air Treatment Module	69-5453-00
Pneumatic Straight Drive Motor w/Control Handle, Speed Control, Oiler, Filter, and Chicago Fitting	69-5451-00
Right Angle Adapter for Pneumatic Straight Drive Motors	69-4359-00
Pneumatic Reversible Right Angle Drive Motor w/Handle	69-4353-01
Universal Hydraulic Drive Motor with Flow control	69-4358-00
Universal Hydraulic Drive Motor without Flow Control	69-4363-01
Eibenstock HD Electric Drive-110V, MDSF	69-4340-00
Eibenstock HD Electric Drive-220V, MDSF	69-4341-00
Eibenstock HD Electric Drive-110V w/remote pendant (requires controller)	69-4342-00
Eibenstock HD Electric Drive-220V w/remote pendant (requires controller)	69-4343-00
Eibenstock HD 110v w/remote pendant, electric remote trip, controller	69-4344-00
Eibenstock HD 220v w/remote pendant, electric remote trip, controller	69-4345-00
Eibenstock Drill-style Electric Drive Assembly-110V	SPG-489-4110
Eibenstock Drill-style Electric Drive Assembly-220V	SPG-489-4220



Multiple drive options are available for DynaPrep MDSF



DynaPrep MDSF Tool-Free 6B Spline Drive Pinion

DynaPrep MDSF Pinion Drive

Advanced heavy duty 6B splined pinion drives are responsible for applying power with their stronger, heat treated gear sets.

DESCRIPTION	MOUNT	PART #
1/2in Female to 6b Spline Male Adapter	1/2in (12.7mm) Square	69-3037-00
Spline Drive Pinion Standard (Tool Free)	6B Spline	69-4484-00
Spline Drive Pinion Front Drive (Tool Free)		69-4481-01



Dual pin trip design eliminates starwheel timing

DynaPrep MDSF Trip Feed

Advanced dual pin design that eliminates the need to time the starwheel prevents crashes and is engineered to accommodate optional pneumatic and electric powered remote trip control.

DESCRIPTION	PART #
Manual Trip (Post sold separately)	69-3018-00
Pneumatic Trip (Post sold separately)	69-4741-00
Electric Trip (Post sold separately)	69-3084-00
Trip Bar/Post Positioning 6-24in (For 1.5in and 2.5in slides)	69-0071-00
Trip Bar/Post Positioning 28-60in (For 1.5in and 2.5in slides)	69-0232-00
Trip extension Adapter for (3.50in slide assembly)	69-3019-00
Trip Assembly, OD Tracking 12-60in	69-4744-01
Dual Trip Assembly. Required when Flange Facing with Bridge Slide	69-3046-00



Pneumatic Trip assembly for remote operation

DynaPrep MDSF Accessories

DynaPrep MDSF Tool Slide Options

Groundbreaking design with multiple features including Rapid Adjust & Micro Adjust tool depth, MDSF tool slides are available in standard and high feed models plus dedicated standard and deep counterboring slides.

DESCRIPTION	INCLUDES	PART #
Low Clearance Cutting & Beveling Worm Slide Kit* .003in Feed & 1.5in Stroke	(2) 69-4615-03 Slides Double Bevel Cover	69-5215-03
Standard Cutting & Beveling Worm Slide Kit* .003in Feed & 2.5in Stroke	(2) 69-4625-03 Slides Double Bevel Cover	69-5225-03
Extended Cutting & Beveling Worm Slide Kit* .003in Feed & 3.5in Stroke.	69-3019-00 trip extension (2) 69-4655-03 Slides Double Bevel Cover	69-5255-03
Low Clearance Cutting & Beveling Worm Slide Kit* .006in Feed & 1.5in Stroke.	(2) 69-4615-06 Slides Double Bevel Cover	69-5215-06
Standard Cutting & Beveling Worm Slide Kit* .006in Feed & 2.5in Stroke	(2) 69-4625-06 Slides Double Bevel Cover	69-5225-06
Extended Cutting & Beveling Worm Slide Kit* .006in Feed & 3.5in Stroke	69-3019-00 trip extension (2) 69-4655-06 Slides Double Bevel Cover	69-5255-06
OD Tracking Slide Kit 12-60in	(2) 69-4604-02 Slides (1) 69-4744-01 Spring Trip 54-60in Extension Leg Sets Storage Case, Toe Clamps, Hand Tools	69-5204-01
Deep Counter Bore Slide Assembly. 3in Depth.		69-4605-00
Deep Counter Bore Slide Assembly. 6in Depth.		69-4606-00
Heavy Wall Parting Slide Kit .003in Feed & 3.50in Stroke	Parting Slide & Trip Adapter	69-5235-03
Heavy Wall Parting Slide Kit .006in Feed & 3.50in Stroke	Parting Slide & Trip Adapter	69-5235-06

*TRIP NOT INCLUDED

DynaPrep MDSF Miscellaneous Accessories

Perform casing cutting and more with the line of DynaPrep MDSF Accessories.

DESCRIPTION	PART #
Axial Adjustment Legs with Removable Shoulders	69-4807-00
Casing Cutter, Internal/External 7-13in	69-4810-00
Dial Indicator Set	69-3082-00
Button Leg Pad Set	69-4802-00
Extension Leg Assembly (Single Leg)	69-4800-00
Extension Leg Assembly, 54-60in (Single Leg)	69-4801-00

Air Treatment & Air Control Modules

ATM Air Treatment Modules condition and regulate the incoming air to extend motor life. ACM Air Control Module adds remote control capability plus air treatment.

DESCRIPTION	PART #
ATM Air Treatment Module with Shipping Case (non-CE compliant) SUPERSEDES P/N (26-407-00). REQUIRED FOR USE WITH "CONTROL HANDLE" AIR MOTORS ONLY.	69-4102-01
ACM Air Control Module & Remote Trip Kit (CE Compliant) REQUIRED FOR "NO CONTROL HANDLE" AIR MOTORS	69-4100-00
ACM Air Control Remote REQUIRED FOR USE WITH "NO CONTROL HANDLE" AIR MOTORS	69-4101-01

DynaPrep MDSF Pneumatic Meter-Out Kits

Controls (meter) the exhaust (out) flow to yield higher torque, low rpm operation. Used where extra torque and precise speed control at slow speeds is required. Includes exhaust manifold, speed control and muffler.

DESCRIPTION	PART #
Meter-Out Adapter Kit	69-4366-00



DynaPrep MDSF 2.5in Stroke Slide



DynaPrep MDSF OD Tracking Slide for out-of-round pipe



ACM Air Treatment & Remote Control Module



Meter-Out Adapter Kit

DynaPrep MDSF Accessories

DynaPrep MDSF Modules & Templates

For single point beveling applications, counterboring, and flange facing.
(MDSF requires 69-5300-00 Adapter)

DESCRIPTION	PART #
PrecisePrep Tool Slide for Single Pointing and Heavy Wall Counterbore	CALL
Bridge Slide for SF 612, SF 814*	60-428-14
Bridge Slide for SF 612, SF 814, SF 1016*	60-428-16
Bridge Slide for SF 612, SF 814, SF 1016, SF 1218, SF 1420*	60-428-20
Bridge Slide for SF 1218, SF 1420, SF 1824*	60-428-24
Bridge Slide for SF 1824, SF 2228*	60-428-28
Bridge Slide for SF 2228, SF 2632*	60-428-32
Bridge Slide for SF 2632, SF 3036*	60-428-36
Bridge Slide for SF 3642*	60-428-42
Bridge Slide for SF 3642, SF 4248*	60-428-48
MDSF Bridge Slide Adapter Kit	69-5300-00
37.5° Bridge Slide Template	53-409-02
30° Bridge Slide Template	53-409-03
20° Bridge Slide Template	53-409-05
10° X 37.5° Bridge Slide Template	53-409-11
10° X 30° Bridge Slide Template	53-409-12
10° X 20° Bridge Slide Template	53-409-13

*REQUIRES MDSF ADAPTER KIT, ORDERED SEPARATELY.

DynaPrep MDSF Tooling

DESCRIPTION	PART #
HSS Standard 3/8 x 3/8in Tool Bit for Single Point Facing, Beveling, Socket Weld Removal & Flange Facing. For use with SDB 206/412, EP 424, FF, SWR & SDSF Machines. (2-PIECE MINIMUM ORDER)	52-701-01
Premium coated HSS 3/8 x 3/8in Tool Bit for Single Point Facing, Beveling, Socket Weld Removal & Flange Facing. For use with SDB 206/412, EP 424, FF, SWR & SDSF Machines. (2-PIECE MINIMUM ORDER)	52-701-01P
Single Point Tool Holder Kit for Facing & Beveling. UTILIZES P/N 81-701-XX HSS & 81-703-XX CARBIDE TOOL INSERTS	60-718-00
Single Point Tool Insert (HSS)	81-701-01
Single Point Tool Insert, 10-Pack (HSS)	81-701-10
Single Point Tool Insert (Carbide)	81-703-01
Single Point Tool Insert, 10-Pack (Carbide)	81-703-10
Premium Coated Single Point Tool Insert (HSS)	81-701-00P
Premium Coated Single Point Tool Insert, 10-Pack (Coated HSS)	81-701-10P
HSS 4:1 Taper Counterbore Tool; also for use with EP 424 machines. (2-PIECE MINIMUM ORDER)	60-700-04
HSS .094in (3/32in) Radiusing "J" Tool Insert for J-Prep	81-704-01
HSS .125in (1/8in) Radiusing "J" Tool Insert for J-Prep	81-705-01
HSS .188in (3/16in) Radiusing "J" Tool Insert for J-Prep	81-706-01
HSS 6mm Radiusing "J" Tool Insert for J-Prep	81-707-01



PrecisePrep Heavy Wall Slide



Bridge Slide with Adapter Kit for MDSF



Single Point Tooling
available in 10 packs



HSS DuoEdge Single Point
Tooling Insert

DynaPrep MDSF Tooling

DynaPrep MDSF Tooling

HSS blades, carbide tool insert holders & carbide inserts for straight cut-off

DESCRIPTION		PART #
HSS 3/16in Wide Parting Blade (3- 7/16in Long)		43-711-00
HSS 3/16in Wide Parting Blade (5in Long)		43-711-01
HSS 3/16in Wide Parting Blade (5in Long, T-15)		69-7111-01
HSS 1/4in Wide Parting Blade (6in Long)		60-711-00
HSS 1/4in Wide Parting Blade (6in Long, T-15)		69-7111-00
3/16in Carbide Parting Tool Kit	Holder, Extractor, (1) 60-717-00 Tool Insert	60-716-00
3/16in Carbide Tool Insert for Parting		60-717-00
1/4in Carbide Parting Tool Kit	Holder, Extractor, (1) 60-715-00 Tool Insert	60-714-00
1/4in Carbide Tool Insert for Parting		60-715-00
Heavy Wall Carbide Insert Tooling Kit	Holder, Extractor, (1) (60-713-00) .313in Insert	60-712-00
Carbide Cutting Tool Insert, .313in wide USED WITH 60-712-00 TOOL INSERT HOLDER KIT. (2-PIECE MINIMUM ORDER)		60-713-00
.314 Heavy Wall Carbide Tooling Kit.	10in Holder (69-7012-01), .314in wide Tool Insert (69-7013-00), & Extractor (60-712-02)	69-7012-00
Tool Insert, .314 Wide		69-7013-00
Tool Insert, 10-Pack .314 Wide Heavy Wall		69-7013-10
.374 Heavy Wall Carbide Tooling Kit	10in Holder (69-7012-01), .374in wide Tool Insert (69-7014-00), & Extractor (60-712-02)	69-7112-00
Tool Insert, .374 Wide		69-7014-00
Tool Insert, 10-Pack .374 Wide Heavy Wall		69-7014-10
DuoEdge HSS Tool Insert 10-Pack		81-701-10
DuoEdge Carbide Tool Insert 10-Pack		81-703-10
DuoEdge Triple Point Tool Insert		56-710-00

CONSULT THE FACTORY FOR OTHER APPLICATIONS OR CUSTOM TOOLING.

Bevel, Counterbore & Flange Facing Tooling Kits

(Each kit includes insert holder, insert screws, wrench, & storage container)

DESCRIPTION	PART #
Tool Holder Kit, 37.5° Inside Bevel	69-7000-00
Tool Holder Kit, 37.5° Outside Bevel	69-7001-00
Tool Holder Kit, 30° Inside Bevel	69-7019-00
Tool Holder Kit, 30° Outside Bevel	69-7029-00
Tool Holder Kit, 10 x 37.5° Compound Inside Bevel UTILIZES 69-7008-02 TOOL INSERT	69-7008-01
Tool Holder Kit, 10 x 37.5° Compound Outside Bevel UTILIZES 69-7009-02 TOOL INSERT	69-7009-01
Tool Holder Kit, 10-30° Compound Inside Bevel	69-7020-01
Tool Holder Kit, 4:1 Taper Counterbore UTILIZES 81-701-XX HSS & 81-703-XX CARBIDE TOOL INSERTS	69-7007-00
Tool Holder Kit, 30° Single Point Counterbore UTILIZES 81-701-XX HSS & 81-703-XX CARBIDE TOOL INSERTS	69-7007-01
Single Point Tool Holder Kit for Facing & Beveling UTILIZES P/N 81-701-XX HSS & 81-703-XX CARBIDE TOOL INSERTS	60-718-00
Tool Holder Kit, Flange Facing. UTILIZES 56-710-00 TOOL INSERT	69-7010-00
Tool Holder Kit, Counterbore.	60-708-00
DuoEdge J-prep Bevel Tool Insert	81-707-01



HSS 1/4in Wide Parting Blade



DuoEdge 30° Inside Bevel
Tool Holder & Tool

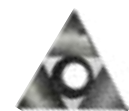

DuoEdge Triple Point Insert



DuoEdge 37.5° Outside Bevel
Tool Holder & Tool

Bevel, Counterbore & Flange Facing Inserts

DESCRIPTION	PART #
Tool Insert for 30 & 37.5° Inside Bevel	69-7006-00
Tool Insert for 30 & 37.5° Outside Bevel	69-7011-00
Tool Insert for 10 x 37.5° Inside Compound Bevel	69-7008-02
Tool Insert for 10 x 37.5° Outside Compound Bevel	69-7009-02
Tool Insert, 10° x 30° Inside Comp. Bevel	69-7020-00
Single Point Tool Insert (HSS)	81-701-01
Single Point Tool Insert, 10-Pack (HSS)	81-701-10
Premium Coated Single Point Tool Insert (HSS)	81-701-00P
Premium Coated Single Point Tool Insert, 10-Pack (Coated HSS)	81-701-10P
Single Point Tool Insert (Carbide)	81-703-01
Single Point Tool Insert, 10-Pack (Carbide)	81-703-10
HSS .094in (3/32in) RADIUSING "J" TOOL INSERT	81-704-01
HSS .125in (1/8in) RADIUSING "J" TOOL INSERT	81-705-01
HSS .188in (3/16in) RADIUSING "J" TOOL INSERT	81-706-01
HSS 6mm RADIUSING "J" TOOL INSERT	81-707-01
HSS TOOL INSERT FOR FLANGE FACING (3 CUTTING TIPS, HIGH AND LOW RANGE)	56-710-00

CONSULT THE FACTORY FOR OTHER APPLICATIONS OR CUSTOM TOOLING.

DynaPrep MDSF Single Bevel Form Tools

DESCRIPTION	PART #
HSS 37.5° Inside Bevel Tool (3 1/8in long)	43-703-05
HSS 37.5° Outside Bevel Tool (3 1/8in long)	43-708-05
HSS 37.5° Double Bevel Tool (3 1/8in long)	43-710-05
HSS 37.5° Inside Bevel Tool (5in long)	53-703-00
HSS 37.5° Inside Bevel Tool (5in long), Premium Coated	53-703-00P
HSS 37.5° Outside Bevel Tool (5in long)	43-708-06
HSS 37.5° Double Bevel Tool (5in Long)	43-710-06
HSS 30° Inside Bevel Tool (3 1/8in long)	43-702-05
HSS 30° Outside Bevel Tool (3 1/8in long)	43-707-05
HSS 30° Double Bevel Tool (3 1/8in long)	43-709-05
HSS 30° Inside Bevel Tool (5in long)	53-703-01
HSS 30° Inside Bevel Tool (5in long). Premium Coated	53-703-01P
HSS 30° Outside Bevel Tool (5in long)	43-707-06
HSS 30° Double Bevel Tool (5in long)	43-709-06
HSS 45° Inside Bevel Tool (5in long)	60-719-00
HSS 45° Outside Bevel Tool (5in long)	60-720-00
HSS 60° Inside Bevel Tool (5in long)	60-719-01
HSS 60° Outside Bevel Tool (5in long)	60-720-01

DynaPrep MDSF Compound Bevel Form Tools

DESCRIPTION	PART #
HSS 10° x 37.5° Inside Bevel Tool (4in Long)	43-712-01
HSS 10° x 37.5° Outside Bevel Tool (4in Long)	43-712-02
HSS 10° x 37.5° Inside Bevel Tool, 5in long	53-705-00
HSS 10° x 30° Inside Bevel Tool, 5in long	53-704-00



DuoEdge Tooling 37.5° Outside Bevel



DuoEdge Compound Bevel Insert



DuoEdge Tooling Single Point Insert



Single Bevel Form Tool



Compound Bevel Form Tool

DynaPrep MDSF Casing Cutting

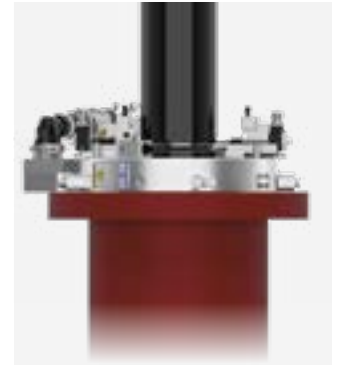

ECC simultaneously cuts and bevels casing



ECC can be inverted for cuts low to the wellhead



EICC Casing Cutter used for wellhead completion

External / Internal Casing Cutting

Wachs proven DynaPrep MDSF Split Frame technology is the base platform for our casing cutting solutions, designed to cut a wide range of casing conductors externally above the wellhead and internally below the external cut.

The ECC split frame mounts around the exposed casing OD above the wellhead and simultaneously cuts and chamfers prior to fitting the BOP. The Wachs External-Internal Casing Cutter (EICC) module kit accommodates a wide range of casing diameters above the wellhead and ID cuts with chamfering below.



ECC External Casing Cutter Kits

Precision External Cutting

Wachs ECC External Casing Cutter Kit utilizes our proven DynaPrep MDSF Split Frame technology to cut a wide range of casing conductors externally above the wellhead. The ECC split frame mounts around the exposed casing OD above the wellhead requiring minimal axial and radial clearances. It simultaneously cuts and chamfers prior to fitting the BOP. Ring sizes are available for most grades and weights of the exposed external casing (or drive pipe/conductor) up to a 14in (356mm) diameter.

The ECC takes advantage of the wide range of standard Genuine Wachs Tooling. The ECC kit includes a right angle pneumatic drive, ATM Air Treatment Module and Front Drive Pinion Housing. Remote hand held controls via the ACM Air Control Module are optionally available.

ECC kits are available in four standard ring sizes, featuring interchangeable tool slides and machine drives to cut and bevel all wellhead casing grades, sizes and weights from 4.5in to 13 3/8in OD (with larger sizes available by special order). The ECC is portable, compact, lightweight and requires minimal axial and radial clearance. A single operator can setup and machine the casing for minimal open time.

ECC External Casing Cutter Features

- External casing (drive pipe/conductor) cutting and beveling up to a 14in (356mm) diameter
- Utilizes standard Wachs Genuine Tooling for severing and chamfering
- Based on Wachs field proven DynaPrep MDSF Split Frame technology
- Requires minimal axial and radial clearances; hydraulic or pneumatic drive

Specifications

Cutting Tool Surface Speed:
60ft. per minute (18mpm)

Drive: Pneumatic

Air Requirements:
70cfm @ 80-100psi
(2cmm @ 5.6-7 Bar)

Feed Method: Starwheel feed

Feed Rate: Fixed @.0026in per
revolution (starwheel)

Standard Equipment

- DynaPrep MDSF Base Kit
- Front Mount Pinion Housing
- Right Angle Pneumatic Drive Motor
- ATM Air Treatment Module
- Fitted Storage Case
- Operating Manuals & Tools

Optional Equipment

- Extension legs
- Inverted Tool Slides
- Tooling (standard and custom)

Casing/Conductor Cutting Range Chart

CASING SIZE	SPLIT FRAME SIZE	4.5IN (114MM)	5IN (127MM)	5.5IN (140MM)	6 5/8IN (168MM)	7IN (178MM)	7 5/8IN (194MM)	8 5/8IN (219MM)	9 5/8IN (244MM)	10 3/4IN (273MM)	11 3/4IN (298MM)	13 3/8IN (340MM)	PART #
ECC MDSF 8	4-8in (102-203mm)												69-5420-08
ECC MDSF 10	6-10in (152-254mm)												69-5420-10
ECC MDSF 12	6-12in (152-305mm)												69-5420-12
ECC MDSF 14	8-14in (203-356mm)												69-5420-14



Simultaneously cuts & bevels casing



ECC can be inverted for cut lines close to the flange



ECC low clearance design fits into tight operating envelope



Dedicated DuoEdge Casing Cutting Tool Holder & Insert

EICC External / Internal Casing Cutter Kits

External / Internal Precision Cutting

Wachs EICC External Internal Casing Cutter Kit is designed to cut and chamfer the casing internally below the wellhead required for specific BOP installations. It is used in combination with an ECC Kit, which makes the external cut required before installing the EICC. Once the external cut is made, the MDSF split frame from the ECC Kit serves as the drive platform for the EICC.

A wellhead adaptor is required to mount the MDSF, either our Universal adapter or a custom adapter built to your specifications, serving as the mounting point between the wellhead and the MDSF. The EICC is assembled to the MDSF and lowered into the casing, and can be configured to cut down to a depth of 60in (1524mm). A reversing air motor is required and part of the EICC Kit, run forward to advance the tooling, then backwards to retract the tooling prior to extraction and completion.

Features

- Cuts up to 7in through 13 3/8in API casing.
- Utilizes standard Wachs Genuine Tooling for external severing and chamfering
- Optional specialized casing cutter tooling holder and inserts available
- Cutting platform uses the Wachs field-proven DynaPrep MDSF Split Frame
- Requires minimal axial and radial clearances; requires pneumatic reversible drive motor

SPECIFICATIONS	
Mounting System	Three-leg, universal chuck
Tool Slides	Standard (7in-9 5/8in) extended range 10 3/4in-13 3/8in mechanical starwheel feed
Counter	Mechanical/rotation
Tooling	Insert & holder/chamfer
Radial Travel	.63" (16mm) radial travel per slide
Wall Capacity	Can cut up to 5/8" wall thickness
Feed Rate	.0047"/rev (.1058mm/rev)
Power	Pneumatic

Machining Capacity

COMPATIBLE SPLIT FRAME	OD CASING SIZE	SPLIT FRAME SIZE	PART #
Model 814	7in - 9 5/8in (177.8 - 244.475mm)	8-14in (203.2-355.6mm)	69-4815-14
Extended Tool Slide Kit	10 3/4in - 13 3/8in (273 - 339.7mm)	8-14in (203.2-355.6mm)	60-4001-01

Casing/Conductor Cutting Range Chart

CASING SIZE	4.5IN (114MM)	5IN (127MM)	5.5IN (140MM)	6 5/8IN (168MM)	7IN (178MM)	7 5/8IN (194MM)	8 5/8IN (219MM)	9 5/8IN (244MM)	10 3/4IN (273MM)	11 3/4IN (298MM)	13 3/8IN (340MM)	16IN (406MM)	18 5/8IN (473MM)	20IN (508MM)	24IN (610MM)	26IN (660MM)
7in - 9 5/8in																
10in - 13 3/8in																

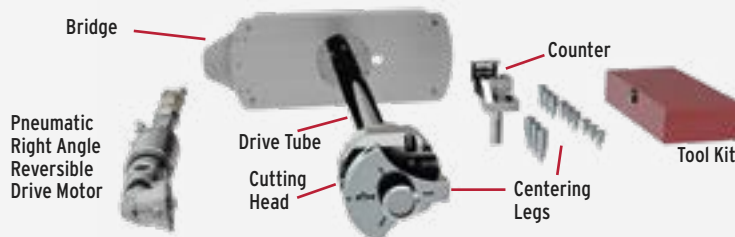

Size range includes most common casing conductor sizes



EICC Internal Casing Cutter used for wellhead completion



Internal cutting module lowered to cutting depth



MDSF EICC Internal Cut

EICC Kits, Accessories & Motors

DESCRIPTION	PART #
EICC Casing Cutting System for MDSF 814 Machine. Includes: <ul style="list-style-type: none"> • External/internal mount for cutting 7in, 7- 5/8in, 8- 5/8in and 9- 5/8in casing • Drive tube (adjustable cut depth from 6-31in) • Cutting head • Mounting chuck with extension legs to cover ID range • Drive tube-mounting adapter (Bridge mounts to MDSF 814 machine) • Trip Counter • 2 parting blades • 30° deburring tool • Operating tools • Shipping box • Manual 	69-4815-14
9 5/8in through 13 3/8in Slide Assembly	60-4005-02
EICC Slide & Leg Extension Kit	60-4001-01
Extension Leg Assembly to mount EICC clamping chuck into 7in, 7 5/8in, 8 5/8in and 9 5/8in casing	60-4006-01
Extension Leg Assembly to mount EICC clamping chuck into 10 3/4in, 11 3/4in and 13 3/8in casing	60-4006-02
MDSF 814 EICC Adapter Kit (Includes Bridge Assembly)	69-4820-14
MDSF 1420 EICC Adapter Kit (Includes Bridge Assembly)	69-4820-20
Mechanical counter Assembly for EICC system.	69-4743-00
31in Drive Tube Assembly	60-4009-31
42in Drive Tube Assembly	60-4009-42
48in Drive Tube Assembly	60-4009-48
54in Drive Tube Assembly	60-4009-54
Pinion Front Mounted Spline Drive Assembly (incompatible with 3.5in slide set)	69-4481-01
Pneumatic Right Angle Reversible Drive Motor Assembly w/Oiler & Speed Control	69-4353-01
Universal Wellhead Adapter	60-4011-03
Custom Wellhead Adapter	60-4011-XX
Bevel Tool Saddle Assembly, Inverted Machine	69-3093-00
Parting Tool Saddle Assembly, Inverted Machine	69-3094-00
Tool Cover Assembly, Inverted Machine	69-3092-00
Inverted Tool Slide, .003in Feed x 1.50in Stroke. Parting Only.	69-4612-03
Inverted Tool Slide, .003in Feed x 1.50in Strong. Parting and Beveling.	69-4611-03

Casing Cutting Tooling

DESCRIPTION	PART #
Tool Holder Kit, 45° Casing Bevel	69-7015-00
Tool Holder Kit, 60° Casing Bevel	69-7016-00
Tool Insert, 45° Casing Inside Bevel	69-7017-00
Tool Insert, 60° Casing Inside Bevel	69-7018-00
HSS Severing Tool for EICC system. (2) severing tools required per machine for use. (2-piece minimum order)	60-7000-01
HSS 20° OD Bevel Tool. 70° bevel when measured from casing centerline. (2-piece minimum order)	60-7001-20
HSS 30° OD Bevel Tool. 60° bevel when measured from casing centerline. (2-piece minimum order)	60-7001-30



EICC Bridge Assembly



Universal Wellhead Adapter



DuoEdge 45° Casing Bevel Tool Holder & Insert



DuoEdge 60° Casing Bevel Tool Holder & Insert

LDSF Large Diameter Split Frame



Four standard LDSF sizes cover 60-120in (DN1500-3000)



LDSF splits into quadrants for setup, transport & storage



LDSF standard dual hydraulic drive motors & dual pinion housings

Designed for Large Diameter Pipes & Vessels

E.H. Wachs LDSF Large Diameter Split Frame is designed for cold cutting, beveling, facing and counterboring on large diameter pipes, vessels and flanges. Engineered to incorporate multiple advancements, it's designed to be stronger, faster to set up, faster to operate, and even more versatile than our previous HDSF models.

Picking up where our DynaPrep MDSF Split Frames leave off, four standard LDSF sizes cover a range from 60-120in OD (DN1500-DN3000). New modules for machining heavy wall up to 6in (152.4mm) and a new, more versatile profile slide kit for single pointing makes the LDSF the most versatile machine in its category.

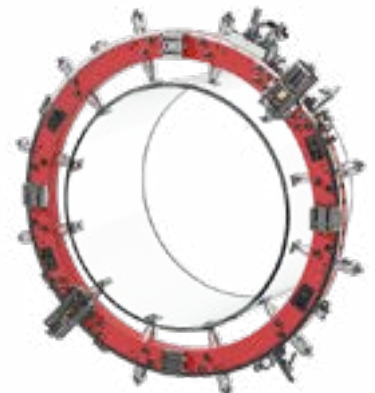

LDSF Split Frame

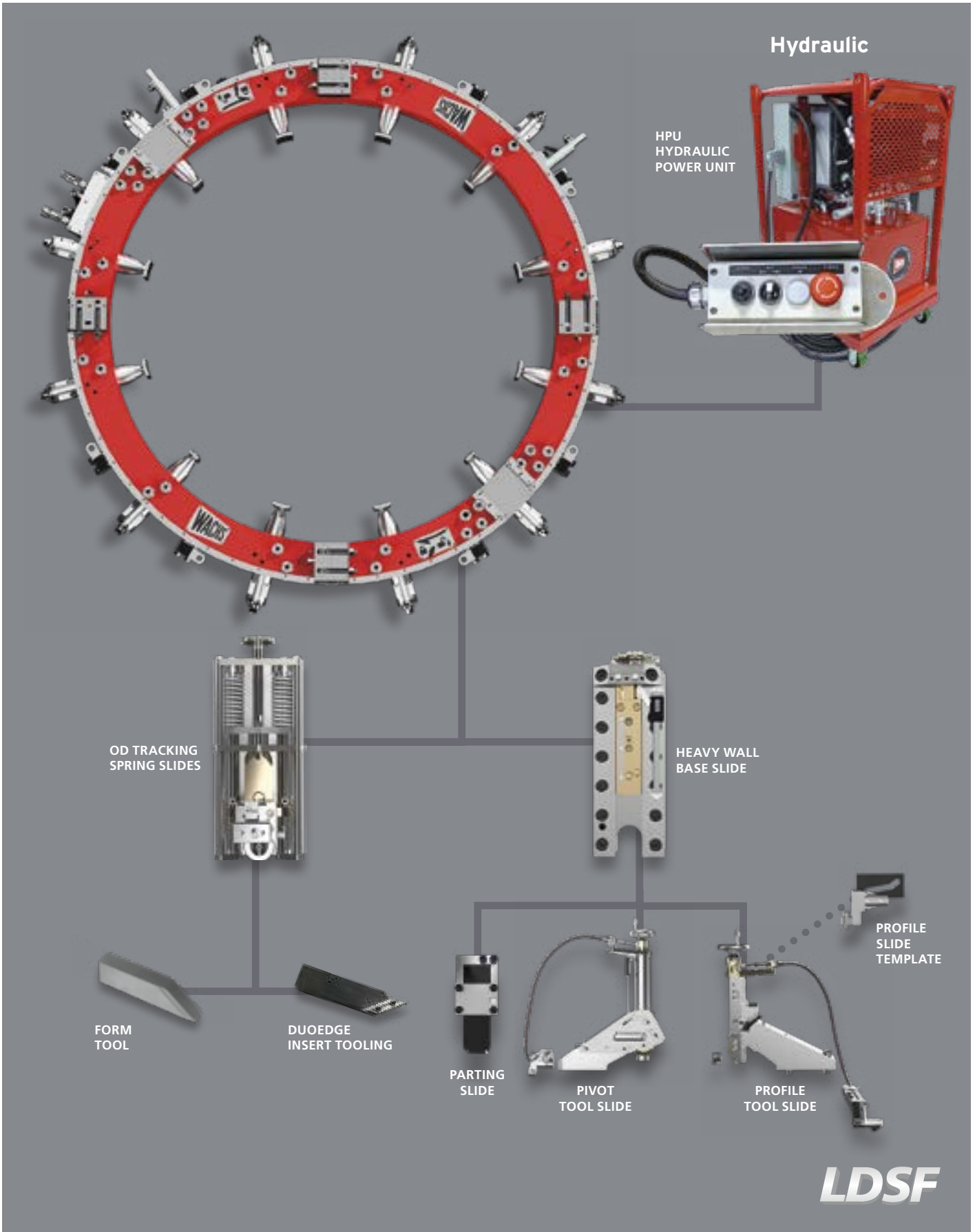

LDSF Split Frame Features

LDSF Large Diameter Split Frame

The internal, full bearing construction contributes to the LDSF's smooth operation and long service life. Spring loaded OD tracking slides for irregularly shaped or out-of-round pipe and vessels are standard, and allow the tooling to maintain continuous contact, producing precision weld preps with consistent lands. The LDSF takes corrosion protection to a new level with virtually every surface treated. Its attractive red powder coated finish proudly reflects E.H. Wachs famous red and black corporate colors.

New modules and kits broaden the versatility of the LDSF. Pivot Slide and Profile Slide kits allow for deep counterboring and heavy wall (up to 6in or 152mm) single point machining and profiling. A new flange facing adapter kit allows the LDSF to perform facing on very large diameter flanges. A new double parting kit allows for faster severing on even the heaviest wall or high alloy materials.

- Ideal for vessels & Steam Generator Replacement (SGR)
- Designed for large and very large diameter pipes and vessels
- Four standard LDSF sizes cover a 60in to 120in OD range (DN1500-3000)
- 15in (381mm) clamping diameter range across four standard LDSF models
- 30in (762mm) diametrical machining range including clamping leg and tool slide stroke
- Splits into quadrants for easier storage, transport and set-up
- All steel construction for durability and rigidity
- Common size, fully captivated fasteners used throughout
- Quick release, adjustable height setup legs, 3 per quadrant
- Self squaring mounting system features axially micro adjustable clamping legs
- Rigging blocks with lifting eyes allow horizontal or vertical lifting
- Multiple setup configurations for vertical or horizontal operation
- Includes operating hand tools and manual

Standard Equipment

- Dual hydraulic drive motors
- Heavy duty OD tracking tool slides
- Self re-setting trip assembly
- Lifting eyes for vertical or horizontal mounting
- Ratcheting hinge mechanism for opening & closing
- Self squaring mounting system with axially adjustable clamping legs
- Sealed dual pinion housings
- Custom wood storage case & quadrant end protectors

Additional Features

- Reinforcing stiffener blocks at the split lines offer increased rigidity
- Hinged open/close mechanism to simplify machine mounting
- Frame fastening swing bolts holds ring frames in place during assembly
- Dual hydraulic drive motors require less clearance than one large motor
- Dual drive reduces gear tooth loading for greater durability
- Drive motors utilize Wachs universal quick mount drive assembly
- Fully adjustable mounting legs replace traditional bolt on spacer feet
- Modular leg assemblies offer both ID and OD clamping options
- Designed to use a minimum number of hand tools
- Spring loaded trip design eliminates feed crashes



LDSF Split Frame



Swing bolts & hinge mechanism speeds assembly & mounting



LDSF includes OD Tracking Slides as standard equipment

LDSF Split Frame Specifications

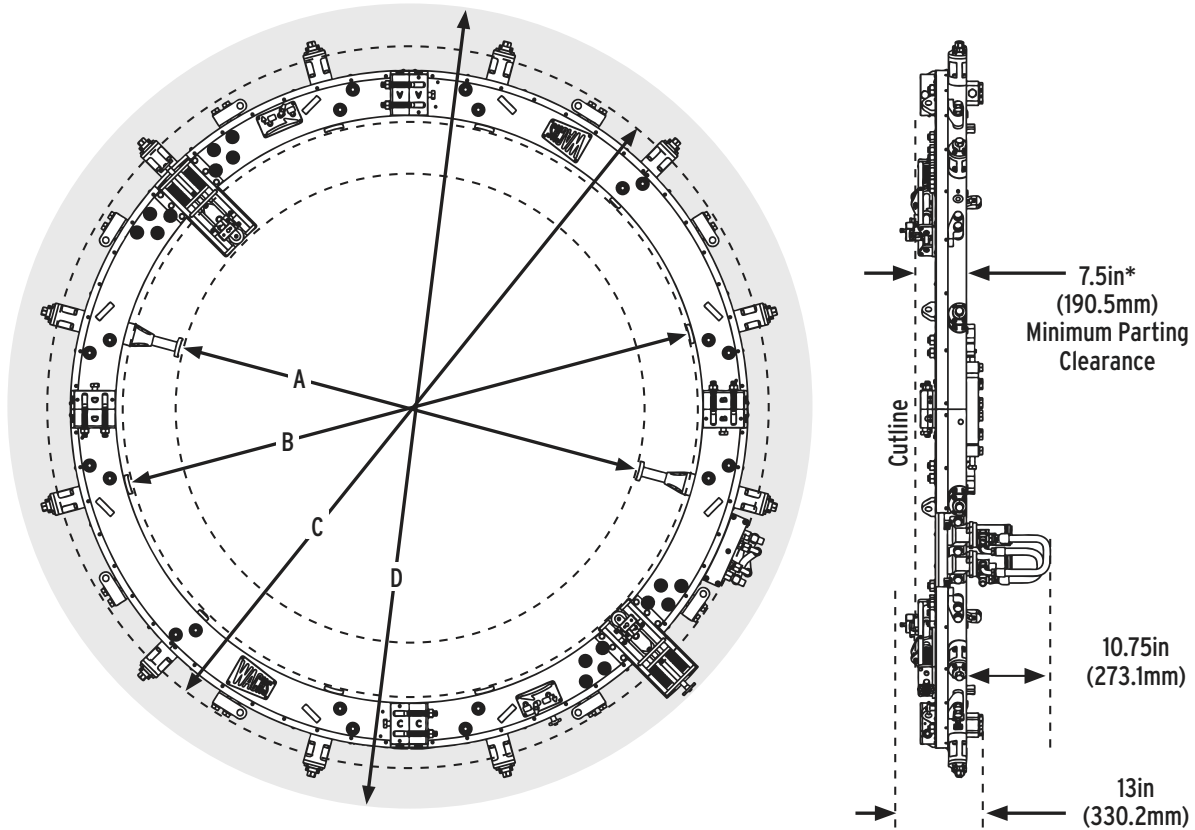

SPECIFICATIONS	LDSF 75	LDSF 90	LDSF 105	LDSF 120
Dimension "A - B" Machine capacity range (Nominal Pipe Size)	60-75in (1524-1905mm)	75-90in (1905-2286mm)	90-105in (2286-2667mm)	105-120in (2667-3048mm)
Dimension "C" pinion clearance	99in (2515mm)	114in (2896mm)	129in (3277mm)	144in (3658mm)
Dimension "D" Standard OD Tracking slide clearance	111in (2820mm)	126in (3200mm)	141in (3581mm)	156in (3962mm)
Dimension "D" Optional Heavy Wall Base Slide clearance	117in (2972mm)	132in (3353mm)	147in (3734mm)	162in (4115mm)
Machine height	13in* (330.2mm*)			
Hydraulic motor height	10.7** (271.8mm**)			
Cutting tool surface speed	Adjustable, 60 surface ft/min (18.28m/min)			
Hydraulic power requirements	14gpm @ 1800psi (53lpm @ 124BAR)			
Feed Methods	Mechanical Starwheel or Cable feed			
Feed Rates	0.0031in (0.0787mm) per trip w/ OD Tracking Slide			
	0.003846in (0.09769mm) per trip w/ Heavy Wall Base Slide			
	0.001 to 0.006in (0.0254 to 0.1524mm) per trip w/ axial operations (adjustable)			

* MINIMUM CLEARANCE SHOWN IS WITH STIFFENING BLOCKS REMOVED. ** STANDARD DRIVE MOTOR CONFIGURATION. REDUCED CLEARANCE OPTIONS AVAILABLE.

Construction

- Alloy steel stationary and rotating rings
- Alloy mounting legs
- High capacity bearings
- Dual heavy duty pinion housings
- Ratcheting hinge mechanism
- Stainless steel, nickel plating and powder coating for corrosion resistance

Optional Equipment

- Base slide kit
- Pivot slide kit*
- Profile slide kit*
- Flange facing adapter kit
- Genuine Wachs Tooling

*REQUIRES BASE SLIDE KIT

LDSF Split Frame Tool Slides

OD Tracking Slide

Standard equipment and included with the LDSF, the OD Tracking Slide is extremely versatile and suitable for typical applications including parting and beveling, and includes spring loaded trips to eliminate feed crashes. Utilizes standard Legacy and DynaPrep MDSF tooling.

Pivot Slide Kit

The LDSF Pivot Slide Kit is designed for ID or OD turning, facing and beveling. It's ideal for large diameter vessels, including steam generators, used in oil and gas and power generation applications. Used for extra heavy wall applications (up to 6in) with greater metal removal requirements on ID and OD profiles.

Profile Slide Kit

The LDSF Profile Slide Kit is a multipurpose slide that can be configured to bevel heavy wall pipe and vessels and face large diameter flanges. The Profile Slide utilizes standard and custom made interchangeable templates to perform precise compound bevels.

Parting Slide Kit

The LDSF Parting Kit features digital read out (DRO) for precise radial position indication. This module is designed for parting and beveling configurations.

Heavy Wall Base Slide

The LDSF Heavy Wall Base Slide serves as the mounting platform for the Parting Kit, Pivot Slide and Profile Slide Kits.

DESCRIPTION	PART #
Pivot Slide Kit*	12-042-4442-00
Profile Slide Kit*	12-042-4443-00
Template for Profile Slide Kit**	12-042-4445-00
Parting Kit*	12-042-4441-01
Heavy Wall Base Slide	12-042-4440-00

*REQUIRES MOUNTING BASE 12-042-4440-00, SOLD SEPARATELY.

**REQUIRES MOUNTING BASE 12-042-4440-00 AND 12-042-4443-00 PROFILE SLIDE, SOLD SEPARATELY.

Heavy Wall Insert Holders (includes insert screws and wrench)

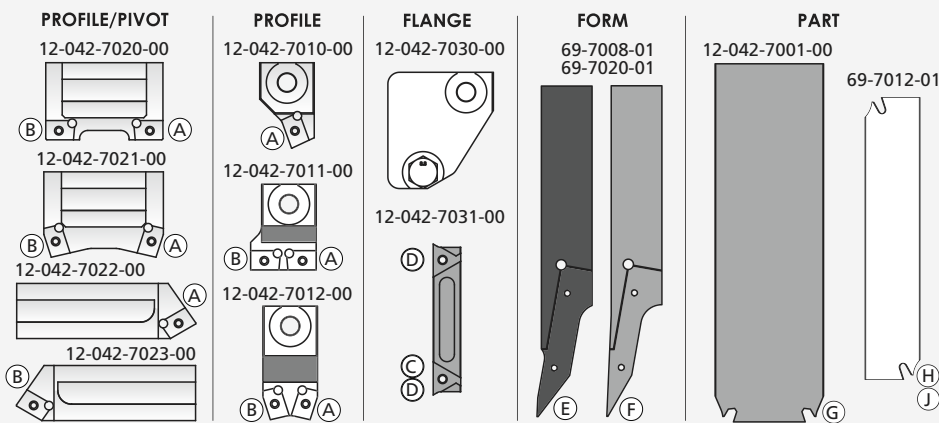

Heavy Wall Insert Tooling

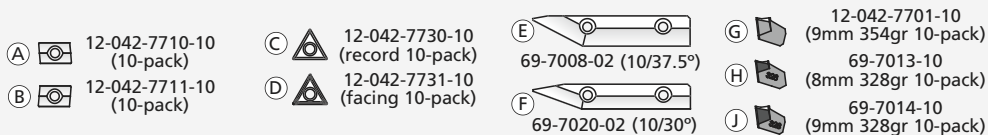

OD Tracking Slide



Pivot Slide Kit



Profile Slide Kit



Parting Kit



Heavy Wall Base Slide



Template for Profile Slide Kit

LDSF Split Frame Heavy Wall Kits

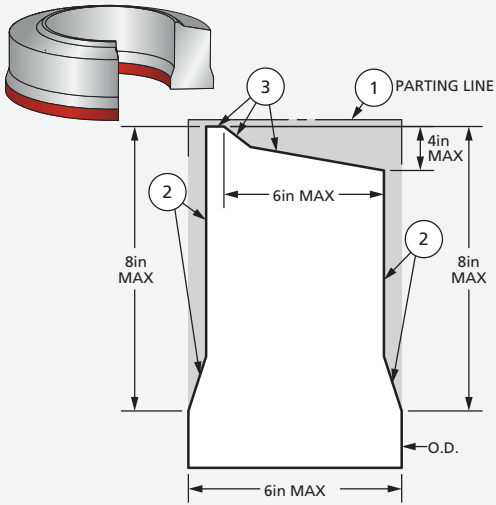

LDSF 6in Wall Tooling Setup 12-042-5701-00 (Rental # R12-042-5701-00)

	DESCRIPTION	PART #
ALL	(2) BASE SLIDE KIT	12-042-4500-00
ALL	FEED TRIP KIT	12-042-4506-00
1	PARTING KIT	12-042-4501-00
2	PIVOT SLIDE KIT	12-042-4502-00
3	PROFILE SLIDE KIT	12-042-4503-00

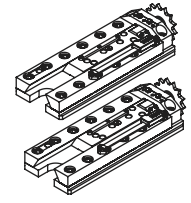

Heavy Wall Base Slide

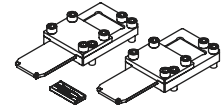

Parting Kit

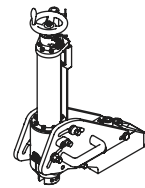

Pivot Slide Kit

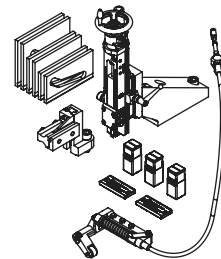

Profile Slide Kit

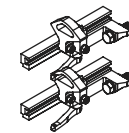

Feed Trip Kit

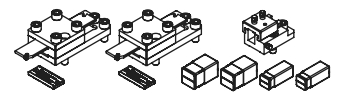

Form Tool Adapter Kit

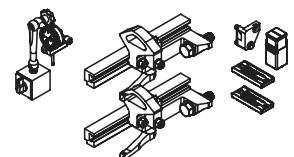

Flange Face Adapter Kit

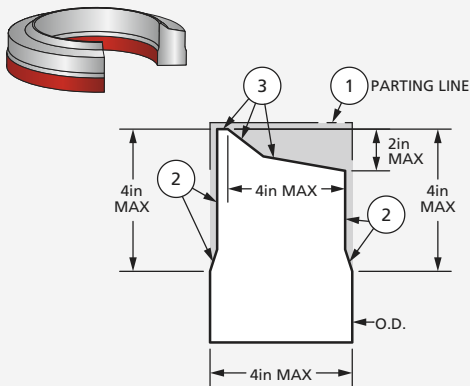

LDSF 4in Wall Tooling Setup 12-042-5702-00 (Rental # R12-042-5702-00)

	DESCRIPTION	PART #
ALL	(2) BASE SLIDE KIT	12-042-4500-00
ALL	FEED TRIP KIT	12-042-4506-00
1	PARTING KIT	12-042-4501-00
2,3	PROFILE SLIDE KIT	12-042-4503-00

LDSF Form Tool Adapter Setup 12-042-5703-00 (Rental # R12-042-5703-00)

	DESCRIPTION	PART #
2	PROFILE SLIDE KIT	12-042-4503-00
1,3	FORM TOOL ADAPTER	12-042-5703-00

* REQUIRES 4IN WALL KIT 12-042-5702-00

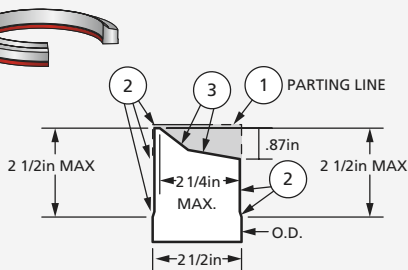

LDSF Flange Facing Adapter 12-042-5704-00 (Rental # R12-042-5704-00)

	DESCRIPTION	PART #
ALL	FLANGE FACING ADAPTER KIT	12-042-5704-00

* REQUIRES 4IN WALL KIT 12-042-5702-00

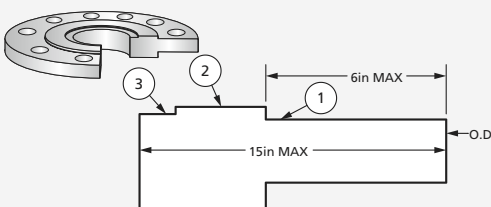

TRAV-L-CUTTER Pipe Cutter



Horizontal & vertical cutting



Fast & accurate cutting & beveling



Add mounting chain sections to fit larger diameters

Cold Cutting, Compact Design, Easy Set-Up

The Wachs Trav-L-Cutter is a portable milling machine capable of cold cutting and beveling simultaneously on all machinable pipe materials, pipe schedules and pipe sizes from OD 6in - 72in (152.4-1829mm).

Mounted by its own tensioning chain, the Trav-L-Cutter drives itself around the pipe as it machines. For larger diameter pipe or vessels, simply add more drive chain sections. For greater accuracy specify the Trav-L-Cutter Guide Track. Available with pneumatic (Model E) and hydraulic (Model HE) drive options.



TRAV-L-CUTTER Features

Portable Pipe Milling Machine

Fast & Accurate

Wachs high-performance cutters remove 3/16in (4.8mm) of metal while cutting, leaving the pipe end with a smooth, machined finish. The chain feed system maintains continuous out-of-round compensation while providing constant drive under all conditions for accurate cuts. By using an optional guide track and special guide track wheels, higher accuracy can be maintained. This cutting method facilitates section removal in the field where new sections, pre-cut by the same method, can be easily dropped into place.

Operates Anywhere

The Trav-L-Cutter operates on horizontal or vertical pipe, in the field or the shop.

Machines Most Materials

Materials such as carbon steel, ductile iron, cast iron and most alloys in all pipe sizes from 6in to 72in (152.4-1829mm) can be cold cut and beveled simultaneously.

Corrosion Resistance

Hydraulic models offer the inherent advantages of a completely sealed and self-lubricating closed loop system. The Model HE is particularly suited to field machining operations under the type of hostile conditions often found on offshore drilling rigs, pipelines and other construction work.

Both the HE and E models feature corrosion resistant components including stainless steel, hi-spec bearings and anti-corrosive finishes.

Trav-L-Cutter Features

- Safe cold cutting
- Simultaneous cutting and beveling
- Compact design, easy set-up
- Horizontal and vertical cutting
- Mounts to larger diameters with additional chain

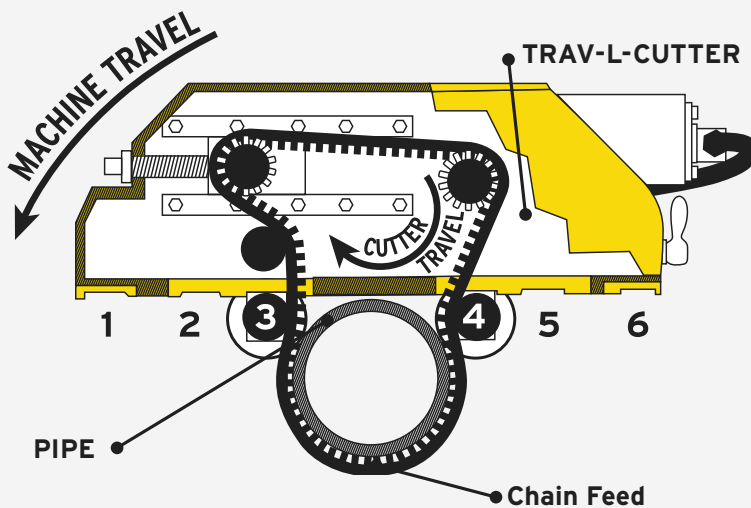

Model HE Hydraulic



Trav-L-Cutter shown in steel storage case



Trav-L-Cutter is designed for pipeline operations.



First generation Trav-L-Cutter photo circa 1952

TRAV-L-CUTTER Specifications

SPECIFICATIONS	
Machining capacity	6in - 72in (152-1829mm)
Cutter drive	Pneumatic: Governed air motor coupled with worm gearbox. Hydraulic: As above, with hydraulic motor.
Cutter speed	Pneumatic: Adjustable from 35-55rpm for use on work-hardened alloys. Hydraulic: Adjustable from 0-60rpm.
Feed	Pneumatic: Air motor coupled through overload clutch, gearbox and chain reduction to final machine drive sprocket. Hydraulic: 4hp (2.9kW) hydraulic motor.
Feed method	Positive, nonslip chain drive
Air requirements	100cfm at 90psi (2.8m ³ /min)
Hydraulic requirements	15gal/min at 1500psi (55l/min)
Work speed	Provides cutting time of 1inch/min of pipe diameter. 10in (254mm) = 10 minutes. Over.5in (12.7mm) wall and most alloys require reduced feed rate.
Clearance	Radial: 10in - 12in (254-305mm) Axial: 20in (508mm)
Controls	Cutter on-off, feed on-off, with interlock to prevent machine feed unless cutter is turning, adjustable feed control. Flow control valves (Model HE only). Separate controls provide adjustable spindle speed and cutter speed. Forward/reverse valve governs machine travel direction.
Weight	Operating: 215lb (97.5kg) Shipping: 418lb (189.6kg)
Finish	Corrosion resistant powder coat
Dimensions (LxWxH)	24 x 20 x 10.75in (61 x 51 x 28cm)

Standard Equipment

- Air line lubricator (air only)
- Filter (air only)
- Speed control
- Operating manual and isometric parts list
- Operating tools
- Connecting pins
- Basic mounting chain for 6in - 48in (152-1219mm) diameter pipe
- Steel storage case
- 6ft whip hose without oiler (air only)

Optional Equipment

- Additional chain sections
- Additional cutter blades
- Guide track and wheels to fit all pipe sizes up to 48in (1219mm) for vertical cutting multiple pass cutting or high accuracy cutting
- Long cutter spindle for use with grooving cutters

ITEM	MODEL	DRIVETYPE	PIPE OD	PART #
Trav-L-Cutter	E	Pneumatic	6-72* (152-1829*)	02-000-01
Trav-L-Cutter	HE	Hydraulic	6-72* (152-1829*)	02-000-02

* STANDARD EQUIPMENT INCLUDES A BASIC MOUNTING CHAIN FOR OD 6IN - 48IN (152-1219MM) ONLY.



Model E Pneumatic



Trav-L-Cutter is in use worldwide



Heavy duty steel storage case hinges open for easy access



Trav-L-Cutter being used for submarine decommissioning

TRAV-L-CUTTER Tooling

Slitting Saw Blades

ITEM	SAW BLADE Ø	SAW BLADE THICKNESS	FOR PIPE MATERIALS	WALL THICKNESS MAX.	PART #
Slitting Blade HSS	6in (152.4mm)	3/16in (4.8mm)	Steel	1in (25.4mm)	02-601-00
Slitting Blade HSS*	7in (177.8mm)			1.5in (38.1mm)	02-602-00
Slitting Blade HSS**	7in (177.8mm)			92in (7.1mm)	02-603-00
Slitting Blade HSS	8in (203.2mm)	3/16in (4.8mm)		Ductile, cast iron	2.125in (54.0mm)
Slitting Blade Carbide tipped	6in (152.4mm)		1in (25.4mm)		02-605-00
	7in (177.8mm)		1.5in (38.1mm)		02-606-00
	8in (203.2mm)		2.125in (54.0mm)	02-607-00	



6in HSS Slitting blade



7in HSS Slitting blade



5in 30° Left Hand Bevel cutter

Bevel Cutters

VERSION	BEVEL CUTTER Ø	BEVEL CUTTER THICKNESS	BEVEL ANGLE	MAX. WALL THICKNESS	PART #
Left hand (inside)	5in (127.0mm)	.5in (12.70mm)	30°	.75in (19.05mm)	02-608-LH
Right hand (outside)					02-608-RH
Left hand (inside)	5in (127.0mm)	.5in (12.70mm)	37.5°	.625in (15.88mm)	02-609-LH
Right hand (outside)					02-609-RH
Left hand (inside)	6in (152.4mm)	.75in (19.05mm)	30°	1in (25.40mm)	02-610-LH
Right hand (outside)					02-610-RH
Left hand (inside)	6in (152.4mm)	.75in (19.05mm)	37.5°	.875in (22.23mm)	02-611-LH
Right hand (outside)					02-611-RH

Saw Blade & Bevel Cutter Combination Options

Example: Cutting and beveling up to .75in (19.05mm) wall thickness

BLADE	BLADE Ø	BLADE THICKNESS	BEVEL ANGLE °	WALL THICKNESS MAX.	PART #
HSS Slitting Blade	6in (152.4mm)	.1875in (4.8mm)	-	1in (25.4mm)	02-601-00
Bevel cutter Left hand (inside)	5in (127.0mm)	.5in (12.70mm)	30	.75in (19.05mm)	02-608-LH
Bevel cutter Right hand (outside)	5in (127.0mm)	.5in (12.70mm)	30	.75in (19.05mm)	02-609-RH



6in 30° Left Hand Bevel cutter

Example: Cutting and beveling up to 1in (25.4mm) wall thickness

BLADE	BLADE Ø	BLADE THICKNESS	BEVEL ANGLE °	WALL THICKNESS MAX.	PART #
Slitting Blade HSS**	7in (177.8mm)	.28in (7.1mm)	-	1.5in (38.1mm)	02-603-00
Bevel cutter Left hand (inside)	6in (152.4mm)	.75in (19.05mm)	30	1in (25.4mm)	02-610-LH
Bevel cutter Right hand (outside)	6in (152.4mm)	.75in (19.05mm)	30	1in (25.4mm)	02-610-RH
Spacer Kit 3/16, 11/16, 3/4	-	-	-	-	02-500-03



Inside Outside Bevel with Slitting Blade

* FOR PARTING ONLY

** FOR USE WITH 6IN BEVEL CUTTER

TRAV-L-CUTTER Accessories

Clamping Chains

ITEM	PIPE OD	CHAIN LENGTH	PART #
Clamping chain	- per linear inch -		call
Chain assembly	6-48in (152.4-1219.2mm)	173in (4394mm)	02-450-48
Chain assembly	54-72in (1371.6-1828.8mm)	67in (1702mm)	02-450-72
Connecting pin			02-158-00

Guide Tracks

GUIDE TRACKS REQUIRE PURCHASE OF GUIDE TRACK WHEEL (SET OF TWO).

DESCRIPTION	PART #
6in (108.3mm) Track	02-428-06
8in (219.1mm) Track	02-428-08
10in (273.1mm) Track	02-428-10
12in (323.9mm) Track	02-428-12
14in (355.6mm) Track	02-428-14
16in (406.4mm) Track	02-428-16
18in (457.2mm) Track	02-428-18
20in (508.0mm) Track	02-428-20
22in (558.8mm) Track	02-428-22
24in (609.6mm) Track	02-428-24
26in (660.4mm) Track	02-428-26
28in (711.2mm) Track	02-428-28
30in (762.0mm) Track	02-428-30
32in (812.8mm) Track	02-428-32
34in (863.6mm) Track	02-428-34
36in (914.4mm) Track	02-428-36
38in (965.2mm) Track	02-428-38
40in (1016.0mm) Track	02-428-40
42in (1066.8mm) Track	02-428-42
48in (1219.2mm) Track	02-428-48

Miscellaneous Accessories & Spare Parts

ITEM	PART #
Hydraulic hose set 13.9m (45ft 5/8in). Includes 4 sets M/F quick disconnects. FOR USE WITH TRAV-L-CUTTER MODEL HE	02-408-00
Hydraulic female disconnect	09-025-00
Hydraulic male disconnect	09-026-00
Set of 2 guide track wheels	02-429-00
Spare parts kit with air motor (includes both air motors)	02-500-01
Spare parts kit	02-500-02
Steel wedges	02-175-00

Hydraulic Power Units

For available Hydraulic Power Unit options, see page 74.

Cutting Lubrication KSS-TOP

Cutting lubrication "KSS-TOP", see page 51.



Chain assembly & pins



Guide track



Gasoline Driven
HPU Hydraulic Power Unit



KSS Top

GUILLOTINE Saw



Famous "Wachs Saw" is used around the world



Unique elliptical stroke for extended blade life



Goliath Saw shown on large diameter conductor

Fast Setup & Cutting, Horizontal or Vertical

E.H. Wachs family of portable Guillotine® pipe saws are designed to cold cut 2in - 32in (DN 50-800) pipe, as well as solids such as bar stock, rails and beams. Their compact design and easy setup make it the ideal saw for contractors, pipeline operations, refineries, petrochemical and processing plants and anywhere a fast, safe cut is needed.

In use virtually everywhere, Wachs Guillotine reciprocating saws are strong yet light, simple to mount, simple to operate and simply bulletproof. It's no wonder that when pipe saws are first mentioned, the "Wachs Saw" is mentioned first.



GUILLOTINE Saw

Super C, Model D, Super D, Goliath

- Rugged yet compact design requires minimal clearances
- Four models cut from 2in - 32in (DN 50-800)
- Fast setup and cutting, both horizontally or vertically
- Pneumatic, hydraulic and electric drive options
- Optional autofeed and autoclamping on select models

Easy Setup, Vertical or Horizontal

A chain pipe vise clamps the Guillotine Saw to the pipe. The machined cast iron "V"-saddle base assures square cuts at right angles. It can be mounted on horizontal as well as vertical piping. Custom bases for unusual workpiece shapes such as I beams available by special order.

Quick Cold Cuts, Minimal Clearance

Wachs Guillotine saws require minimal clearance (the model Super C needs as little as 1.5in (38.1mm) on one side of the pipe). All models feature finger tip feed control. The pipe is cold cut in a matter of minutes. A 6in (152.4mm) standard wall steel pipe is cut in only 6 minutes. A 16in (406.4mm) diameter 0.5in (12.7mm) wall steel pipe is cut in about 20 minutes.

Portable, Rugged Design

The Guillotine Saws combine compact size and light weight with simple, rugged construction for ease of operation and low maintenance.

Long Blade Life

The high-speed steel blades are easily changed. The unique Guillotine cutting action lifts the blade from the cut on the return stroke, extending blade life.



Guillotine Super C



Elliptical cutting action, long blade life

DIMENSIONS	SUPER C	MODEL D	SUPER D	GOLIATH
Machine capacity	2-12in (DN 50-300)	6-18in (DN 150-450)	10-24in (DN 250-600)	16-32in (DN 400-800)
Solids through	12.75in (324mm)	18.625in (473mm)	24.5in (622mm)	33in (838mm)
Clearance overall width	28in (711mm)	32in (813mm)	39in (991mm)	66in (1.676mm)
Clearance on one side min.	2.5in (63.5mm)	3in (76mm)	3in (76mm)	66in (1.676mm)
Operating Weight	115lb (52kg)	340lb (154kg)	515lb (234kg)	1800lb (816.5kg)
Shipping Weight	180lb (82kg)	415lb (188kg)	620lb (281kg)	1800lb (816.5kg)
Dimension A	23.5in (596,9mm)	31.25in (794mm)	38.25in (972 mm)	66in (1676.4mm)
Dimension B	12.75in (323,85mm)	14.5in (368mm)	14.5in (368mm)	25in (635mm)
Dimension C	31.5in (800mm)	37in (940mm)	44in (1118mm)	76.5in (1943mm)
Dimension D	13.25in (337mm)	18.75in (476mm)	24.75in (629mm)	33in (838mm)
Stroke	2in (51mm)	2in (51mm)	4in (102mm)	
Shipping dimensions (estimated)	26in x 29in x 22in (66cm x 74cm x 56cm)	63in x 47in x 29in (160cm x 119cm x 74cm)	CALL	CALL

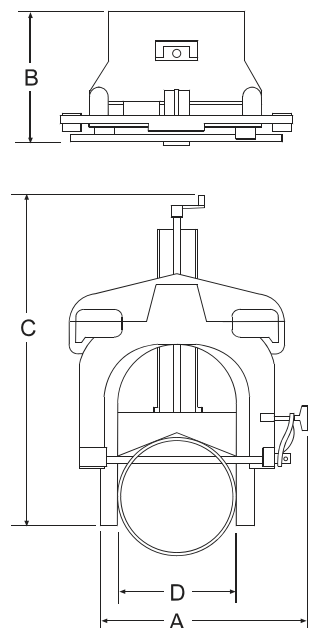

GUILLOTINE Specifications

Specifications

Drive options: Pneumatic or hydraulic (Goliath hydraulic drive only)

Pneumatic drive: 50 cfm at 85 psi (1.4 m³/min at 5.0 BAR)

Electric drive: 15 A, 110 or 220 Volt single phase

Hydraulic drive: 10gal/min at 1500 psi (38 l/min at 106 BAR)

Controls: Single crank, manual feed. Motor on-off.

Lubrication: Grease fittings at all wear points

Finish: Powder coat frame with zinc coated bow

Standard Equipment

- Drive motor (pneumatic or hydraulic)
- 1 Standard saw blade
- Wrench 1 1/4in (31.75mm)
- Air lubricator and filter (Air Model)
- Steel storage case (Model C and D only)
- Lifting eyes (Model D and Super D)
- Mounting chains
- Manual

Optional Equipment

- Blades: HSS and carbide blades (depending on the machine version)
- Control Panel for remote operation
- Autoclamp mechanism
- Autofeed mechanism
- Custom mounting bases

Guillotine Saw Kits

DESCRIPTION	PIPE OD	PART #
Super C Pneumatic	2-12in (DN 50-300)	24-000-02
Super C Hydraulic	2-12in (DN 50-300)	24-000-03
Super C Autoclamp Hydraulic	2-12in (DN 50-300)	P06-150-502
Super C Autoclamp & Autofeed Hydraulic	2-12in (DN 50-300)	P06-150-500
Model D Pneumatic	6-18in (DN 150-457)	04-000-02
Model D Hydraulic	6-18in (DN 150-457)	04-000-03
Super D Pneumatic	10-24in (DN 250-610)	25-000-01
Super D Hydraulic	10-24in (DN 250-610)	25-000-03
Super D Autoclamp Hydraulic	10-24in (DN 250-610)	P06-150-512
Super D Autoclamp & Autofeed Hydraulic	10-24in (DN 250-610)	P06-150-510
Goliath Hydraulic	16-32in (DN 400-800)	P06-150-523
Goliath Autoclamp Hydraulic	16-32in (DN 400-800)	P06-150-522
Goliath Autoclamp & Autofeed Hydraulic	16-32in (DN 400-800)	P06-150-520



Guillotine cutting pipe



Guillotine Goliath cutting powerplant turbine shaft



Cuts a wide variety of materials



Field proven performance

Miscellaneous Accessories & Spare Parts

DESCRIPTION	MODEL COMPATIBILITY				PART #
	MODEL C	SUPER C	MODEL D	SUPER D	
Air motor conversion (replaces all obsolete motors)	x				03-414-00
Lubricator retrofit kit	x	x	x	x	03-500-10
Spare parts kit	x	x			03-500-01
Spare parts kit			x		04-500-01
Spare parts kit				x	25-500-01
Manual - Electronic version via e-mail available free upon request.					03-MAN-01

Hydraulic Power Units

For available Hydraulic Power Unit options, see page 74.

Cutting Lubrication

Water soluble, biodegradable, non-hazardous, fully synthetic cooling fluid that extends the tooling life

DESCRIPTION	VERSION	WEIGHT	PART #
Cutting lubrication KSS-TOP	Pump sprayer with 500 ml	1.39lb (630 g)	0T790.060.226
Cutting lubrication KSS-TOP refill canister	Canister with 10 l	24.25lb (11kg)	0T790.060.227









Diesel Powered
HPU Hydraulic Power Unit



Cutting Lubrication KSS Top

Saw Blades

PROFILE	DESCRIPTION	APPLICATION	PART #
	Model C HSS standard blade	For general use	03-405-00
	Model Super C standard blade - general use	Carbon steel pipe, stainless steel and other high alloy materials	24-405-00
	Model Super C carbide blade	Cast, ductile and concreted lined pipe	24-405-01
	Model D HSS standard blade	Carbon steel pipe, stainless steel and other high alloy materials	04-402-00
	Model D carbide blade	Cast, ductile and concreted lined pipe	04-405-01
	Model Super D heavy duty blade	Carbon steel pipe, stainless steel and other high alloy materials	25-402-00
	Goliath heavy duty blade	For general use	P06-150-701

ID Mounted Machine Tools



End Prep Machines & Flange Facers

E.H. Wachs machine tools are broadly divided into OD mounted machines and ID mounted machines. ID mounted machine tools fall into the end prep category, meaning they machine the end of a pre-cut pipe or workpiece. Wachs ID mounted machines use a mandrel (or in specific cases a chuck head) that expands into the pipe inside diameter to hold fast. An inherent advantage of mandrels is they self center when tightened, assuring a high precision end prep.

ID mounting is also useful for special applications such as prepping elbows, with mandrels and fittings offered specifically for that purpose.

E.H. Wachs ID mounted products include our field proven SDB Small Diameter Beveler series and the related FF Flange Facing series. These machines offer incredible flexibility by utilizing common components where users can order and configure the machine as an SDB beveler, an FF flange facer or as both, so one machine can take the place of two.

Wachs best selling EP 424 is the ideal machine for heavy wall applications. It's available in three models, the basic Form Tool model and the Deluxe and Premium Single Point models that features our exclusive, patented AutoFeed system. The AutoFeed mechanism allows the user to select and change the bevel angle on the fly, the fastest and most precise way to create bevels, compound bevels and J Preps on the toughest steel and high alloy materials.

It's the perfect machine for newer or less experienced operators to deliver professional results right from day one. And like the convertible SDB series the EP 424 can be used to face large diameter flanges up to 24in (610mm) OD., or up to 36in (914mm) with its optional single point tool slide.



















EP 424 End Prep with AutoFeed performs pipe end preps & flange facing



SDB End Prep performs pipe end preps & can be converted for flange facing

ID Mounted Machine Ranges

	1/2in (13mm)	4in (102mm)	8in (203mm)	12in (305mm)	16in (406mm)	24in (610mm)	36in (914mm)	
EP 424 END PREP	EP 424 FORM TOOLING							
	EP 424 SINGLE POINTING							
SDB SMALL DIAMETER BEVELER	SDB 103							
	SDB 206							
	SDB 412							
FF FLANGE FACER	FF 206							
	FF 313							
	FF 424							

EP 424 End Prep

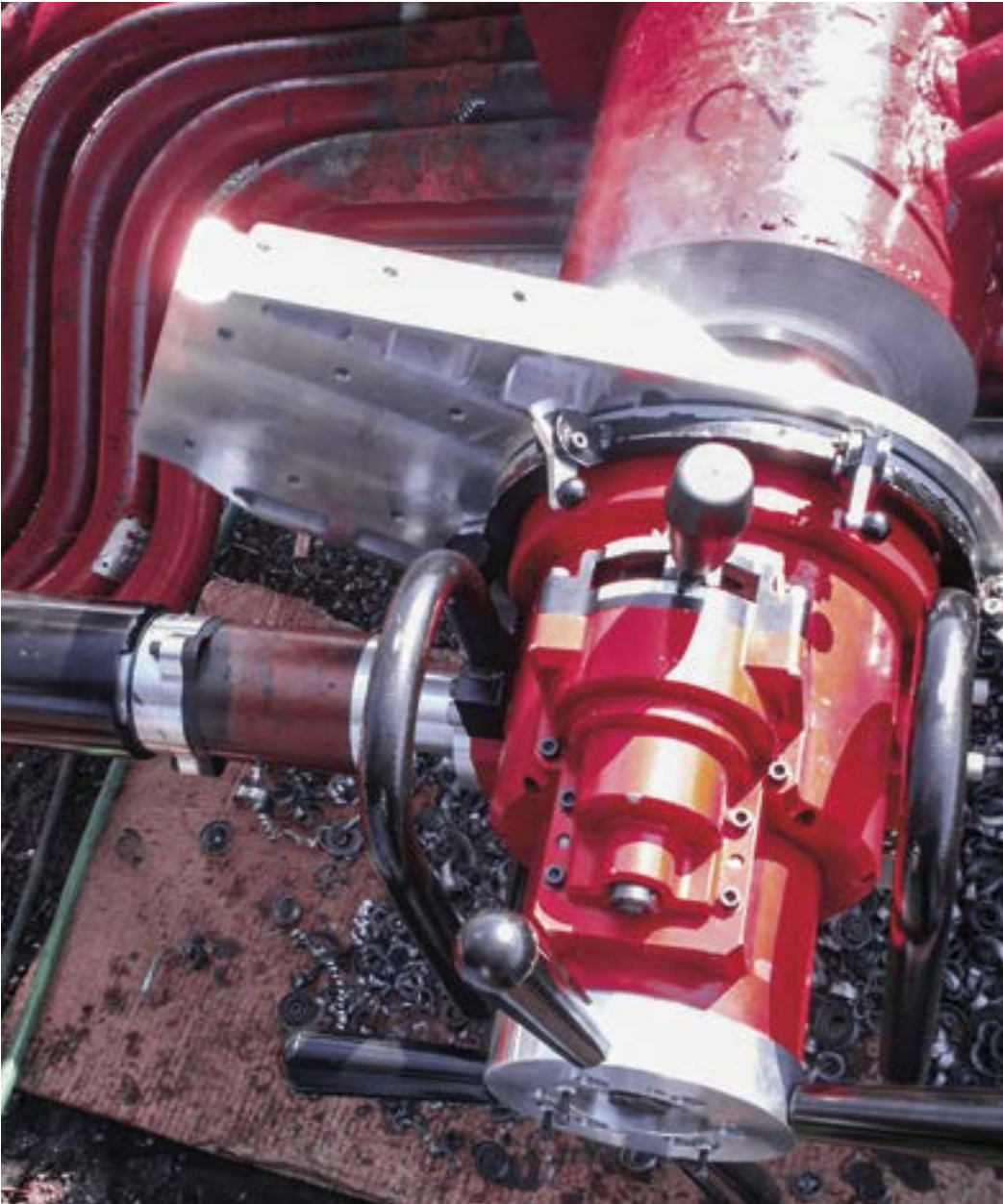

EP 424 is ideal for heavy wall



SpeedPrep™ AutoFeed mechanism



Hydraulic (shown), Electric & Pneumatic drive options

Innovative SpeedPrep™ AutoFeed

The Wachs EP 424 with the SpeedPrep™ AutoFeed system is a precision ID mount end prep machine tool designed to bevel, compound bevel, J prep, face and counterbore pipe, fittings and valves. The EP 424 machines any bevel or compound bevel without templates, incline tool slides or work stoppage.

It's powerful enough to form tool from 4-14in (DN 100-350) and single point from 8-24in (DN200 - 600) up to a 6.5in (165mm) wall thickness. The EP 424 can single point and face flanges up to 36in utilizing its optional tool slide. The SpeedPrep™ AutoFeed system makes the EP 424 the most advanced end prep machine in the industry.



EP 424 End Prep

Prior to the EP 424, most end prep machines required a mechanical template or incline tool slide to reproduce the specific and complex preps called for by today's processes. With Wachs AutoFeed system, it's now possible to dial in the exact prep needed for your application. Select the bevel angle and the land that works best for your application, without work stoppages or additional components. More versatile and powerful than any other machine of its kind, the Wachs EP 424 sets the standard in user friendly large diameter end prep.

Features

- Safe cold cutting process, eliminates heat affected zone
- Lathe machining delivers precise compound bevels and consistent lands
- EP 424 eliminates the need for accessory templates or external tool slides
- Fast setup and prep with standard self-centering mandrel legs
- Corrosion resistant finishes on all components for extreme environments
- Fully enclosed bearings and drive gears for safety and durability

Specifications

System function:

ID mount end prep machine tool designed to bevel, compound bevel, J-prep, face and counterbore pipe, fittings and valves

Capacity OD:

4-24in (DN 100-600)

Up to 36in (DN 900) with optional slide

Drive options:

Hydraulic, pneumatic or electric

Pneumatic requirements:

95cfm at 90 psi

(2.7m³/min at 6.2 BAR)

Hydraulic requirements:

8gal/min at 1500 psi

(30l/min at 103 BAR)

Feed method: AutoFeed system with dial control or fully manual

Feed rate:

Variable feed rate, user adjustable

Feed stroke (axial): 2.8in (71.1mm)

Machine rotating speed:

0-14rpm (variable)

- Low friction bearing system provides maximum stability, eliminating chatter

Design Capabilities

- Machine perfect preps from OD 4in - 24in (DN100 - 600)
- Form tool pipe from OD 4in - 14in (DN 100-350)
- Single point machining from OD 8in - 24in (DN 100-600)
- Single point Up to 36in (DN 900) with optional slide
- Fully modular construction for one man setup and operation

Construction:

Lightweight aluminum housing, oversize hardened alloy steel fully enclosed gear sets, high capacity bearings, rigid mandrel legs, captivated hardware

Finish: Multistage bright red enamel finish plus black oxide and clear coated components

Tooling: Accepts standard Wachs single point beveling and form tools, high speed steel or carbide tooling

Tool slots: Form tooling or single point tooling (varies by model)

Packaging: Heavy duty storage case

Length:

Without Mandrel 12.35in (314mm)

With Mandrel 26.75in (680mm)

Weight: Full modular construction with each module under 31.75kg (70lb), total weight with storage case 71.67kg (158lb)



EP 424 Flange Facing with single point machine slide



Cross section of EP 424 mounted for single pointing



EP 424 Single Point Deluxe with form tooling rotating head



Faces flanges up to 36in (914mm) with optional slide

EP 424 End Prep

Pneumatic



ACM AIR
REMOTE
CONTROL
MODULE



PNEUMATIC
STRAIGHT DRIVE
MOTOR

Hydraulic



HPU
HYDRAULIC
POWER UNITS



HYDRAULIC
DRIVE
MOTOR

Electric



EIBENSTOCK HD

POWER BOX



REMOTE
CONTROL



EIBENSTOCK
HD DRIVE
MOTOR



EP 424
END PREP

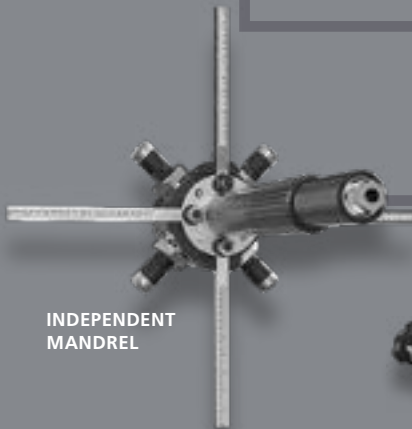

INDEPENDENT
MANDREL



STANDARD
MANDREL

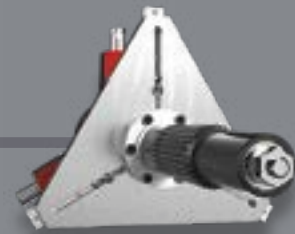

ELBOW MANDREL

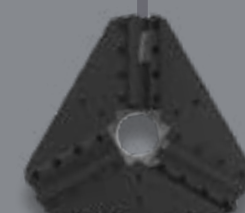

FORM TOOL ROTATING HEAD



SINGLE POINTING SLIDE



36in SINGLE POINTING SLIDE

EP 424 End Prep

EP 424 Kits

	EP 424 Form Tool Basic			EP 424 SpeedPrep™ Deluxe			EP 424 SpeedPrep™ Premium		
	PNEUMATIC DRIVE	HYDRAULIC DRIVE	ELECTRIC DRIVE ADAPTER	PNEUMATIC DRIVE	HYDRAULIC DRIVE	ELECTRIC DRIVE ADAPTER	PNEUMATIC DRIVE	HYDRAULIC DRIVE	ELECTRIC DRIVE ADAPTER
				Form Tooling Rotating Head Assembly 4-16in OD (102-406mm)					
							Single Point Slide ID 4.24-24in OD (108-610mm)		
				Standard Self-Centering Mandrel ID 3.27-15.96in (83-405mm)					
							Standard Self-Centering Mandrel ID 14.87-23.64in (378-600mm)		
								Independent Mandrel ID 8.5-22.6in (215.9-574mm)	
							SpeedPrep™ AutoFeed		
Part #	81-000-01	81-000-02	81-000-07	81-000-05	81-000-06	81-000-09	81-000-03	81-000-04	81-000-08

*ELECTRIC MODELS INCLUDE ELECTRIC DRIVE MOTOR ADAPTER ONLY. EIBENSTOCK HD DRIVES SOLD SEPARATELY

Standard Equipment

- Tool slide or rotating head (varies by kit)
- Heavy duty storage case
- Standard mandrel
- Extension leg kit
- Self squaring mounting system
- Operating hand tools
- Operation manual

Optional Equipment

- Independent mandrel for miters or elbows
- Elbow Mandrel
- Electric drive motor remote control options
- ACM Remote Control Module and ATM Air Treatment Module for pneumatic drive
- Interchangeable tool slides
- 36in Single Point Slide
- Genuine Wachs tooling
- SpeedPrep™ AutoFeed Upgrade kit for Form Tool Basic Model

Mandrels

DESCRIPTION	APPLICATIONS	PART #
Standard Mandrel	Flange Facing, Single Pointing, & Form Tooling	81-303-00
Independent Mandrel	Flange Facing, Single Pointing, Form Tooling, & Miter Beveling for straight pipe	81-305-00
Elbow Mandrel	Flange Facing, Single Pointing, Form Tooling, & Miter Beveling for mounting to curved sections of pipe and junctions	81-315-00



EP 424 SpeedPrep™ deluxe beveling with form tool rotating head



EP 424 SpeedPrep™ deluxe prepping heavy wall pipe



Self-centering standard mandrel



Independent Mandrel

EP 424 Tooling

EP 424 SpeedPrep™ AutoFeed Upgrade

Converts form tool model to SpeedPrep™ model.

Includes

- Single point radial tool slide for ID 4.25in (108mm) to OD 24in (609.6mm)
- 6.5in (165mm) slide travel
- AutoFeed axial feed gear box for bevel generation up to 45°
- Chuck leg extensions for ID range 14.87in - 23.64in (377.7-600mm)
- Self squaring mounting system and extensions for ID range 7.6-22.6in (193-574mm)
- Dial indicator system
- Operating hand tools
- Storage case
- Manual



Facing tool insert holder (high range)

EP 424 Form Tooling - Facing Holders & Inserts

DESCRIPTION	INCLUDES	PART #
Facing tool insert holders, axial		
Facing tool insert holder (low range)	<ul style="list-style-type: none"> • 1 tool holder (56-198-01) • 2 insert screws (56-190-00) • 1 wrench (56-191-00) 	56-708-01
Facing tool insert holder (high range)	<ul style="list-style-type: none"> • 1 tool holder (56-198-02) • 2 insert screws (56-190-00) • 1 wrench (56-191-00) 	56-708-02
Tool inserts for facing and beveling		
Premium grade HSS insert (2 sided). For facing and beveling. For use with SDB 206, 412 and EP 424 insert holders.		56-711-01
Carbide 2 sided insert. For facing and beveling. For use with SDB 206 and 412 insert holders.		56-712-01
Facing insert holder kit for axial facing and beveling 37.5°		
Insert holder kit for axial facing and beveling 37.5°	<ul style="list-style-type: none"> • 1 low range facing insert holder (56-708-01) • 1 high range facing insert holder (56-708-02) 1 BEVEL INSERT HOLDER 37.5° (56-709-03) FOR SDB, SDB 412 AND EP 424.	56-710-01
Screw and wrench		
Screw, insert		56-190-00
Insert screw torx wrench		56-191-00
Customized tools ground to customer specification (specific Code to be assigned upon receipt of order)		
Custom HSS facing tool bit (form tool)		56-SPT-02
Custom form tool or single point insert holder		56-SPT-10



Premium grade HSS insert (2 sided)

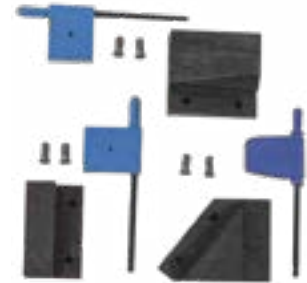

Insert holder kit for axial facing and beveling 37.5°

EP 424 Form Tooling - Bevel Holders & Inserts

DESCRIPTION	INCLUDES	PART #
Bevel tool insert holder kit 30°	<ul style="list-style-type: none"> • 1 holder (56-199-02) • 2 insert screws (56-190-00) • 1 wrench (56-191-00) 	56-709-02
Bevel tool insert holder kit 37.5°	<ul style="list-style-type: none"> • 1 holder (56-199-03) • 2 insert screws (56-190-00) • 1 wrench (56-191-00) 	56-709-03
"J-Prep" bevel tool insert holder kit* 20° (low range)	<ul style="list-style-type: none"> • 1 holder (56-199-01) • 2 insert screws (56-190-00) • 1 wrench (56-191-00) 	56-709-01



Form Tool Insert Holder

*USE WITH 56-708-010 FACING INSERT HOLDER FOR 0.040IN (1MM) LAND EXTENSION.

EP 424 Form Tooling - Bevel Holders & Inserts

DESCRIPTION	PART #
"J-Prep" bevel tool insert holder kit 20° (high range) includes: <ul style="list-style-type: none"> • 1 holder (56-199-05) • 2 insert screws (56-190-00) • 1 wrench (56 191 00) <i>Use with 56-708-01 facing insert holder for 0.040in (1mm) land extension.</i>	56-709-05
Insert holder kit includes: <ul style="list-style-type: none"> • 1 low range facing insert holder (56-708-01) • 1 high range facing insert holder (56-708-02) • 1 bevel insert holder 37.5° (56-709-03) <i>For SDB 206, SDB 412 and EP 424.</i>	56-710-01
Compound bevel form tool 10° x 37.5°	56-707-00
Inserts for facing and beveling	
Premium grade HSS insert (2 sided). <i>For use with SDB 206, 412 and EP 424 insert holders.</i>	56-711-01
Carbide 2 sided insert. <i>For use with SDB 206 and 412 insert holders.</i>	56-712-01
Premium grade HSS 2 sided 32 radius "J" bevel insert. <i>For use with 56-709-01 and 56-709-05 insert holders.</i>	56-711-02
Carbide 2 sided 32 radius "J" bevel insert. <i>For use with 56-709-01 and 56-709-05 insert holders.</i>	56-712-02
Screw and wrench	
Screw, insert	56-190-00
Insert screw torx wrench	56-191-00
Customized tools ground to customer specification	
Custom HSS bevel tool bit single angle (form tool).	56-SPT-01
Custom HSS bevel tool bit compound angle (form tool).	56-SPT-03
Custom HSS bevel tool bit single angle "J" (form tool).	56-SPT-04
Custom HSS bevel tool bit compound angle "J" (form tool).	56-SPT-05



Premium grade HSS insert (2 sided)



Counterbore tool taper 4:1

EP 424 Counterbore & ID Tooling

DESCRIPTION	PART #
ID deburring tools	
ID deburring tool 10° 0.150in (3.81mm) required between mandrel and ID.	56-702-01
ID deburring tool 10° 0.449in (11.4mm) required between mandrel and ID.	56-702-02
ID deburring tool 10° 0.762in (19.4mm) required between mandrel and ID.	56-702-03
Counterbore tools	
Counterbore tool taper 4:1 0.315in (8mm) required between mandrel and ID.	56-705-01
Counterbore tool taper 4:1 0.875in (22.2mm) required between mandrel and ID.	56-705-02
Counterbore tool taper 4:1 1.375in (35mm) required between mandrel and ID.	56-705-03
Counterbore tool taper 4:1 3/8 x 3/8in (9.5 x 9.5mm) Use with single point beveling tool holder.	56-713-00
Counterbore tool taper 4:1 For MDSF 204-SF1420	60-700-04
Tool Holder kit counterbore	56-715-00
Customized tools ground to customer specification	
Custom HSS tool bit ID deburring	56-SPT-06
Custom HSS tool bit counterboring	56-SPT-07



Counterbore tool taper 4:1



Tool Holder kit counterbore

DuoEdge Insert Tooling

E.H. Wachs DuoEdge Insert Tooling is a system of portable machine tool holders and inserts designed to replace larger, more expensive traditional tooling.

It offers considerable cost savings over traditional tooling without sacrificing the longevity of the cutting edge or the quality of the finished prep.

- Multiple cutting edges for minimal work interruption
- Each cutting edge costs on average one third the cost of a traditional bit
- No need to sharpen tooling, saving time, labor and shipping
- Small size of inserts makes them easy to store or carry in your pocket
- Tool Holders are reusable, inserts are interchangeable between holders
- End prep holder is reversible to a high and low range position
- Precision ground, super smooth surface finish
- Reduced friction for longer life
- Chip curl edge designed to clear swarf
- Eliminates expensive and time consuming conventional tool resharping
- Unlike conventional tooling DuoEdge has two cutting edges per insert
- On average costs 1 the price of conventional tooling per edge
- Optimal mix of sharpness and durability
- Supplied with 0.5in tool radius for stronger edges and a better finish
- Superior to competitors off the shelf repurposed CNC tooling

DESCRIPTION	APPLICATION	MATERIAL	PART #
DuoEdge Single Point Holder	Single pointing	Heat treated steel	81-702-00
DuoEdge Insert Single Pack	Carbon steel	HSS	81-701-01
DuoEdge Insert 10-Pack	Carbon steel	HSS	81-701-10
DuoEdge Premium Single Pack	Stainless steel	HSS Premium	81-701-00P
DuoEdge Premium 10-Pack	Stainless steel	HSS Premium	81-701-10P
DuoEdge Insert Single Pack	High-temp alloys	Carbide	81-703-01
DuoEdge Insert 10-Pack	High-temp alloys	Carbide	81-703-10
DuoEdge Insert Single Pack	R 2.4mm/.094in J-Prep	HSS	81-704-01
DuoEdge Insert Single Pack	R 3.2mm/.125in J-Prep	HSS	81-705-01
DuoEdge Insert Single Pack	R 4.8mm/.188in J-Prep	HSS	81-706-01
DuoEdge Insert Single Pack	R 6mm/.236in J-Prep	HSS	81-707-01

EP 424 Single Point Tooling

DESCRIPTION	PART #
Legacy Tool holders	
Single point beveling tool holder, low range. For OD 4.25-23.62in (108-600mm) for EP 424. For EP 424, FF313 and FF424.	56-424-00
Single point beveling tool holder, high range. For OD 7.25-24in (184-609.6mm) for EP 424. For EP 424, FF313 and FF424.	56-424-01
Legacy Tool bit	
Standard HSS tool bit 3/8 x 3/8in (9.5 x 9.5mm). For single point facing, beveling and flange facing. For use with EP 424, LCSF, FF, SWR and SDSF machines.	52-701-01



DuoEdge Tooling Single Point Insert



DuoEdge inserts, 10 pack



DuoEdge Single Point Holder



Legacy single point beveling tool holder

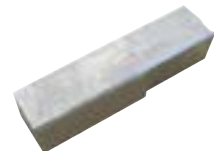

Legacy standard HSS tool bit 9.5 x 9.5mm

SDB Small Diameter Beveler



Box header beveling with SDB



SDB pipe end preparation



SDB end prepping pressure vessel

Fast, Easy Setup - Self-Centering Design

E.H. Wachs SDB line of small diameter bevelers have been engineered for fast, precise onsite facing, beveling, compound beveling and counterboring of light and heavy wall pipe, tube or casing. Proven workhorses, they set up quickly with a self-centering mandrel and chuck assembly mounting to the pipe ID.

Using high strength heat treated steel on the mandrel with aluminum components to save weight without sacrificing strength, one person can setup, operate and create a perfect weld prep in minutes. With optional conversion kits the SDB can be reconfigured to an FF series flange facer.



SDB 103 End Prep

Pipe End Preparation Machines

- Compact, lightweight design for one person set up and operation
- Self-centering ID mandrel assures perfect end preps
- Face, bevel, counterbore
- Convertible to FF series with optional flange facing kit

SDB 103

The SDB 103 end prep handheld beveling machine delivers maximum power and performance for fast, accurate weld preps on pipe and tube from ID 0.875in (22.2mm) to OD 4.5in (114.3mm). Face, bevel and counterbore simultaneously on carbon, stainless and high alloy steels.

Extremely versatile, the SDB 103 allows you to prep boiler tubes, heavy wall pipe, thick wall tubing, and elbows. With optional FF kit face flanges ID 2in (50.8mm) to OD 6in (152.4mm).



SDB 103

SPECIFICATIONS	SDB 103
Machine capacity	0.875in - 4.500in (22.2-114.0mm)
Standard equipment	<ul style="list-style-type: none"> • Heavy duty drive (air or electric) • Standard mandrel ID 1.16-4.18in (29.5-106mm) • 7 sets of leg extensions • Operating hand tools • Watertight storage case • Manual
Shipping weight (est.)	40lb (18kg)
Shipping dimensions (est., without accessories)	25 x 22 x 9in (635 x 558.8 x 228.6mm)

SDB 103 Beveler Kits

DESCRIPTION	DRIVE TYPE	PIPE ID TO OD	PART #
SDB 103	Pneumatic	0.88-4.5in (22-114mm)	16-000-01
SDB 103	Electric 110 V, 50 Hz	0.88-4.5in (22-114mm)	16-000-02
SDB 103	Electric 220 V, 50 Hz	0.88-4.5in (22-114mm)	16-000-03

SDB/FF Flange Facer Conversion Kits for SDB 103

DESCRIPTION	PART #
BEVELER CONVERSION KIT Converts FF 206 to SDB 103 end prep machine to face, bevel, compound bevel and counterbore pipes with Ø 1- 4in (25.4-101.6mm). Includes: <ul style="list-style-type: none"> • 1 standard rotating head • 1 standard mandrel ID 1.16in - 4.18in (29.5-106mm) • 7 sets of leg extensions • 1 felt wiper • Fasteners 	16-420-00
FLANGE FACER CONVERSION KIT Converts SDB 103 to FF 206 flange facing machine for flanges ID 2in (50.8mm) to OD 6in (152.4mm). Includes: <ul style="list-style-type: none"> • 1 single point flange facing tool slide • 1 independent "short perch" mandrel • 7 sets of leg extensions ID 1.95in - 4.11in (49.5-104.4mm) 	16-421-00



SDB to FF Conversion Kit: head, mandrel, legs, & fasteners

SDB 206 End Prep

SDB 206

The SDB 206 makes fast work of end preps on pipe and tube from ID 1.91in (48.5mm) to OD 6.625in (168.3mm). Compact and lightweight, its design requires only 2.25in (57mm) of radial clearance – making it the ideal tool for use in tight places.

No other machine of this type can perform as many different jobs: face, bevel, counterbore (simultaneously if desired), compound bevel and (with optional FF kit) faces flanges from ID 3in (76.2mm) to OD 13in (330.2mm).

SPECIFICATIONS	SDB 206
Machine capacity	1.910in - 6.625in (48.5-168.0mm)
Standard equipment	<ul style="list-style-type: none"> • Heavy duty drive (air, electric or hydraulic) • Standard mandrel ID 2.27-6.58in (57.7-167mm) • 10 sets of leg extensions • Operating hand tools • Watertight storage case • Manual
Shipping weight (est.)	115lb (52kg)
Shipping dimensions (est., without accessories)	12 x 32 x 21in (305 x 813 x 533mm)

SDB 206 Beveler Kits

DESCRIPTION	DRIVETYPE	PIPE ID TO OD	PART #
SDB 206/2	Pneumatic	1.91-6.63in (49-168mm)	56-000-01
SDB 206/2	Electric 110 V, 50 Hz	1.91-6.63in (49-168mm)	56-000-02
SDB 206/2	Electric 220 V, 50 Hz	1.91-6.63in (49-168mm)	56-000-04
SDB 206/2	Hydraulic	1.91-6.63in (49-168mm)	56-000-03

SDB/FF Flange Facer Conversion Kits for SDB 206

DESCRIPTION	PART #
BEVELER CONVERSION KIT Conversion kit FF 313 to SDB 206/6 end prep machine. Includes: <ul style="list-style-type: none"> • 1 standard rotating head • SDB 206 mandrel • 7 sets of leg extensions • 1 felt wiper • Fasteners 	56-420-00
FLANGE FACER CONVERSION KIT Converts model SDB 206/2 to FF 313 flange facing machine. For flanges with ID 3in (76.2mm) to OD 13in (330mm). Includes: <ul style="list-style-type: none"> • 1 single point flange facing tool slide • 3-jaw independent "short perch" mandrel • 18 sets of leg extensions ID 3.00in - 10.08in (76.2-256mm) 	56-421-00



SDB 206



Form tooling to single pointing conversion kit

SDB 412 End Prep

SDB 412

The SDB 412 is a portable pipe end prep machine designed to face, bevel, counterbore (simultaneously) and compound bevel ID 3.80in (96.5mm) to OD 12.75in (323.9mm) pipe, up to 1.125in (29mm) wall thickness.

Face flanges with optional FF kit ID 4in (101.6mm) to OD 24in (609.6mm). The heavy duty yet compact design of the SDB 412 requires minimal operating clearances. The SDB 412 is designed for one person handling, setup and operation.

SPECIFICATIONS	SDB 412
Machine capacity	3.800in - 12.750in (96.5-323.9mm)
Standard equipment	<ul style="list-style-type: none"> • Heavy duty drive (air, electric or hydraulic) • Standard mandrel ID 3.80-12.02in (96.5-305mm) • 8 sets of leg extensions • Operating hand tools • Watertight storage case • Manual
Shipping weight (est.)	308lb (140kg)
Shipping dimensions (est., without accessories)	25 x 47 x 18in (635 x 1.194 x 457mm)

SDB 412 Beveler Kits

DESCRIPTION	DRIVETYPE	PIPE ID TO OD	PART #
SDB 412/2	Pneumatic	3.8-12.75in (97-324mm)	66-000-01
SDB 412/2	Hydraulic	3.8-12.75in (97-324mm)	66-000-03
SDB 412/2	Electric 220 V, 50 Hz	3.8-12.75in (97-324mm)	66-000-02

SDB/FF Flange Facer Conversion Kits for SDB 412

DESCRIPTION	PART #
BEVELER CONVERSION KIT Converts FF 424 to SDB 412/2 portable pipe and tube prepping machine to face, bevel, compound bevel and counterbore pipes with Ø 4in - 12in (102-305mm) Includes: <ul style="list-style-type: none"> • 1 standard rotating head • 1 standard mandrel ID 3.8in - 12.02in (96.5-305mm) • 8 sets of leg extensions • 1 felt wiper • fasteners 	66-420-00
FLANGE FACER CONVERSION KIT Converts SDB 412/2 to FF 424 flange facing machine. For flanges with ID 4in (101.6mm) to OD 24in (609.6mm). Includes: <ul style="list-style-type: none"> • 1 single point flange facing tool slide • 3-jaw independent "short perch" mandrel • 23 sets of leg extensions ID 3.78in - 20in (96-508mm) 	66-421-00

Hydraulic Power Units

For available Hydraulic Power Unit options, see page 74.

Air Control Module

Air Control Module "ACM", see page 72.

Cutting Lubrication

Cutting lubrication "KSS-TOP", see page 51.



SDB 412



Diesel Powered HPU-20



Air Control Module ACM provides remote control for pneumatic operation

FF Flange Facer



Lathe quality surface finish



Based on powerful SDB end prep platform



Convertible to SDB series end prep

Fast, Easy Setup - Self-Centering Design

Now anyone can produce a lathe quality surface finish on flat, raised or recessed face flanges in minutes. Based on the powerful Wachs SDB series ID mount end prep machines, the Wachs FF series flange facers offer a rugged yet lightweight and compact design that allows them to fit into tight quarters.

With the addition of the SDB conversion kit, the FF models can be converted into SDB series machines, allowing them to face, bevel, compound bevel and counterbore. Field proven industry workhorses, they are easy to setup with self-centering mandrels and easy to operate.



FF Flange Facer

Wachs FF series flange facers are based on the powerful and versatile SDB series of bevelers. Simple to operate, they mount to the pipe ID and are self-centering. Specify the SDB conversion kit to add bevel, facing and counterbore capabilities.

- Fast, easy setup – self-centering design
- Simple operation, light-weight and compact
- Record groove, RMS 500, 250, 125
- Converts to SDB beveler series with optional SDB conversion kit

Model FF 206

Flange facing machine for facing flat, raised or recessed face flanges from ID 2in (50.8mm) through OD 6in (152.4mm) up to a 2in (DN50) 150# flange.

Model FF 313

Flange facing machine for facing flat, raised or recessed face flanges from ID 3in (76.2mm) through OD 13in (320.2mm) up to a 6in (DN150) 400# flange.

Model FF 424

Flange facing machine for facing flat, raised or recessed face flanges from ID 4in (101.6mm) through OD 24in (609.6mm)



FF Flange Facer 206



FF Flange Facer 313



FF Flange Facer 424

SPECIFICATIONS	FF 206	FF 313	FF 424
Machine capacity (Pipe ID to OD)	2-6in (50.8-152.4mm)	3-13in (76.2-330.2mm)	4-24in (101.6-609.6mm)
Standard equipment	<ul style="list-style-type: none"> • Heavy duty drive (air or electric) • 3-jaw independent "short perch" mandrel ID 1.95in - 4.11in (49.5-104.4mm) • 7 sets of leg extensions • Single point flange facing tool slide • Tooling package • Watertight storage case • Operating hand tools • Manual 	<ul style="list-style-type: none"> • Heavy duty drive (air, electric or hydraulic) • 3-jaw independent "short perch" mandrel ID 3in - 10.08in (76.2-256mm) • 18 sets of leg extensions • Single point flange facing tool slide • Tooling package • Watertight storage case • Operating hand tools • Manual 	<ul style="list-style-type: none"> • Heavy duty drive (air, electric or hydraulic) • 3-jaw independent "short perch" mandrel ID 3.78in - 20in (96-508mm) • 23 sets of leg extensions • Single point flange facing tool slide • Tooling package • Watertight storage case • Operating hand tools • Manual
Shipping weight*	47lb (21.3kg)	180.8lb (82kg)	
Shipping dimensions* (w/o accessories)	25 x 22 x 9in (635 x 559 x 229mm)	12 x 32 x 12in (305 x 813 x 305mm)	

*ESTIMATED.

MODEL	DRIVETYPE	PIPE ID TO OD	PART #
FF 206	Pneumatic	2-6in (50.8-152.4mm)	16-000-FF
FF 206	Electric 110 V, 50 Hz	2-6in (50.8-152.4mm)	ON REQUEST
FF 206	Electric 220 V, 50 Hz	2-6in (50.8-152.4mm)	ON REQUEST
FF 313	Pneumatic	3-13in (76.2-330.2mm)	56-000-FF
FF 313	Electric 110 V, 50 Hz	3-13in (76.2-330.2mm)	ON REQUEST
FF 313	Electric 220 V, 50 Hz	3-13in (76.2-330.2mm)	ON REQUEST
FF 313	Hydraulic	3-13in (76.2-330.2mm)	ON REQUEST
FF 424	Pneumatic	4-24in (101.6-609.6mm)	66-000-FF
FF 424	Electric 110 V, 50 Hz	4-24in (101.6-609.6mm)	ON REQUEST
FF 424	Electric 220 V, 50 Hz	4-24in (101.6-609.6mm)	ON REQUEST
FF 424	Hydraulic	4-24in (101.6-609.6mm)	66-000-FH
FF 424	SDB 412/2 + FF 424 (Set)	4-24in (101.6-609.6mm)	66-000-04

Mandrels & Accessories for SDB 103

DESCRIPTION	PART #
Standard mandrel. For ID 1.16in - 4.18in (29.5-106mm). Without leg extension sets.	16-303-00
Standard mandrel. For ID 1.16in - 4.18in (29.5-106mm). Includes: 7 sets of leg extensions.	16-409-00
3-jaw independent "short perch" mandrel. For ID 1.95in - 4.11in (49.5-104mm). Includes: 7 sets of leg extensions. Minimum .75in straight run required. To rigid mount on fittings, flanges, elbows and valves.	16-414-00
Small ID accessory mandrel. For ID 0.875in - 1.25in (22-31.75mm). Includes: <ul style="list-style-type: none"> • 1 rotating head 3.13in (79.5mm). • 1/4in (4 x 6.35mm) shank style tool slots. 2 sets of leg extensions for ID mounting ranges: 0.875-1.125in (22-28.6mm) and 1- 1.25in (25.4-31.75mm) • 1 mandrel • 1 drawbar nut • 1 drawbar • Fasteners 	16-401-00



SDB 103 / FF 206
Mandrel Kit

Mandrels & Accessories for SDB 206

DESCRIPTION	PART #
Standard mandrel "new style 2009" For ID 2.27- 2.92in (58-74mm). Without leg extension sets.	56-430-01
Standard mandrel "new style 2009" For ID 2.27in - 6.77in (58-172mm) Includes: 7 sets of leg extensions.	56-430-00
Standard range leg extension kit For standard mandrel "new style 2009". For ID 2.75in - 6.77in (70-172mm).	56-430-02
Upgrade for obsoleted mandrel. Requires return of the 56-401-010 mandrel to complete the upgrade. Estimate for upgrade given for customer approval.	56-310-00
Small ID accessory mandrel. For ID 1.91in - 2.46in (48.5-62.5mm).	56-402-01
Extender kit "new style 2009" for mandrel 56-430-00 Includes: <ul style="list-style-type: none"> • 4 sets of leg extensions for ID 6.71in - 9.04in (170-229.6mm) • 1 rotating head (8in). 	56-407-02
Small 3-jaw independent "short perch" mandrel. For ID 2in - 3.25in (50.8-82.5mm). Includes 3 sets of leg extensions. To rigid mount on fittings, flanges, elbows and valves.	56-416-01
3-jaw independent "short perch" mandrel. For ID 3in - 6.08in (76.2-154mm). Includes 8 sets of leg extensions. Minimum .75in (19.05mm) straight run required. To rigid mount on fittings, flanges, elbows and valves.	56-414-01
Extension adapter hub. For ID 6in - 10.1in (152.4-256.5mm). Includes 10 sets of leg extensions. For 3-jaw independent "short perch" mandrel 56-414-01.	56-415-00
Single point flange facing tool slide. For flanges with ID 3in (76.2mm) to OD 13in (330mm).	56-404-00



SDB 206 / FF 313
Mandrel Kit

Mandrels & Accessories for SDB 412

DESCRIPTION	PART #
Standard mandrel. For ID 3.80-12.02in (96.5-305mm). Excludes leg extension sets.	66-301-01
Standard mandrel. For ID 3.80-12.02in (96.5-305mm). Includes 8 sets of leg extensions.	66-407-01
3-jaw independent "short perch" mandrel. For ID 3.75-12.80in (95-325mm). Includes 13 sets of leg extensions. Minimum .75in straight run required. To rigid mount on fittings, flanges, elbows and valves.	66-414-01
Extension adapter hub. For ID 12.72-20in (323-508mm). Includes 10 sets of leg extensions. For 3-jaw independent "short perch" mandrel 66-414-01.	66-415-00
Leg set replacement Includes: • 3 chuck legs (66-084-00) • 1 complete set of extension leg assemblies from 0.5-4in (12.7-101.6mm)	66-411-00



SDB 412 / FF 424 Mandrel Kit

Facing/Beveling/Counterboring Tools for SDB 103

DESCRIPTION	PART #
FF Flange facing tool insert holder.	56-714-01
FF Flange facing tool insert for holder (56-714-01). Carbide.	60-702-00
Facing tool (non-wedgelock) for ID 1.16-3in (29.5-76.2mm).	26-410-02
Facing tool (non-wedgelock) for ID 2.3-4.18in (58.4-106mm).	26-410-03
Facing tool (non-wedgelock) Carbide tipped. Max. wall 0.75in (19.05mm).	26-410-04
Custom HSS facing tool bit (non-wedgelock). Ground to customer specification.	26-SPT-01
Bevel tool 37.5° (non-wedgelock). For ID 1.16-3in (29.5-76.2mm).	26-411-01
Bevel tool 37.5° (non-wedgelock). For ID 2.3-4.18in (58.4-106mm).	26-411-02
Bevel tool 37.5° (non-wedgelock). For ID 2.14-2.7in (54.4-68.6mm).	26-411-03
Bevel tool carbide 37.5° (non-wedgelock).	26-411-04
Bevel tool bit 20° "J" 32 radius (non-wedgelock). For ID 1.35-4in (34.3-101.6mm). Use with facing tool 26-410-02 for 0.03in (0.76mm) land extension.	26-713-00
Custom HSS single angle bevel tool bit (non-wedgelock). Ground to customer specification.	26-SPT-02
Custom HSS "J-Prep" bevel tool bit (non-wedgelock). Ground to customer specification.	26-SPT-06
Universal beveling and facing tool 37.5° (non-wedgelock). For ID 1.5-3in (38.1-76.2mm).	26-413-01
Universal beveling and facing tool 37.5° (non-wedgelock). For ID 2.2-3.8in (55.9-96.5mm).	26-413-02
Custom HSS combination facing and beveling tool bit (non-wedgelock). Ground to customer specification.	26-SPT-04
Small ID deburring tool (non-wedgelock). 0.186in (4.7mm) required between mandrel and ID.	26-412-01
Medium ID deburring tool (non-wedgelock). 0.43in (10.9mm) required between mandrel and ID.	26-412-02
Large ID deburring tool (non-wedgelock). 0.68in (17.3mm) required between mandrel and ID.	26-412-03
Combo 30° taper counterbore and facing tool (non-wedgelock) 0.326in (8.3mm) required between mandrel and ID.	26-426-00
Custom HSS ID deburring tool (non-wedgelock). Ground to customer specification.	26-SPT-03
Custom HSS counterboring tool bit (non-wedgelock). Ground to customer specification.	26-SPT-05



Medium ID deburring tool (non-wedgelock)



Bevel tool 37.5° (non-wedgelock)



32 radius 2-sided "J-Prep" bevel tooling insert (Premium)

Facing and Beveling Tools for SDB 206 & SDB 412

DESCRIPTION	PART #
Facing tool insert holder (low range) includes: <ul style="list-style-type: none"> • 1 holder (56-198-01) • 2 insert screws (56-190-00) • 1 wrench (56-191-00) 	56-708-01
Facing tool insert holder (high range) includes: <ul style="list-style-type: none"> • 1 holder (56-198-02) • 2 insert screws (56-190-00) • 1 wrench (56-191-00) 	56-708-02
Premium grade HSS insert (2 sided). For facing and beveling. For use with SDB 206, SDB 412 and EP 424 insert holders.	56-711-01
Carbide 2 sided insert. For facing and beveling. For use with SDB 206 and SDB 412 insert holders.	56-712-01
Insert holder kit includes: <ul style="list-style-type: none"> • 1 low range facing insert holder (56-708-01) • 1 high range facing insert holder (56-708-02) • 1 bevel insert holder 37.5° (56-709-03) For use with all SDB 206, SDB 412 and EP 424.	56-710-01
Custom HSS facing tool bit (form tool). Ground to customer specification.	56-SPT-02
Custom facing insert holder. Ground to customer specification.	56-SPT-09
30° bevel tool insert holder kit includes: <ul style="list-style-type: none"> • 1 holder (56-199-02) • 2 insert screws (56-190-00) • 1 wrench (56-191-00) 	56-709-02
Bevel tool insert holder kit 37.5° includes: <ul style="list-style-type: none"> • 1 holder (56-199-03) • 2 insert screws (56-190-00) • 1 wrench (56-191-00) 	56-709-03
"J" bevel tool insert holder kit 20° (low range) includes: <ul style="list-style-type: none"> • 1 holder (56-199-01) • 2 insert screws (56-190-00) • 1 wrench (56-191-00) Use with facing insert holder 56-708-01 for .04in (1mm) land extension	56-709-01
"J" bevel tool insert holder kit 20° (high range) includes: <ul style="list-style-type: none"> • 1 holder (56-199-05) • 2 insert screws (56-190-00) • 1 wrench (56-191-00) Use with facing insert holder 56-708-10 for .04in (1mm) land extension	56-709-05
Premium grade HSS insert (2 sided). For facing and beveling. For use with SDB 206, SDB 412 and EP 424 insert holders.	56-711-01
Premium grade HSS insert (2 sided) 32 radius "J" bevel insert. For use with 56-709-01 and 56-709-05 holders.	56-711-02
Carbide insert (2 sided). For facing and beveling. For use with SDB 206 and SDB 412 insert holders.	56-712-01
Carbide insert (2 sided) 32 radius "J" bevel. For use with 56-709-01 and 56-709-05 insert holders.	56-712-02
Compound bevel form tool 10° x 37.5°.	56-707-00
Insert holder kit includes: <ul style="list-style-type: none"> • 1 low range facing insert holder (56-708-01) • 1 high range facing insert holder (56-708-02) • 1 bevel insert holder 37.5° (56-709-03) For use with SDB 206, SDB 412 and EP 424.	56-710-01
Legacy single point beveling tool holder. For EP 424, FF 313 and FF 424, low range. EP 424 for OD 4.25in - 23.62in (108-600mm).	56-424-00



Facing tool insert holder (high range)



Bevel tool insert holder kit 37.5°



Premium grade HSS insert (2 sided)

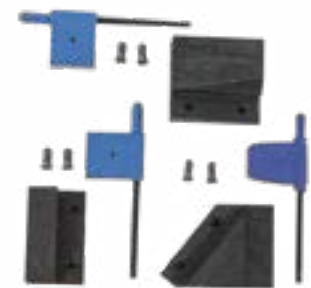

Insert Holder Kit 56-710-01

Beveling & Counterboring Tools for SDB 206 & SDB 412

DESCRIPTION	PART #
Legacy single point beveling tool holder. For EP 424, FF 313 and FF 424, high range. EP 424 for OD 7.25in - 24in (184-609.6mm)	56-424-01
Custom HSS single angle bevel tool bit (form tool). Ground to customer specification	56-SPT-01
Custom HSS compound angle bevel tool bit (form tool). Ground to customer specification	56-SPT-03
Custom single angle "J" bevel tool bit (form tool). Ground to customer specification	56-SPT-04
Custom HSS compound angle "J" bevel tool bit (form tool). Ground to customer specification	56-SPT-05
Custom bevel angle insert holder. Ground to customer specification	56-SPT-08
10° ID deburring tool. 0.15in (3.8mm) required between mandrel and ID	56-702-01
10° ID deburring tool. 0.449in (11.4mm) required between mandrel and ID	56-702-02
10° ID deburring tool. 0.762in (19.4mm) required between mandrel and ID	56-702-03
4:1 Taper counterbore tool. 0.315in (8mm) required between mandrel and ID	56-705-01
4:1 taper counterbore tool. 0.875in (22.2mm) required between mandrel and ID	56-705-02
4:1 taper counterbore tool. 1.375in (35mm) required between mandrel and ID	56-705-03
Custom HSS ID deburring tool bit. Ground to customer specification	56-SPT-06
Custom HSS counterbore tool bit. Ground to customer specification	56-SPT-07



Legacy single point beveling tool holder



Legacy standard HSS tool bit
9.5 x 9.5mm

Flange Facing Tools for FF 206

DESCRIPTION	PART #
Carbide insert. For beveling and flange facing For use with insert holder 56-714-01	60-702-00
Carbide insert tool holder kit For single point beveling and flange facing includes: <ul style="list-style-type: none"> • 1 holder (16-042-00) • 1 flag wrench (56-191-00) • 2 retaining screws (60-231-01) • 5 inserts (60-702-00) 	16-701-00

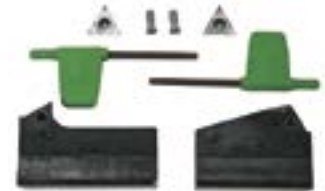

Flange facing tool kit

Flange Facing Tools for FF 313 & FF 412

DESCRIPTION	PART #
Flange facing tool kit includes: <ul style="list-style-type: none"> • 1 low range insert tool holder (56-195-00) • 1 high range insert tool holder (56-194-00) • 2 tool inserts (56-710-00) • 2 insert retaining screws (56-190-00) • 1 screw wrench (56-191-00) 	56-418-01
Tool insert for flange facing (high and low range)	56-710-00
Custom form tool or single point insert holder. Ground to customer specification	56-SPT-10



Flange facing tool insert

Hydraulic Power Units

For available Hydraulic Power Unit options, see page 74.

Air Control Module

Air Control Module "ACM", see page 72.



Pneumatic straight and right angle 6B spline drive motors



Powerful HPU-20 with standard remote control pendant



Eibenstock HD available with or without remote control

Power Delivery Solutions for Pipe Cutting & Beveling

E.H. Wachs offers a wide variety of power drive motor options including electric, hydraulic and pneumatic. All Wachs machine tools require a smooth, controllable power source, essential to produce the precision weld preps needed for high quality, repeatable welds.

Many Wachs machines can be operated with multiple drive types, while others are designed for a single or specialized drive type. Whichever machine you purchase or rent, OD or ID mounted, Wachs has the optimum power solution for your application.



ACM Air Control Module with Remote Control For MDSF, SDSF, EP 424, & SDB/FF Series

E.H. Wachs Air Control Module (ACM) is two accessories in one, an ATM Air Treatment Module that regulates and conditions the incoming air supply to protect valuable air motors, and a remote control device that allows the operator the freedom to move away from the machine. The ACM allows operators to cut and bevel pipe up to 7.9m (26feet) away, significantly reducing fatigue while moving the operator a safer distance from the workpiece, important in highly restricted or potentially hazardous environments.

- All air design, with no other power source required
- Compact, self contained; controls and hoses go in the strong, watertight case
- Lockable case with wheels and telescoping handle for easy transport
- Lightweight, ergonomic remote for operator comfort
- 1.8m (6 foot) remote umbilical provides the operator unencumbered movement and optimum positioning
- Pressure regulator locks at desired pressure; 116psi (8 BAR) maximum setting
- Dual unit pressure gauge for quick visual confirmation of supply pressure
- Vented non-marring quick disconnect with easy push to connect and one handed disconnection
- Durable 6m (20 foot) air line for any operating position and improved safety

Easy Operation

Everything needed to quickly set up and start operating remotely is contained inside the case. The ACM uses the large "Chicago" style air coupler for our split frame and end prep machines, and includes the required adapters to control the SDSF and other machines that use a smaller air connector.

Safety Features

- Lockable shut-off for supply isolation
- Pressure relief system
- Shut-off vents trapped system pressure
- Emergency stop shuts off and dumps air motor supply
- Operator reset required following main pressure failure or emergency stop activation, preventing dangerous movement

Specifications

- **Air Power Requirements:**
ACM - 1.84m³/min at 6.3 BAR (65cfm; 90-232psi) compressed air supply
- **Packaging:** Heavy duty storage case, transport with handle and wheels
- **Dimensions:** 457 x 500 x 305mm (18.0 x 19.7 x 12.0in)
- **Materials:** Ultra high-impact copolymer resin case & steel control panel
- **Weight:** 15.4kg (34lb)

Standard Equipment

- Integrated control module
- 1.8m (6ft) remote cord
- 6m (20ft) air hose
- Remote hand controller
- Heavy Duty Transport/Storage Case
- Operating Instructions

ITEM	RENTAL #	PART #
ACM Air Control Module for pneumatic motors	R69-4101-01	69-4101-01



Air Control Module ACM
for pneumatic motors



Ergonomic fingertip control
with safety stop button



ACM controlling Split Frame

ATM Air Treatment Modules

Pneumatic power is the first choice of most field machinists, but untreated air can be rough on even the toughest air motors. Strongly recommended, Wachs ATM Air Treatment Modules condition and regulate incoming air, extending motor life.

DESCRIPTION	PART #
ATM Air Treatment Module (Non-CE)	26-407-00
ATM Air Treatment Module for DynaPrep MDSF	69-4100-00
ATM Air Treatment Module Remote for DynaPrep MDSF	69-4101-00

Pneumatic Drive Motors

Wachs offers a broad range of pneumatic, hydraulic and electric drive motor options with the power and durability for form tooling, single pointing and other cutting uses.

DESCRIPTION	PART #
Pneumatic Right Angle Drive Motor w/Speed Control, Chicago Fitting, and ACM Air Control Module	69-5454-00
Pneumatic Right Angle Drive Motor w/Control Handle, Speed Control, Chicago Fitting, and ATM Air Treatment Module	69-5452-00
Pneumatic Right Angle Drive Motor w/Control Handle, Speed Control, Oiler, Filter, and Chicago Fitting	69-5450-00
Pneumatic Straight Drive Motor w/Speed Control, Chicago Fitting, and ACM Air Control Module	69-5455-00
Pneumatic Straight Drive Motor w/Control Handle, Speed Control, Chicago Fitting, and ATM Air Treatment Module	69-5453-00
Pneumatic Straight Drive Motor w/Control Handle, Speed Control, Oiler, Filter, and Chicago Fitting	69-5451-00
Pneumatic Reversible Right Angle Drive Motor w/Handle	69-4353-01

DynaPrep MDSF Pneumatic Meter-Out Kits

Meter-out kit consisting of exhaust manifold, speed control, and muffler. Controls (meters) the airflow on the exhaust (out) side to yield high torque, low rpm operation for high alloy materials like stainless steel and Inconel. Where extra torque and precise speed control at slow speeds is required, consider a meter-out kit for your air motor. It is the ideal upgrade for machining stainless steel and other corrosion resistant alloys.

DESCRIPTION	PART #
Straight Drive Meter-Out Adapter Kit	69-4366-00



Air Treatment Module ATM



Pneumatic drive motors are available in straight & right angle models



Straight Drive Meter-Out Adapter Kit

POWER Hydraulic

Hydraulic Power Units

Gasoline HPU Model HCM-2G (14-000-08)

11 HP Honda gasoline engine driven hydraulic cart mounted power unit, with electric start, hour meter, spark arrestor, low oil level shut down and oil cooler.

Rated for 10 GPM @ 1500 PSI (37.9 LPM @ 103 BAR)

Diesel HPU Model HCM-D23 (14-000-33)

23 HP diesel engine driven hydraulic cart mounted power unit, with electric start, hour meter, fuel gauge, spark arrestor, low oil level shut down and oil cooler. Rated for 15 GPM @ 1800 PSI (56.8 LPM @ 124 BAR)

Electric HPU Model HCM-3E4-50 (14-000-28)

15 HP 415-440V 50Hz (IP44 rated) 3 phase electric motor driven hydraulic cart mounted power unit, with electric motor switch and oil cooler.

Rated for 15 GPM @ 1500 PSI (56.8 LPM @ 103 BAR)

Electric HPU Model HCM-3E3-50 (14-000-29)

15 HP 380V 50Hz (IP44 rated) 3 phase electric motor driven hydraulic cart mounted power unit, with electric motor switch and oil cooler.

Rated for 15 GPM @ 1500 PSI (56.8 LPM @ 103 BAR)



Cart Mounted, Gasoline Fueled Hydraulic Power Unit



Diesel D23 Hydraulic Power Unit



Electric Hydraulic Power Unit

Hydraulic Hose Set & Accessories

DESCRIPTION	PART #
45 foot - 1/2in Hydraulic Hose Set W/Quick Disconnects (Not for use with Trav-L-Cutter Model HE)	03-404-00
45 foot - 5/8in Hydraulic Hose Set including 4 sets M/F Quick Disconnects. (For use with Trav-L-Cutter Model HE)	02-408-00
20 Foot - 1/2in Hydraulic Hose Set	09-406-00
Female Hydraulic Disconnect (1)	09-025-00
Male Hydraulic Disconnect (1)	09-026-00

MODEL	ENGINE	GPM/LPM	FRAME TYPE	OIL COOLER	FUEL	HYD OIL (USABLE)	HYD RELIEF PRESSURE	FILTRATION	LENGTH	WIDTH	HEIGHT	WEIGHT
HCM-2G	11HP Gas	7 GPM (26 LPM)	Cart Mount	None	1.6 GAL (6.1 LTR)	5.0 gal (19 ltr)	1500 PSI (103 BAR)	10 MICRON RETURN LINE CANISTER TYPE	26.5in (67cm)	20in (51cm)	27.5in (70cm)	143lb (65kg)
HCM-3E4	15HP Electric	15 GPM (57 LPM)		Air to Oil with Fan	N/A	4.0 gal (15.4 ltr)			27.5in (70cm)	24.5in (62cm)	31.5in (80cm)	200lb (90kg)
HCM-3E3				Air to OIL	5.0 GAL (18.9 LTR)	5.0 gal (19 ltr)	1800 PSI (124 BAR)		39in (99cm)	29in (73.7cm)	36.5in (93cm)	520lb (236kg)
HCM-D23	23HP Diesel											
HPU-20	20HP Electric	18 GPM (68 LPM)	Trolley Mount	Air to OIL	N/A	30 gal (114 ltr)	1500 PSI (103 BAR)		46.5in (104cm)	21in (53.3cm)	28in (71cm)	850lb (195kg)
HSM-SQ	15HP Electric	15 GPM (57 LPM)	Skid			5.0 gal (19 ltr)	1500 PSI (103 BAR)		43.7in (110cm)	31.5in (80cm)	56.3in (143cm)	CONSULT FACTORY

Heavy Duty Electric Model HPU-20 (14-000-35)

380-480v Electric Motor Driven Remote Controlled Hydraulic Power Unit.

Standard Features

- UL Listed NEMA 4 Electrical Controls Power (50/60HZ 3 Phase)
- 380-480V 3 phase input power
- Over temp shut off
- Low oil light
- Remote pendant control with a 12 ft and a 50 ft extension cable
- Remote stop / start and flow control
- Removable base with non-marring casters
- Five (5) point rigging / lifting system
- Heat exchanger complete with digital readout
- Ultra quiet helical hydraulic gear pump
- Powder coat finish
- Operating manual

Specifications

- 52.5in H x 26in W x 34.75in L
- 20HP 3 phase electric motor
- 30 gal tank capacity
- 850lb operating weight with base & hydraulic oil
- Factory Pressure Relief Setting 1800 psi (124 BAR)
- Variable Flow from 4-18 GPM (15-68 l/min)
- Electric Power Requirements 380-480v (3 Phase) 50/60Hz @ 30 Amps
- Sound level 62db at full flow
- HPU is shipped without Hydraulic Oil.

Hydraulic Drive Motors

Ideal for full or partial immersion. Tool-free connection allows the motor's 6B spline drive and face gear to slide into place, providing fast setup. Available models include with Flow Control for cart HPU use and without Flow Control for pendant equipped HPU-20.

DESCRIPTION	PART #
MDSF Hydraulic Drive Motor With Flow Control	69-4358-00
MDSF Hydraulic Drive Motor for HPU 20 without Flow Control	69-4363-01
EP 424 Hydraulic Drive Motor	81-310-00
SDB / FF Hydraulic Drive Motor	56-413-03

Electric Drive Motors

German manufactured Eibenstock electric drives represent the pinnacle of precision electric drive motors. These HD drive motors are compact yet powerful, and matched to drive select DynaPrep MDSF Split Frames. In addition they can be used to power SDB 206 and 412 end preps plus FF 313 and 424 flange facers. Smooth, quiet, and powerfully efficient they pack a large amount of power in a relatively compact package. Available with machine control, remote control pendant or full remote control pendant and trip in 110V and 220V models.

DESCRIPTION	PART #
Eibenstock HD Electric Drive-110V, MDSF	69-4340-00
Eibenstock HD Electric Drive-220V, MDSF	69-4341-00
Eibenstock HD Electric Drive-110V with remote pendant (requires controller box)	69-4342-00
Eibenstock HD Electric Drive-220V with remote pendant (requires controller box)	69-4343-00
Eibenstock HD 110v with remote pendant, electric remote trip, controller box	69-4344-00
Eibenstock HD 220v with remote pendant, electric remote trip, controller box	69-4345-00
Eibenstock Drill-style Electric Drive Assembly-110V	SPG-489-4110
Eibenstock Drill-style Electric Drive Assembly-220V	SPG-489-4220



Heavy Duty Electric HPU-20



Hydraulic Drive Motor without flow control for use with HPU-20



Hydraulic drive motor



Provides electric power with remote control options available

Choosing the Best Drive Option

E.H. Wachs offers a wide variety of power drive options, including pneumatic, hydraulic and electric. Here are a few things to consider when selecting the appropriate drive for your application.

Pneumatic Power

Pneumatic is the most popular choice due to the wide availability of compressed air, and offers good power characteristics and controllability. Where extra torque is desired consider a meter-out kit for your air motor.

Hydraulic Power

Hydraulic power is the most uniform across a given power range, regardless of the rpm of the machine tool. It is a clean, sealed power source ideal for use in hostile environments including airborne salt spray, sand, and partial or full immersion in mud or water.

Electric Power

The best choice where airborne or fluid contamination is highly undesirable, such as in high purity and power generation applications is electric power. Remote control with and without remote trip are available in 110v and 220v models.

Remote Control

E.H. Wachs offers remote control options available for all three drive types.



Pneumatic drive motors



Hydraulic drive motors with flow control

Drive Motor Torque Comparison Electric, Pneumatic, & Hydraulic Drive

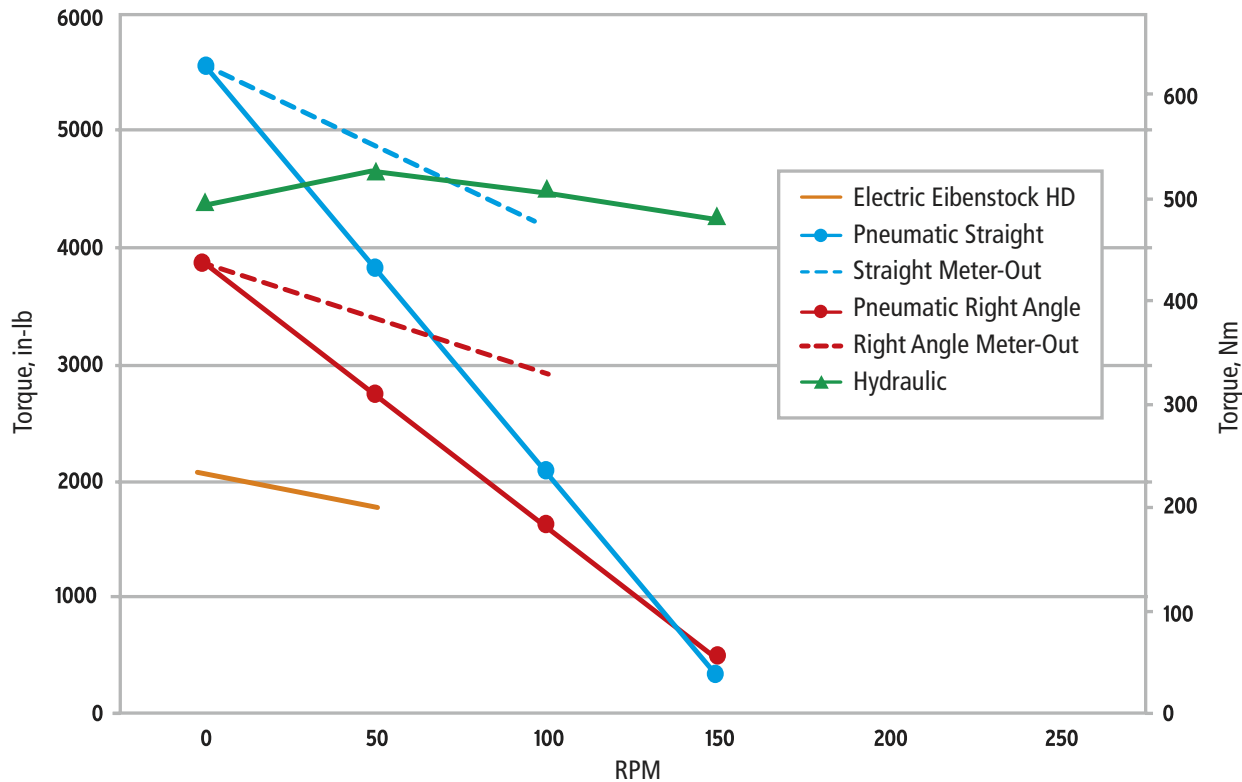

ALTHOUGH INITIALLY PROVIDING MORE TORQUE AT SLOW SPEEDS PNEUMATIC DRIVE SHOWS A REDUCTION IN TORQUE WITH AN INCREASE IN SPEED. HYDRAULIC POWER IS THE MOST UNIFORM ACROSS A GIVEN SPEED RANGE.

SPECIALTY Machines

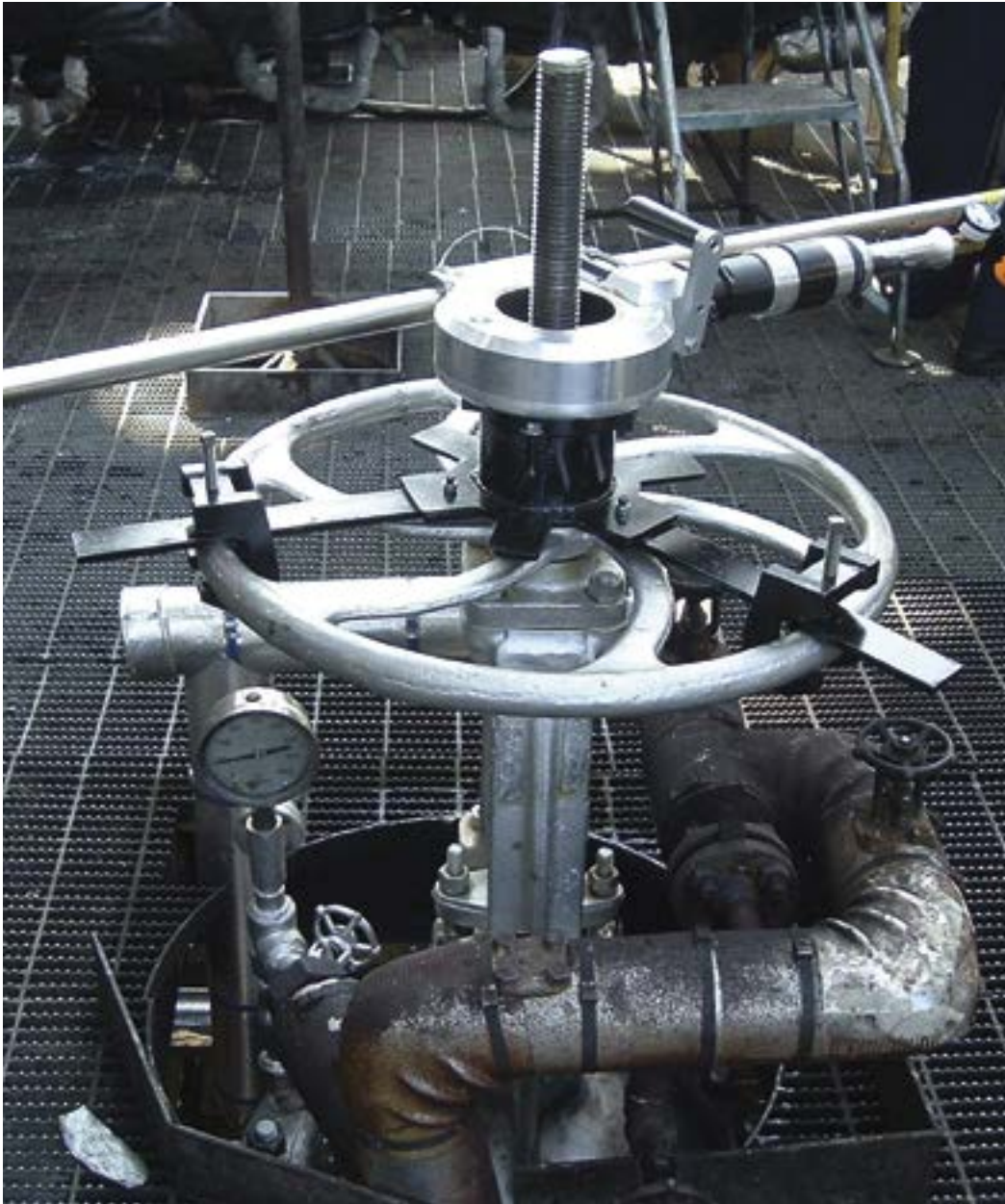

Weld coupon loaded, ready for prep



Weld Coupon Station



RS-2 Rising Stem Valve Exerciser

Special Jobs Call for Special Machines

E.H. Wachs has a long history of creating specialized machines for unique or challenging machining tasks. Our RS-2 and P-2 handheld operators are the ideal tool for operating or exercising handwheel and rising stem valves, and are available in three drive types. The P-2 is offered in your choice of high torque or high speed models.

Wachs Weld Coupon Station is specially designed for training organizations to teach end prep beveling skills while saving and reusing practice coupons. Genuine Wachs tooling is available in both Legacy style and DuoEdge holder and insert, which offers one of the lowest costs per cut in the industry. If you need help with a difficult machining project contact your local E.H. Wachs representative – we probably have a tool for the job.



RS-2 Valve Operator

Rising Stem Valve Turning & Operation

Turning valves and valve handwheels is an important job for maintaining pipeline infrastructure. An organization can have hundreds or even thousands of valves that must be controlled, or in some industries "exercised", the process of running a valve through its full cycle to prevent sticking or freezing caused by factors such as tuberculation.

The RS-2 (Rising Stem 2) Portable Valve Operator for rising and non-rising stem valves delivers up to 800lb-ft torque and a maximum of 55rpm for fast, reliable opening and closing of water, wastewater, pipeline and petro-chemical valves.

Highly Versatile

The RS-2, designed with operator health in mind, spares arm and back injuries associated with manually turning large, stubborn or frozen industrial valves. The RS-2 offers a range of adapters and accessories to suit most applications, including PIV (Post Indicator Valves). There's a 1in (25.4mm) square drive adapter, dedicated handwheel adapters and a universal handwheel adapter to fit most common handwheels.

Multi-Functional Valve Operator

- Available in hydraulic, pneumatic or electric Drive
- Operate all rising & non-rising stem valves from 6-60in (152.4-1524mm)
- 4in (106.1mm) hub opening for operating rising stem valves
- Mount to any handwheel with Universal Handwheel Adapter
- Forward and reverse operation. Variable speed control
- Built in easy view LCD counter
- 55rpm high-speed operation for valves requiring several hundred turns
- 800lb-ft torque for difficult valves

Available Models

DRIVE TYPE	POWER REQUIREMENTS	MOTOR CONTROLS	PART #
Pneumatic	60cfm @ 90psi	Variable speed; Forward and reverse dial	78-000-03
Electric	110volt AC (15amps or 3500 watt generator)	Variable speed; Adjustable torque control Forward and reverse control valve	78-000-01
Hydraulic	8gpm @ 1800psi	Variable speed; Adjustable torque control Forward and reverse control valve	78-000-04

RS-2 Handwheel Adapter

For using the rising stem valve operator with standard handwheels.

MODEL	PART #
RS2 Dedicated Handwheel Adapter - Stays on handwheel for quick operation	P13-017-4007-00
RS2 Universal Handwheel Adapter	P13-017-4008-00



RS2 Dedicated Handwheel Adapter P13-017-4007-00



RS2 Universal Handwheel Adapter P13-017-4008-00



RS2 Rising Stem Valve Operator electric model shown



RS2 with Handwheel Adapter



RS2 operating rising stem valve



Allows for 2-person operation

P-2 Valve Operator

Handheld High Speed or High Torque Valve Operation

E.H. Wachs® powered handheld valve turners/operators are built for quick operation and exercising of valves. Available in pneumatic, hydraulic and electric drive the P-2 is powerful and highly portable for quick, efficient operation of most valves, handwheel valves and post indicator valves (PIV).

The E.H. Wachs® P-2 (Pow-R-Drive 2) handheld valve turning machine is the ideal solution for organizations dealing with critical valves of any sort, including fire prevention and water material handling systems. It's lighter, faster and more powerful than any other machine of its kind and helps eliminate arm and back injuries associated with attempting to manually turn large or stuck valves.

The P-2 offers increased productivity, operator efficiency and valve protection. It's compact size and light weight make it the perfect tool for hard to reach valves, valve turning/exercising and fast shut downs, delivering controlled power to operate valves 6" (152.4mm) and up.

The P-2 is available in both high speed HS and high torque HT models, in pneumatic, hydraulic, or electric drive. An optional universal handwheel adapter allows the P-2 to operate non-rising stem handwheels.

P-2 Features

- Lightweight, rugged construction
- Easy setup and operation
- Convenient finger tip control
- LCD counter, VITALS compatible
- VITALS offers precise torque control
- Pneumatic, hydraulic or electric

Available Models

DRIVE TYPE	TORQUE	SPEED	PART #
Electric 110V	500 ft-lb	20 rpm	11-000-07
Electric 220V	500 ft-lb	20 rpm	11-000-10
Pneumatic	500 ft-lb	26 rpm	11-000-08
Hydraulic	500 ft-lb	24 rpm	11-000-09
Electric 110V	500 ft-lb Vitals torque control	20 rpm	11-000-17
Electric 220V	500 ft-lb Vitals torque control	20 rpm	11-000-20
Hydraulic	500 ft-lb Vitals torque control	20 rpm	11-000-19
Electric 110V	800 ft-lb	10 rpm	11-000-02
Electric 220V	800 ft-lb	10 rpm	11-000-05
Pneumatic	800 ft-lb	13 rpm	11-000-03
Hydraulic	800 ft-lb	12 rpm	11-000-04
Electric 110V	800 ft-lb Vitals torque control	10 rpm	11-000-12
Electric 220V	800 ft-lb Vitals torque control	10 rpm	11-000-15
Hydraulic	800 ft-lb Vitals torque control	12 rpm	11-000-14

P-2 Handwheel Adapter

Size adjustable solution for using the P-2 with Standard Handwheels

MODEL	PART #
P-2 Handwheel Adapter	11-401-00

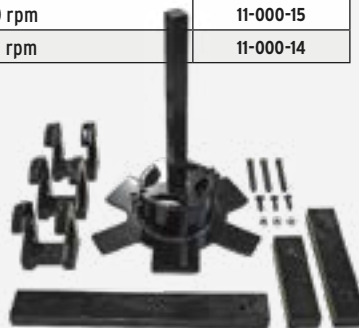

P-2 Handwheel Adapter



P-2 Electric 110V Model



P-2 Pneumatic Model



P-2 Hydraulic Model



Vitals torque control available on select models.



P-2 Electric shown with Handwheel Adapter

WELD Coupon Station

Save Thousands Making Your Own Coupons

E.H. Wachs Weld Coupon Station is a self contained tool designed for machining weld preps onto ordinary pre-cut pipe sections, creating weld ready coupons. Wachs Coupon Station will machine virtually any prep including bevels, compound bevels and J-preps on carbon steel, stainless steel, alloy steel and aluminum pipe and tubing. It is available in two models, Basic and Deluxe.

The Basic model includes the standard mandrel to satisfy a 2.75in OD coupon. The deluxe model includes the optional mandrel assembly to counterbore from 2.26in to 6.63in ID (57.4 - 168.4mm). It's capable of handling all common coupon sizes up to "Super Coupons" with 2.75in OD (69.9mm) and 5/8in wall (15.9mm) and up to a 6in (DN150) schedule 80.

Save Your Coupons

Wachs Coupon Station will quickly pay for itself in time and material savings. For example, if you purchased and discarded 2,000 coupons per year at the current average cost of \$10 each, by using the Prep Station you'd save nearly \$20,000 and enjoy an extremely rapid return on your investment. Order your Weld Coupon Station today and you'll see that with Wachs, it pays to save your coupons.

Coolant System

Designed to mount on a bench or cart, the Coupon Station is built around E.H. Wachs powerful SDB 206/2 ID mounted machine tool, the finest of its kind. A totally self contained unit, it features a clear splash proof enclosure with a recirculating coolant system that dramatically extends tooling life.

A screened chip collection tray protects against coolant contamination. Safe, clean and easy to use the Weld Coupon Station features precision external controls to effortlessly make the perfect weld prep in minutes.

Specifications

Machining Capacity: Common coupon sizes up to "Super Coupons" with 2.75in (69.9mm) OD and 5/8in wall (15.9mm) using included mandrel; with optional accessories up to 6in Schedule 80 (ND150)*

Feed Rate: .083in (2.1mm) per revolution

Feed Stroke: 2.5in (63.5mm) usable feed travel w/ .001in (.025mm) feed scale

Chucking Capacity (ID):

2in (50.8mm) pipe schedule 10, 40, 80, xx, super coupon

Controls:

On/Off, Manual Clamp, Manual Feed, E-Stop, Speed & Coolant Shut-Off

Drive: Electric 110V/AC @ 15 Amp - 60Hz

Tooling: Included 37.5° tooling holder kit, Genuine Wachs 56-711-01 high speed steel tooling with 2 precision ground cutting edges

Dimensions:

Length 21in (533.4mm) x Width 18in (457.2mm) x Height 21in (533.4mm)

Weight: Without coolant 105lb (47.6Kg)



Weld Coupon Station



Weld Coupon Station uses coolant for extended tool life



Controls are externally mounted and grouped together for convenience.



The heart of the Weld Coupon Station is the Wachs SDB 206 Beveler

MODEL	PART #
Weld Coupon Station	P08-089-401
Deluxe Range Extender	P08-089-402

GENUINE Wachs Tooling

Better Value

Genuine Wachs Tooling offers better value than imitation or universal tooling. Made specifically for E.H. Wachs machine tools, they fit perfect, hold an edge longer and can be resharpened multiple times. They deliver the precision finishes at speeds you expect from E.H. Wachs equipment. Work stoppages from inexpensive tooling are only part of the reason Wachs tooling is the better value.

The tooling material selected is as important as the profile in delivering a superior machined surface. We have decades of experience manufacturing the best performing, longest lasting tooling for our machines.

Illustrated here are the basic types offered, simplified for clarity. Wachs offers an extensive lineup of tooling, bits and blades for most applications. To maintain the peak performance of your Wachs machines, always specify Genuine Wachs Tooling.

Precisely engineered and fabricated with superior high-strength materials, Wachs tooling is designed for today's higher speeds, heavier feed rates, and exotic materials. The result is precise cuts, longer tooling life and maximum productivity.

DuoEdge™ Holder & Insert System



For the lowest cost-per-cut specify DuoEdge Tooling (where applicable).

BLADES	OD MOUNT BITS	ID MOUNT BITS
SLITTING	INSIDE BEVEL	SINGLE POINT TAPER
OD BEVEL	OUTSIDE BEVEL	COUNTERBORE
RECIPROCATING	DOUBLE BEVEL	COMPOUND BEVEL
	PARTING	BEVEL, INSERT
		SINGLE POINT, INSERT

Custom Tooling

While Genuine Wachs Tooling works for many applications, we understand the need for custom tooling for specific applications and needs that arise in the field.

Please provide as much information possible about the project regarding customized tooling for manufacturing to spec for the best results.

Single Bevel

Required	T
OD	Lt
ID	B1

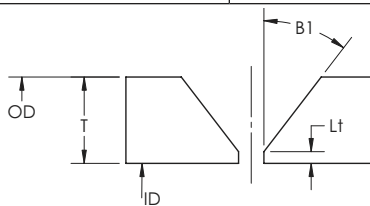

Compound Bevel

Required	T
OD	Lt
ID	B1
B2	Tr

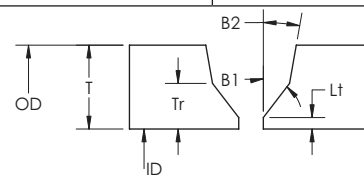

J-Prep

Required	T
OD	Lt
ID	B1
L	R

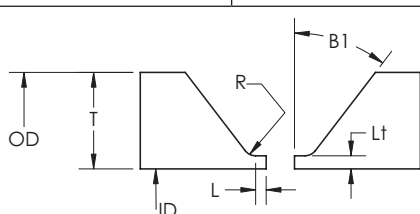

Compound J-Prep

Required	
OD	B1
ID	B2
T	L
L1	Tr
R	

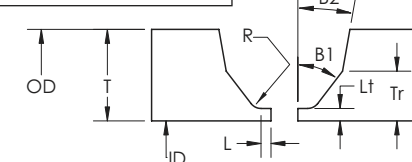

Counterbore

Required	
OD	T
ID	D
CD	A1

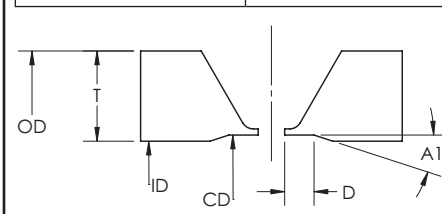



Before



After

Factory Service

Wachs machines are made to work, and built tough to take it. But any machine, even heavy duty ones like ours, may require servicing over time. At E.H. Wachs great service is only a phone call away. Arrange to send us your machine - we'll evaluate it and send you back a no cost recommendation to repair, upgrade, refurbish or replace it. A written quotation is furnished for your approval before any work is begun.

When it comes time for replacement parts or service for your Wachs equipment, trust it to the people who know it best - E.H. Wachs®. If your machine is showing the effects of age or heavy use, consider replacement parts, our factory repair service or a complete refurbishing to like new condition.

Single Source

Nobody is better at supporting their machines after the sale than Wachs, your single source for consumables, OEM replacement parts and factory service. In addition to Genuine Wachs Tooling, our parts department offers a complete inventory of common replacement parts. From simple nuts and bolts to the most complex assemblies, our parts department quickly ships your order to minimize downtime.

Repair, Upgrade, Refurbish

Wachs refurbishing restores your machine to perform and look like new. Wachs factory repaired or refurbished machines are backed with a full replacement parts warranty. Our state of the art major repair and upgrade facility is located in Lincolnshire, IL, with regular parts and service available at our Sales, Service, and Rental Centers located in Illinois, California, Louisiana, New Jersey, South Carolina, Texas, Canada, the UK, Germany, India, and the UAE.

Genuine Parts & Service

- Complete Parts Inventory
- Complete Refurbishing
- Genuine Wachs Tooling
- New Part Warranty
- Factory Repair & Upgrades



Complete Support

E.H. Wachs personnel are available for onsite instruction, safety training and equipment maintenance anywhere around the world. Experienced professionals, they're expert in all aspects of Wachs equipment, from specifying machines and tooling to training your team on their effective use. For advanced training, consider specialized courses at the E.H. Wachs Training Center.

At Your Location or Ours

As the premier manufacturer of portable cutting and weld prep machine tools, E.H. Wachs is best qualified to train your personnel on the proper operation of our products. That's the reason Wachs specialists are available, at your location or ours, for training and instruction on operating and maintaining our precision machine tools.

E.H. Wachs Training Center

For the ultimate in training, the E.H. Wachs Training Center, located at our facility in Lincolnshire, Illinois, offers comprehensive courses for all our products. It's the premier hands-on learning experience for pipe cutting and weld preparation technologies, and is ideal for field machinists in the oil and gas, power generation, petrochemical and related industries.

Your E.H. Wachs instructors are not just academics – all of them have real world experience and participate in the design, development and evolution of these advanced machines. This gives our people unique insight into the latest industry trends, procedures and techniques.

Hands-On Training

At our facility the focus is on classroom education and hands-on training in the operation of portable machine tools. Structured to enhance safe operation, we'll review the setup and operation of Wachs advanced remote control options for all drive motor types. You'll leave with a comprehensive understanding of the industry, plus detailed knowledge and skill in the use and maintenance of these state of the art machines.





Available Worldwide

When it makes more sense to rent than to buy, virtually the entire product lineup of Wachs and Orbitalum are available for rental on a daily, weekly or monthly basis. We maintain a large inventory of machines, welding systems and accessories ready to ship from our Sales, Service, and Rental Centers to virtually any spot on the globe, including remote or offshore locations.

Factory Rentals

Factory rentals are great for short term usage such as emergency repair projects, scheduled turnarounds or power generation outages. Individually inspected and tested before shipment, our machines and welding systems arrive configured for your exact application. Many clients start with renting our products and find them so powerfully productive they choose to purchase.

Offering more than just equipment and tooling, ITW-OCW Sales, Service & Rental Centers are staffed with expert technical product specialists to help you quickly specify the right machine, power source and tooling for your application. Renting with us gives you access to the entire range of technical support and engineering expertise that we're renowned for.

Unrivalled Support

Our rental equipment is available in many locals on a next day basis through our 24 hour on call service. Call today and we'll ship today. Wachs Split Frames, Trav-L-Cutters, Guillotine Saws, EP 424 end prep machines, Orbitalum GF series tube saws, OM180 series orbital welding systems with weld heads are all in stock ready for immediate shipment. In fact virtually every product we manufacture is available as a factory rental.

We're available 24/7 to help with questions, problems or any additional equipment or supplies needed to complete your project. Other options for managing your equipment rentals are available, up to and including specially trained factory onsite technicians to help manage and maintain our machines, or instruct your workforce on their proper use.

ONSITE Rentals



WachsBox for Larger Projects

You may know that E.H. Wachs sells superior weld prep machine tools. You may also know that E.H. Wachs rents our equipment through our worldwide Sales, Service and Rental Centers. And that our rental fleet includes the Orbitalum line of orbital cutting and welding equipment. But what you may not know is Wachs offers a wide range of rental solutions, from daily, weekly or monthly rentals, to our innovative new WachsBox™ program.

Rentals are a great option for short term projects, where machines are used for a unique or one time job. But Rentals can also be a smart option for larger, major projects, where you need pipe cutting, beveling and flange facing machines day in and day out, often 24/7. For this scenario we invented the WachsBox.

The WachsBox is a pre-stocked Conex delivered to the jobsite, preconfigured to your project needs, that remains onsite during your active field machining. The advantage of the WachsBox is that all the tools and tooling needed for onsite machining of pipe and vessels during a turnaround or MRO project are on the ground, ready for use at any time of the day or night.

Ask your local representative for more details about the modern way to rent E.H. Wachs weld prep machine tools and Orbitalum orbital cutting and welding systems, when and where you need them.



Our ITW Partners

When you partner with us you're not only partnering with the industry leader in portable weld preparation machine tools and orbital welding systems, you're partnering with ITW, the industry leader in advanced welding technologies.

ITW has a market leading portfolio of best in class brands including Miller and Hobart, offering reliable and responsible products for the markets we serve.

When reliability matters...
We're there.



 Corporate Locations

★ Sales Locations

Contact your local ITW Orbital Cutting & Welding representative for additional information or to request a product demonstration.

UNITED STATES

ITW-OCW US Headquarters E.H. Wachs®

600 Knightsbridge Parkway
Lincolnshire, IL 60069 USA
T: +1.847.537.8800
F: +1.847.520.1147
Toll Free: 800.323.8185

Northeast Sales, Service & Rental Center E.H. Wachs

1001 Lower Landing Road, Suite 208
Blackwood, New Jersey 08012 USA
T: +1.856.579.8747
F: +1.856.579.8748

Southeast Sales, Service & Rental Center E.H. Wachs

171 Johns Road, Unit A
Greer, South Carolina 29650 USA
T: +1.864.655.4771
F: +1.864.655.4772

West Coast Sales, Service & Rental Center E.H. Wachs

5130 Fulton Drive, Unit J
Fairfield, California 94534 USA
T: +1.707.439.3763
F: +1.707.439.3766

Gulf Coast Sales, Service & Rental Center E.H. Wachs

2220 South Phillippe Avenue
Gonzales, LA 70737 USA
T: +1.225.644.7780
F: +1.225.644.7785

Houston (Pasadena) Sales, Service & Rental Center E.H. Wachs

3327 Daisy Street
Pasadena, Texas 77505 USA
T: +1.713.983.0784
F: +1.713.983.0703

GERMANY

ITW-OCW Europe Headquarters Orbitalum Tools GmbH® E.H. Wachs Sales & Service Center

Josef-Schüttler-Straße 17
Singen D78224 Germany
T: +49 (0) 77 31 - 792 0
F: +49 (0) 77 31 - 792 500

CANADA

Wachs Canada Ltd® Eastern Canada Sales, Service & Rental Center

1250 Journey's End Circle, Unit 5
Newmarket, Ontario L3Y 0B9
Canada
T: +1.905.830.8888
F: +1.905.830.6050
Toll Free: 888.785.2000

Wachs Canada Ltd® Western Canada Sales, Service & Rental Center

5411 82 Ave NW
Edmonton, Alberta T6B 2J6
Canada
T: +1.780.469.6402
F: +1.780.463.0654
Toll Free: 800.661.4235

UNITED KINGDOM

Wachs UK® UK Sales, Service & Rental Centre

Units 4 & 5 Navigation Park
Road One, Winsford Industrial Estate
Winsford, Cheshire CW7 3RL
United Kingdom
T: +44 (0) 1606 861 423
F: +44 (0) 1606 556 364

UNITED ARAB EMIRATES

Wachs Middle East & Africa Operations® E.H. Wachs

PO Box 262543
Jebel Ali Free Zone South
Dubai FZS 5, ACO6
United Arab Emirates
T: +971 4 88 65 211
F: +971 4 88 65 212

INDIA

ITW India Private Limited

Indialand Global Industrial Park
Sr. No.234/235/245, Plot 8, Gala No. 7
Hinjawadi-Phase-1
Tal-Mulshi, Pune 411057 India
T: +91 40 30261812
F: +91 40 30480815

CHINA

ITW Welding China E.H. Wachs / Orbitalum Sales

New Caohejing International Business Centre
Room 2801-B, Building B
No 391 Gui Ping Road
Shanghai 200052, China
T: +86 (0) 21 52 30 37-51
F: +86 (0) 21 52 30 37-58

