

Operating instructions

For responsible bodies and persons using the machine

Pipe Cutting and Beveling Machines

GF 4 (AVM/MVM)

GF 6 (AVM/MVM)

RA 8 (AVM/MVM)

RA 12 (AVM/MVM)



To work safely with this machine, please read through the operating instructions in full before initial operation. Retain the operating instructions for future reference.

Machine no.:

TABLE OF CONTENTS

1.	About these instructions5	6.	Initial operation24
1.1	Warning messages.....5	6.1	Checking the parts of delivery24
1.2	Further symbols and displays.....5	6.2	Included with the machine.....24
1.3	Abbreviations5	7.	Storage and transport25
2.	Information and safety instructions for the responsible body6	7.1	Storage.....25
2.1	Requirements for the responsible body.....6	7.1.1	Position of the cutter in the transport case25
2.2	Using the machine6	7.2	Transport25
2.2.1	Proper use6	7.2.1	Transporting the GF 4, GF 6, RA 8 (AVM/MVM)26
2.2.2	Improper use6	7.2.2	Transporting the RA 1226
2.2.3	Machine constraints.....7	8.	Setup and assembly.....27
2.2.4	Shutting down the machine.....7	8.1	Mounting the pipe cutter on the work bench27
2.3	Environmental protection/disposal.....7	8.1.1	Mounting the quick-mounting plate on the workbench.....27
2.3.1	Chips and gear lubricant oil7	8.1.2	Mounting the pipe cutter on the quick-mounting plate27
2.3.2	Electric tools and accessories7	8.1.3	Pipe feeder (base and extension unit, mobile workstation)28
2.3.3	Returning accumulators and batteries.....8	8.2	Mounting the line laser (only at GF 6 (AVM/MVM))29
2.4	Basic safety instructions8	8.3	Replacing the batteries of the line laser29
2.5	Warning symbols11	8.4	GF 4 and GF 6: fitting the clamping jaws....29
3.	Product design.....12	8.4.1	Fitting the clamping jaws.....30
3.1	Pipe Cutting and Beveling Machine GF 4 ...12	8.5	Fitting the saw blade, bevel cutter, additional cutters.....30
3.2	Pipe Cutting and Beveling Machine GF 6 ...13	8.5.1	Inserting the saw blade or bevel cutter31
3.3	Pipe Cutting and Beveling Machines RA 8, RA 12.....14	8.5.2	Inserting the saw blade/bevel cutter combination.....31
3.4	Automatic Feed Module AVM14	8.6	Adjusting the pipe dimension32
3.4.1	Description of the AVM buttons15	8.6.1	Saw blade without additional cutter32
3.5	Manual Feed Module MVM15	8.6.2	Saw blade with additional cutter33
3.6	Accessories16	8.6.3	Adjusting the bevel cutter34
3.6.1	Saw blades and bevel cutters16	8.7	Selecting the motor speed.....35
3.6.2	Aluminum clamping shells for RA 8, RA 12.....16	8.7.1	Standard values for spindle speed and feed force level (AVM)35
3.6.3	Set of stainless steel caps16	9.	Operation36
3.6.4	Quick-mounting plate with screw clamps.....17	9.1	Processing the pipe with AVM.....37
3.6.5	Special gear oil17	9.1.1	Shutting down (even in an emergency).....37
3.6.6	Saw blade lubricant GF TOP17	9.1.2	Initial operation38
3.6.7	Saw blade lubricant GF LUB17	9.1.3	Cutting the pipe with AVM38
3.6.8	Warning symbols17	9.1.4	Beveling the pipe with AVM39
4.	Features and scope of application.....18	9.1.5	Cutting and beveling pipes simultaneously39
4.1	Features18		
4.2	Additional properties of the GF 4 and GF 6 (AVM/MVM)19		
4.3	Scope of application21		
4.3.1	Working range21		
4.3.2	Materials21		
5.	Technical data.....22		
5.1	Pipe Cutting and Beveling Machines22		
5.2	Line laser23		

9.2	Processing the pipe with MVM.....	40
9.2.1	Shutting down (even in an emergency).....	40
9.2.2	Cutting the pipe with MVM	40
9.2.3	Beveling the pipe with MVM	41
9.2.4	Cutting the pipe with MVM and beveling it simultaneously.....	42
9.3	Processing the pipe manually	43
9.3.1	Shutting down (even in an emergency).....	43
9.3.2	Cutting the pipe manually	43
9.3.3	Beveling the pipe manually	44
9.3.4	Cutting the pipe manually and beveling it simultaneously.....	45
10.	Servicing, maintenance, troubleshooting.....	46
10.1	Maintenance	46
10.1.1	Line laser.....	47
10.2	Checking the oil level of the gear and topping up	47
10.3	Cleaning the slide guide	47
10.4	What to do if? – General trouble-shooting	48
10.4.1	What to do in the event of tool breakage	48
10.5	Error messages/trouble-shooting AVM	49
10.6	Servicing/customer service	50
11.	EU declaration of conformity.....	51
11.1	GF 4, GF 6, RA 8, RA 12 (Standard/MVM) ...	51
11.2	GF 4 AVM, GF 6 AVM, RA 8 AVM, RA 12 AVM	52

1. ABOUT THESE INSTRUCTIONS

To allow quick understanding of these instructions and safe handling of the machine, all the warning messages, notes and symbols used in these instructions are presented here along with their meaning.

1.1 Warning messages

In these instructions, warning messages are used to warn you against the dangers of injury or material damage. Always read and observe these warning messages!



This is a warning symbol. It should warn you against dangers of injury. Follow all instructions which are identified with this safety symbol in order to avoid injuries or death.

Warning symbol	Meaning
 DANGER	Direct danger! Non-observance could result in death or critical injury. ⊙ Restrictions (if applicable). ► Measures to prevent danger.
 WARNING	Possible danger! Non-observance could result in serious injury. ⊙ Restrictions (if applicable). ► Measures to prevent danger.
 ATTENTION	Dangerous situation! ► Non-observance could result in minor injuries.
ATTENTION	Dangerous situation! ► Non-observance could result in material damage.

1.2 Further symbols and displays

Symbol	Meaning
IMPORTANT NOTE	Notes: Contain particularly important information for comprehension.
	Instruction: You must take notice of this symbol.
1.	Request for action in a sequence of actions: You have to do something here.
►	Single request for action: You have to do something here.
▷	Conditional request for action: You have to do something here if the specified condition is met.

1.3 Abbreviations

Abbr.	Meaning
GF, RA	Pipe cutting and beveling machines
AVM	Automatic Feed Module
MVM	Manual Feed Module

2. INFORMATION AND SAFETY INSTRUCTIONS FOR THE RESPONSIBLE BODY

2.1 Requirements for the responsible body

Workshop/outdoor/field application: The responsible body is responsible for safety in the danger zone around the machine, and should allow only qualified personnel to enter the zone or operate the machine in the danger zone.

Employee safety: The safety regulations described in chap. 2 must be observed and work must be carried out with safety in mind using the prescribed protective equipment.

2.2 Using the machine

2.2.1 Proper use

- The machine should be exclusively used for the cutting and beveling of materials and tube dimensions as specified in chap. 4.3, p. 21.
- The machines must only be operated using the voltage levels specified on the drive identification plate and in the "technical data" (see chap. 5, p. 22).
- Only use the motor GF07 (Code 790 142 460 and 790 142 463) as the drive for GF 4. Motor GF09 (Code 790 046 460 and 790 046 463) for RA 8 and RA 12.
- The drive motor may only be used in connection with the machine.
- The Automatic and Manual Feed Module AVM/MVM may only be operated in combination with the Orbitalum Tools pipe cutter GF 4, GF 6, RA 8 or RA 12.
- For GF 4 AVM, GF 6 AVM, RA 8 AVM or RA 12 AVM: only the mains cable of the pipe cutter may be connected to the socket of the AVM.
- The machine may only be used on pipes and containers that are empty, unpressurized, do not have explosive atmospheres and are not contaminated.



Proper use also includes the following:

- observing all safety instructions and warning messages included in these operating instructions
- carrying out all inspection and maintenance work
- sole use in the original condition with original accessories, spare parts and materials
- processing only materials set out in the operating instructions

2.2.2 Improper use

- A use other than that defined under "proper use" or a use that goes beyond this or the specified constraints shall be considered improper use due to the potential risks involved.
- The responsible body shall be solely responsible for damages that arise through improper use and the manufacturer shall assume no liability whatsoever.
- No tools should be used that have not been authorized by the manufacturer for this machine.
- The removal of safety equipment is not permitted.
- Do not misuse the machine.
- The machine is not intended for use by private consumers.
- The technical values defined for normal operation must not be exceeded.
- Do not use the machine as a drive for applications other than those listed under proper use (chap. 2.2.1).

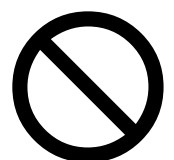

2.2.3 Machine constraints

- Keep your working area clean. Disorder or unlit working areas can lead to accidents.
- The workplace can be in pipe preparation, in plant construction or in the plant itself.
- A radial space requirement/freedom of movement of approx. 2 m around the machine is required for people.
- Work lighting: min. 300 lux.
- Operator age: at least 14 years old and without physical impairments.
- Operated by one person.
- Climate conditions: temperature range for machine operation: –15 °C to 40 °C (< 80% rel. humidity).
- Only work with the machine in dry surroundings (not in misty, rainy or stormy conditions).

2.2.4 Shutting down the machine

Information on the EMERGENCY STOP or the shutting down function:

For processing with AVM, see chap. 9.1.1, p. 37.

For processing with MVM, see chap. 9.2.1, p. 40.

For manual processing, see chap. 9.3.1, p. 43.

2.3 Environmental protection/disposal

2.3.1 Chips and gear lubricant oil

Dispose of chips and used gear lubricant oil according to the regulations.

2.3.2 Electric tools and accessories

Discarded electric tools and accessories contain large quantities of valuable raw and synthetic materials that can be recycled. Therefore:

- Electrical (electronic) devices that are marked with the symbol at the side may not be disposed of with household waste in accordance with EU regulations.
- By actively using the available return and collection systems, you actively contribute to the reuse, recycling and utilization of electrical (electronic) devices.
- Used electrical (electronic) devices contain parts that must be handled selectively according to EU regulations. Separate collection and selective treatment is the basis for environment-friendly disposal and the protection of human health.
- Appliances and products that you bought from us after August 13, 2005 will be disposed of in accordance with legal standards after they have been supplied to us at no cost.
- We may refuse to accept old appliances that pose a risk to human health or safety due to contamination produced during use.
- The end user is responsible for disposing of used appliances introduced to the market before August 13, 2005. Please contact a disposal center near you for this purpose.
- **Important for Germany:** our products may not be disposed of in municipal disposal sites as they are only used for industrial purposes.

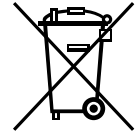

(as per RL 2002/96/EC)

2.3.3 Returning accumulators and batteries

- Accumulators and batteries that are marked with the adjacent symbol may not be disposed of with household garbage as per EU Directive 91/157/EEC.
- In the case of accumulators and batteries containing hazardous materials the chemical sign for the heavy metal contained is specified below the refuse bin:
- Cd = Cadmium Hg = Mercury Pb = Lead
- **Valid for Germany:** The end consumer is obliged to return defective or used accumulators and batteries to the distributor or to the returning facilities set up to this purpose.

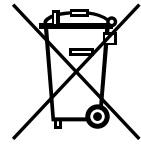









2.4 Basic safety instructions

The pipe cutting and beveling machine (hereinafter referred to as the GF 4, GF 6, RA 8 or RA 12 (AVM/MVM)) is a state-of-the-art machine designed for safe use. The risks involved in using the machine are described in the operating instructions below. Using this machine in a way other than that described in these instructions can lead to serious physical injury and material damage.

Therefore:

- Observe warning messages at all times.
- Keep complete documentation close by the machine.
- Generally valid regulations for the prevention of accidents must be observed.
- Observe country-specific regulations, standards and guidelines.
- Always ensure that the machine is in good working order. Observe the maintenance information (see chap. 10.1, p. 46).
- Only operate the machine if all the safety equipment such as the restart inhibitor, overload protection and chips guard are in good working order and the machine is firmly positioned. Check whether the substrate is able to take sufficient loads.
- Report any unusual machine behavior to the person responsible immediately.
- Only use the dimensions and materials specified in these instructions. Other materials should be used only after consulting with Orbitalum Tools customer service.
- Use only original tools, spare parts, materials and accessories from Orbitalum Tools.
- Repair and maintenance work on the electrical equipment may only be carried out by a qualified electrician.
- At the end of each working cycle, before transportation, changing tools, cleaning and performing any maintenance, adjustment or repair work, switch off the machine, allow it to run to a stop and pull the mains plug.
- Do not carry the machine by the cable and do not use the machine to pull out the plug except in an emergency. Protect the cable from heat, oil and sharp edges (chips).
- During operation, keep hands away from the tools.
- Check that the work piece is correctly clamped.
- Switch on the machine only when the pipe has been clamped.
- When working with the AVM: in case of danger, immediately press the EMERGENCY OFF button.
- When working with the AVM, the AVM stops automatically after each cut. If you are working manually, switch off the machine after each working cycle (ON/OFF switch of the pipe cutter) and allow the machine to run to a stop.
- When working with the AVM, do not stand in the swiveling range while the automatic rotary housing is rotating).
- When working with the AVM: the machine may only be operated with the AVM protective bar assembled (for information on the protective bar, see chap. 3.4, p. 14).
- Do not use the machine in wet surroundings. Only work in canopied surroundings.
- In extreme conditions of use, conductive dust can settle inside the machine. For this reason and for better safety, an on-site SPE-PRCD or ground-fault circuit is required between the mains network and the machine, to be installed and tested if necessary by a professional electrician.
- When working with the machine wear safety shoes (as per EN ISO 20345 at least S1), safety goggles (as per DIN EN 166 Class 2, basic strength S), snug-fitting safety gloves (as per DIN EN 388, Class 2 resistance to abrasion, cut resistance Class 3, tear resistance Class 2, perforation resistance Class 3 and as per EN 407 at least Performance level 1 against contact heat) and hearing protection (as per DIN EN 352-4 or comparable).
- Do not use click-in socket outlets and click-in power plugs (blue CEE power plugs) for power connection, otherwise the EMERGENCY STOP does not function. The user must check whether the power plug can be pulled out of the outlet by the cable (shutdown, see chap. 9.3.1, p. 43).

- Do not use angled power plugs.

NOTE	The recommendations concerning "Personal protective equipment" only apply to the product being described. Other requirements resulting from the ambient conditions on-site or of other products, or from combining with other products, are not taken into account. These recommendations do not in any way release the responsible body (employer) from its statutory health and safety at work obligations towards its employees.	
 DANGER	<p>If the mains cable is damaged, live parts may cause death if touched directly! Fatal electric shock.</p> <ul style="list-style-type: none"> ⊘ Keep the mains cable of the cutter motor away from the saw blade or bevel cutter. ⊘ Do not let the cut-off pipe piece drop in an uncontrolled manner. ⊘ Do not run the machine unattended. ▶ Secure the falling pipe piece. ▶ During processing, always keep an eye on the position of the mains cable. ▶ Keep the machine clean. Always remove lubricant residues from the machine. ▶ The electrical supply cable on the AVM may only be replaced by a qualified electrician. 	
 DANGER	<p>Damaged insulation! Fatal electric shock.</p> <ul style="list-style-type: none"> ⊘ Do not screw any indicators or signs to the drive motor. ▶ Use stickers. 	
 DANGER	<p>Damaged plug! Fatal electric shock.</p> <ul style="list-style-type: none"> ⊘ Do not use adapter plugs with ground protected electrical tools. ▶ The machine connector plug must fit the socket. 	
 DANGER	<p>Risk of danger through the use of the machine outdoors! Fatal electric shock.</p> <ul style="list-style-type: none"> ⊘ Do not use the machine outdoors. 	
 DANGER	<p>Danger! The electrical motor can overheat with operation of less than 230 V network! Serious injury or death.</p> <ul style="list-style-type: none"> ▶ Only use the machine in the specified temperature range. 	
 DANGER	<p>Grounded body! Fatal electric shock.</p> <ul style="list-style-type: none"> ▶ Avoid contact with grounded surfaces such as tubes, heating, cookers or refrigerators. 	
 DANGER	<p>Loose/baggy clothing, long hair or jewelry can get caught in rotating machine parts! Serious injury or death.</p> <ul style="list-style-type: none"> ▶ Wear tight-fitting clothing when using the machine. ▶ Tie up long hair to prevent it from being caught. 	
 DANGER	<p>Safety components that are contaminated, worn or broken are defective! The failure of safety components can cause physical injury.</p> <ul style="list-style-type: none"> ⊘ Do not misuse the cable, e.g. such as using it to suspend or carry the machine. ▶ Replace defective safety components immediately and check them daily to ensure proper operation. ▶ Replace defective mains cable immediately by a specialist. ▶ Clean and perform maintenance on the machine after each use. ▶ Keep cables away from heat, oil, sharp edges and moving equipment parts. ▶ Inspect the machine daily for visible signs of damage or defects, and have them repaired by a specialist if necessary. 	



WARNING

Flying parts/breaking tool!

Diverse physical injuries and material damage.

- ⊘ **Do not** process the pipe while it is loose in the vice.
- ⊘ **Never** use a damaged or deformed saw blade or bevel cutter.
- ⊘ In the event of tool breakage with a new tool, do **not** enter the old cut because the tool can break again (for details of what to do in the event of tool breakage, see chap. 10.4.1, p. 48).
- ▶ Clamp the pipe to be cut into the vice.
- ▶ Immediately replace worn-out tools.
- ▶ Ensure that the cutting tools are correctly fitted.
- ▶ Pipe dimension must be set correctly. During cutting, the saw blade must saw through the entire pipe wall.
- ▶ Avoid breaking tool through low (adequate) feed force, correct dimension (see chap. 8.6, p. 32) and speed (see chap. 8.7, p. 35) settings.
- ▶ Hold on to the motor unit tightly by the handle, and guide it with low (adequate) feed force during the machining process.



WARNING

Falling objects or tilting and bending pipes!

Irreversible crushing.

- ▶ Wear safety shoes (in accordance with EN ISO 20345, at least S1).
- ▶ Place sufficient supports under the tube.
- ▶ Transport the machine as shown in chap. 7.2, p. 25.



WARNING

Danger caused by vibration and unergonomic, monotonous work!

Discomfort, tiredness and disruptions to the locomotor system.

Limited ability to react, and cramps.

- ▶ Do relaxation exercises.
- ▶ Ensure activity is varied.
- ▶ Assume an upright, fatigue-free and comfortable body position during operation.



WARNING

Pressing the ON-OFF switch unintentionally!

Diverse physical injuries and material damage.

- ▶ At the end of each working cycle, before transportation, changing tools, cleaning and performing any maintenance, adjustment or repair work, switch off the machine, allow it to run to a stop and pull the mains plug.



WARNING

Dangerous laser radiation!

The eye retina or eye vision can be impaired.

- ⊘ **Do not** look at the laser beam or view it using optical instruments.
- ⊘ **Do not** point the laser beam at other people.
- ⊘ **Do not** misuse the line laser and do not remove from the pipe cutter.
- ▶ Ensure that the line laser is switched off during mounting/dismantling.

CAUTION!

Use of controls or adjustments or performance of procedures other than those specified herein may result in hazardous radiation exposure.

2.5 Warning symbols

Observe all of the warnings and safety instructions affixed to the machines.
The following labels also appear on the machine:

Image	Type of machine	Position on machine	Meaning	Code
	GF 4 (AVM/MVM), GF 6 (AVM/MVM), RA 8 (AVM/MVM), RA 12 (AVM/MVM)	Motor, side	INSTRUCTION: Wear safety goggles in accordance with DIN EN 166, ear protection in accordance with DIN EN 352 and tight-fitting safety gloves in accordance with DIN EN 388 and EN 407. Read the operating instructions.	790 086 200
	GF 4 (AVM/MVM), GF 6 (AVM/MVM), RA 8 (AVM/MVM), RA 12 (AVM/MVM)	Chips guard, front	WARNING: Danger of being injured by sharp cutting edges.	790 046 196
	GF 4 (AVM/MVM)	Directly on laser	WARNING: Laser class I.	<u>For Laser 790 142 125:</u> 790 142 288 <u>For Laser 790 142 135:</u> 790 142 298*
	GF 4 (AVM/MVM)	Holder indicut (laser)	WARNING: Dangerous laser radiation.	790 142 289
	GF 6 (AVM/MVM)	Directly on laser	WARNING: Laser class I.	790 142 288
	GF 6 (AVM/MVM)	Slide housing	WARNING: Dangerous laser radiation.	790 142 289

* Warning symbol with Code 790 142 298:



3. PRODUCT DESIGN

NOTE The chips guard is a safety component. The functionality of the chips guard must be checked daily. The chips guard must be able to bend back into the original position (see figures) independently on all of the machines below.

3.1 Pipe Cutting and Beveling Machine GF 4

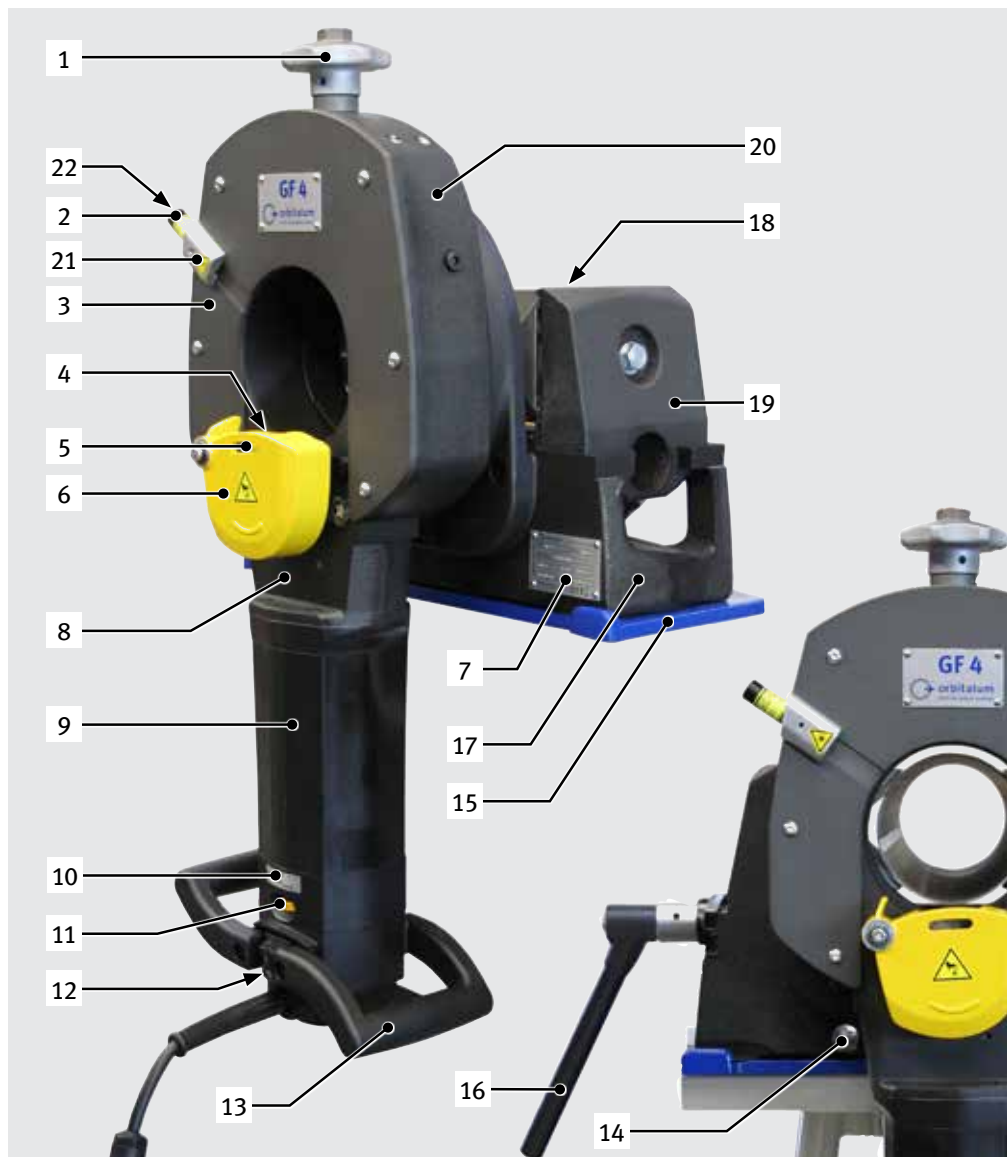

1. Star handle
2. Laser beam pointer
3. Cover plate
4. Saw blade/bevel cutter
5. Opening for meter rule
6. Chips guard
7. Identification plate/
machine number
8. Slide block
9. Motor
10. Rotating-speed
indicator
11. RPM regulator
12. ON-OFF switch
13. Handle
14. Retainer for vice
handle/Holding fixture
for length gauge
15. Mounting plate
16. Multifunctional wrench/
vice handle
17. Vice body
18. Circular clamping jaws
19. Slide jaw
20. Slide housing
21. Holder indicut (laser)
22. ON-OFF switch line
laser

3.2 Pipe Cutting and Beveling Machine GF 6



1. Star handle
2. Cover plate
3. Circular clamping jaws
4. Saw blade/bevel cutter
5. Chips guard
6. Identification plate/
machine number
7. Slide block
8. Motor
9. Rotating-speed
indicator
10. RPM regulator
11. ON-OFF switch
12. Handle
13. Mounting plate
14. Retainer for vice
handle/Holding fixture
for length gauge
15. Multifunctional wrench/
vice handle
16. Vice body
17. Laser beam pointer
18. Slide jaw
19. Slide housing
20. ON-OFF switch line
laser

3.3 Pipe Cutting and Beveling Machines RA 8, RA 12

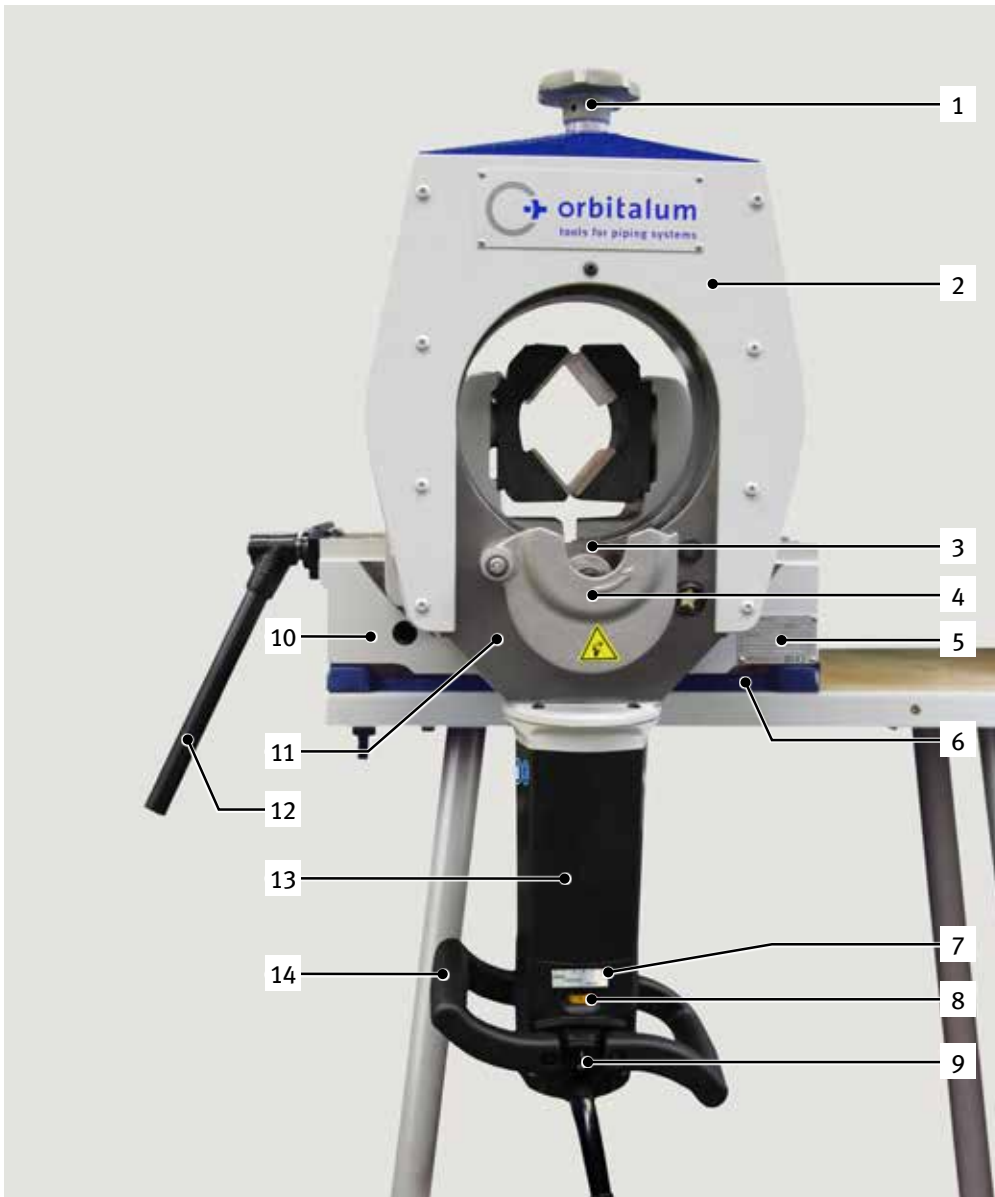

1. Star handle
2. Cover plate
3. Saw blade/bevel cutter
4. Chips guard
5. Identification plate/
machine number
6. Mounting plate
7. Rotating-speed
indicator
8. RPM regulator
9. ON-OFF switch
10. Vice body
11. Slide block
12. Multifunctional wrench/
vice handle
13. Motor
14. Handle

3.4 Automatic Feed Module AVM

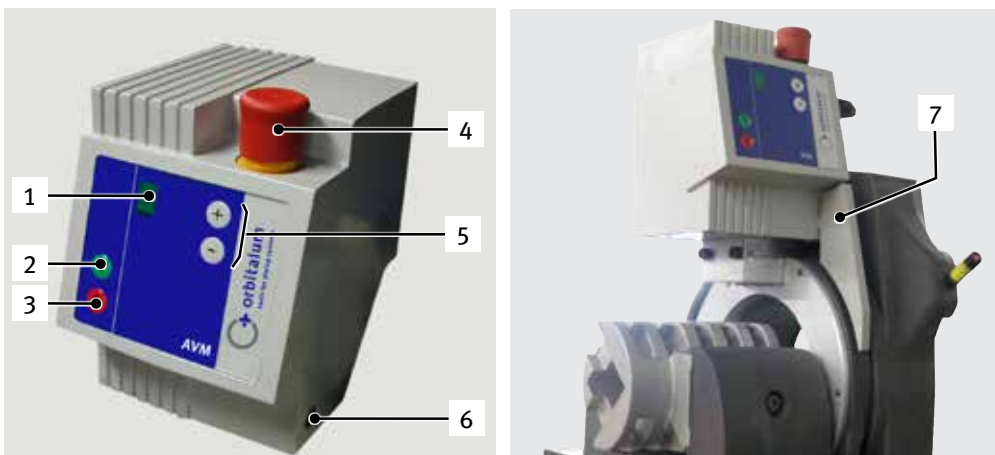

1. Display
2. Start button
3. Stop button
4. EMERGENCY STOP
button
5. Buttons for the feed
force level
6. Light barrier
7. Protective bar

3.4.1 Description of the AVM buttons

Display: If the control unit is connected to the power supply, the display shows the feed force level currently selected. A point is shown in the bottom right of the display to signal that the light barrier recognizes the reflector. The AVM can only be started with reflector recognition. If a fault occurs, this indicator blinks every second and displays **F** and a number from **1** to **6**. For error messages/trouble-shooting, see chap. 10.5, p. 49.

Feed buttons: By pressing these buttons, it is possible to preset the desired feed force in 9 levels. If the device is ready for operation, these buttons may be pressed at any time to set the feed force level or to vary it during processing. If one of the buttons remains pressed by the user, the display runs in the direction selected by the user.

START button: The machining process is initiated by pressing this button when the cutter motor is running. After start-up, this button serves no further function. It also has no function during a fault or while the software version is being displayed.

STOP button: Pressing this button during the machining process stops the feed and the cutter motor. The cutter motor then has to be returned to the starting position. By pressing the zero button the cutter motor can be turned back more easily. The cutter motor must not be running. As soon as a point lights up in the bottom right of the display the AVM can be restarted.

Calling up the current version of the AVM: The version is displayed when the **+**/**-** buttons are pressed simultaneously. The following sequence then flashes: **S 2 0 0 H 1 2 3**. The first letter, S stands for software, the next three letters stand for the software version, then there is an H for hardware and the three numbers that indicate the hardware version. Then the display returns to the last feed force level that was set.

EMERGENCY STOP button

Only press in an emergency. Pressing the EMERGENCY STOP button interrupts the power supply. Unlock the button to restart.

With error messages the 0 button can be used to switch off the AVM, the error then no longer appears in the display.

3.5 Manual Feed Module MVM

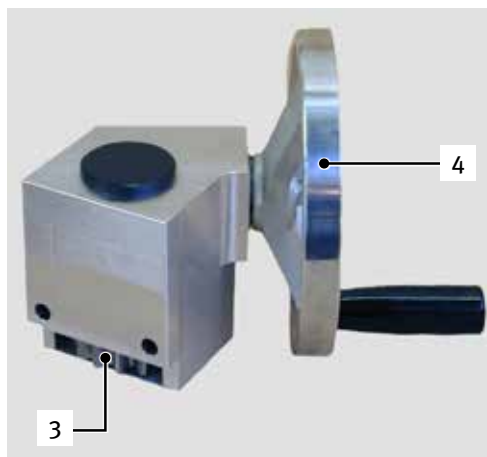
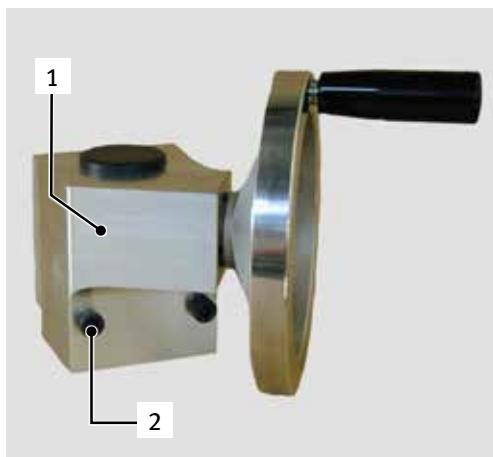

1. Gear
2. Fastening screws
3. Gear drive with free-wheel
4. Hand wheel

3.6 Accessories

Not included as standard.



WARNING

Danger presented by using poor-quality accessories and tools not approved by Orbitalum Tools!
Diverse physical injuries and material damage.

► Use only original tools, spare parts, materials, and accessories from Orbitalum Tools.

3.6.1 Saw blades and bevel cutters

All saw blades and bevel cutters are specially developed for Orbitalum Tools pipe cutters to endure maximum strain and have a maximum tool life.

4 different saw blades and bevel cutters are available for different uses:



Workable pipe materials	Al	Mild steel, Cu, CuNi, CuZn, CuSn	INOX, V2A, V4A, 304, 316 (L)	Ti, Duplex, Inconel
Economy range for low and non-alloy steels and cast iron pipes	*	*		
Performance range for high-alloy steels (stainless steel)		*	*	
High-Performance range for high-performance materials and high-alloy steels		*	*	*
Premium range especially made for stainless steel applications with extra long durability			*	

Please see our latest product catalog for a large selection of saw blades and bevel cutters.

3.6.2 Aluminum clamping shells for RA 8, RA 12

For deformation-free clamping of thin-walled pipes. The aluminum clamping shells are produced for specific customers. When ordering, please indicate the outside diameter and/or inside diameter and the wall thickness of the pipe to be processed.

4 cylinder screws and 1 set of clamping shells are included.

When ordering clamping shells for RA 8, you also receive 1 drilling jig for assembling clamping shells and 2 cylinder screws for the drilling jig. Other dimensions are available.

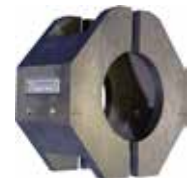

Please see our latest product catalog for a large selection of aluminum clamping shells.

3.6.3 Set of stainless steel caps

For GF 4 and GF 6 (AVM/MVM). Prevents contact corrosion between tube and clamping parts. The stainless steel caps are supplied as standard with the GF 4 and GF 6 (AVM/MVM).



Article	Version	Code
Set of stainless steel caps for GF 4	right + left	790 142 241
Set of stainless steel caps for GF 6	right + left	790 143 200

3.6.4 Quick-mounting plate with screw clamps

For quick mounting of the machine on work benches.
Ideal for frequent changes of location.



Article	Code
Quick-mounting base plate for GF 4, GF 6, GFX 6.6, RA 4, RA 6, RA 8, RA 41 Plus	790 042 027

3.6.5 Special gear oil

For all GF and RA machines.



Article	Version	Code
Special gear oil	Bottle, 250 ml	790 041 030

3.6.6 Saw blade lubricant GF TOP

Synthetic high-performance lubricant for cutting and beveling machines. Increases the tool life of the saw blade. Compliant with the NSF H2 food approval. The screwable brush guarantees an easy and uniform application of lubricant on the saw blade.



Article	Version	Code
Saw blade lubricant GF TOP	Tube, 180 g	790 060 228

3.6.7 Saw blade lubricant GF LUB

Chlorine-free high-performance lubricant for cutting and beveling. Increases the tool life of the saw blade. This ecologically cutting compound is the environmentally friendly replacement for ROCOL: just with a new name and improved quality. GF LUB meets the latest environmental directives and ecological standards.



Article	Version	Code
Saw blade lubricant GF LUB	Tube, 160 ml	790 041 016

3.6.8 Warning symbols

Overview of warning symbols with order numbers, see chap. 2.5, p. 11.

4. FEATURES AND SCOPE OF APPLICATION

4.1 Features

The pipe cutters are distinguished by the following characteristics:

- Enhanced safety due to stationary pipe – rotating tool.
- A restart inhibit function prevents the machine from starting in an uncontrolled way after it has been re-connected to the electric mains or after the voltage supply has been re-established following a power failure.
- Self-centering clamping system.
- Low-maintenance gear with oil lubrication.
- Saw motor with RPM control and ergonomically optimized motor for more secure operator position.
- Burr-free cutting surface and deformation-free pipe cross-section.
- Cold machining process.
- Quick cutting process.
- Production of standardized welding bevels.
- Cutting of pipe elbows.
- Quick tool change.
- Plug connection with quick-disconnect coupler: for easy and comfortable replacement of the power cable. Also prevents cables from twisting.
- Working without getting tired when cutting and beveling pipes with larger pipe dimensions and thicker walls.
- Laser beam for optically marking the cutting area (for GF 4 and GF 6 AVM/MVM only).
- Locking mechanism of the slide housing prevents unauthorized usage and theft (for GF 4 and GF AVM/MVM only).

Additional properties of the GF 4 AVM, GF 6 AVM, RA 8 AVM or RA 12 AVM:

- The intelligent control system of the AVM monitors the feed force continuously depending on the torque and the parameter settings.
- The operator position guarantees the best possible protection against hot chips flying around.
- Advancing the pipe cutter in a usual way by operating the handle of the pipe cutter motor is always possible (e.g. when cutting thin-walled pipes).

4.2 Additional properties of the GF 4 and GF 6 (AVM/MVM)

Protection against corrosion



Anthracite-colored coated components for improved sliding properties and protection against corrosion.

Multifunctional wrench

Detachable. It is possible to make 6 different adjustments on the machine using this multifunctional wrench:



Dimension adjustment



Vice handle



Fixture for clamping jaws (GF 4 (AVM/MVM) only)



Fixture for saw blade/bevel cutter



Fixture of the saw for quick-mounting plate

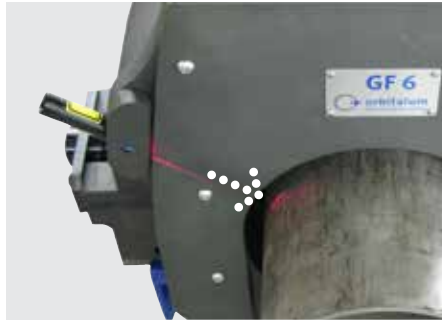

Locking mechanism of the slide housing prevents unauthorized usage and theft

Line laser to display cut-off point

To mark the cut-off point on the pipe. Ideal for checking whether the pipe is adjusted to the desired cut-off point. A red line that marks the cut-off point appears on the clamped pipe once the red button on the line laser has been pressed. If necessary, the pipe position can be corrected until the desired cut-off point is marked.

Reversible clamping jaws

The reversible clamping jaws are a standard feature of the GF 4 and GF 6 (AVM/MVM). Turning the clamping jaws allows the following pipe diameters to be processed:

Machine	Pipe OD [mm]	Pipe OD [inch]
GF 4 (AVM/MVM)	12 - 56 / 20 - 120	0.472 - 2.205 / 0.787 - 4.724
GF 6 (AVM/MVM)	21.3 - 106 / 106 - 168.3	0.839 - 4.173 / 4.173 - 6.626

Clamping jaw assembly, see chap. 8.4, p. 29.

Plug connection with quick-disconnect coupler

For easy and comfortable replacement of power cables.

Optimized chip guard

Optimized chip guard protects against flying chips and comes with a meter rule slot for measuring the pipe length (GF 4 only).

Stainless steel clamping attachment

Ideal for processing stainless steel pipes. For protection against contact corrosion.

4.3 Scope of application

4.3.1 Working range

Type of machine		GF 4 (AVM/MVM)	GF 6 (AVM/MVM)	RA 8 (AVM/MVM)	RA 12 (AVM/MVM)
Pipe OD/pipe elbow OD*	[mm]	12 - 120	21.3 - 168.3	114 - 230	157 - 325
	[inch]	0.472 - 4.724	0.839 - 6.626	4.488 - 9.055	6.181 - 12.795
Wall thickness (depends on material)**	[mm]	1 - 9	1.5 - 15	2 - 10	2 - 10
	[inch]	0.039 - 0.354	0.059 - 0.591	0.079 - 0.394	0.079 - 0.394
Pipe ID min. (Saw blade Ø 63 mm/2.480")	[mm]	21	30	137	190
	[inch]	0.827	1.181	5.394	7.480
Pipe ID min. (Saw blade Ø 68 mm/2.677")	[mm]	16	25	132	185
	[inch]	0.630	0.984	5.197	7.283
Pipe ID min. (Saw blade Ø 80 mm/3.150")	[mm]	4	13	120	173
	[inch]	0.157	0.512	4.724	6.811
Pipe ID min. (Saw blade Ø 100 mm/3.937")	[mm]	–	0	100	153
	[inch]	–	0	3.937	6.024
Pipe ID min. (Saw blade Ø 110 mm/4.331")	[mm]	–	0	–	–
	[inch]	–	0	–	–

* The pipe elbows can only be separated with the GF 4 and GF 6 (AVM/MVM).

** With automatic cutting process. Greater wall thicknesses possible through manual feed or through another cut-off point (depending on the diameter of the saw blade). Special clamping shells (accessory) may be necessary for thin pipe wall thicknesses.

*** max. wall thickness: 7.5 mm (0.296 inch).

4.3.2 Materials

- High-quality steel (any Cr and Mo content)
- High-quality stainless steel (any Cr and Mo content)
- High-quality steel (Cr < 12% and Mo < 2.5%; Cr < 20% and Mo = 0%): case hardened steels, high-speed steels, tempering steels, bearing steels, tool steels
- Black and galvanized steel pipe
- General structural steel
- Annealed cast iron pipe (GGG)
- Aluminum
- Brass
- Copper
- Plastics (PE, PP, PVDE, PVC)

5. TECHNICAL DATA

5.1 Pipe Cutting and Beveling Machines

Type of machine		GF 4 (AVM/MVM)	GF 6 (AVM/MVM)	RA 8 (AVM/MVM)	RA 12 (AVM/MVM)
Dimensions (lxwxh)	[mm]	680 x 325 x 480	920 x 352.7 x 574	778 x 485 x 430	940 x 592 x 374
	[inch]	26.8 x 12.8 x 18.9	36.2 x 13.9 x 22.6	30.6 x 19.1 x 16.9	37.0 x 23.3 x 14.7
Dimensions (lxwxh) with AVM	[mm]	810 x 325 x 480	972 x 352.7 x 574	918 x 485 x 430	1.070 x 592 x 374
	[inch]	31.9 x 12.8 x 18.9	38.3 x 13.9 x 22.6	36.1 x 19.1 x 16.9	42.1 x 23.3 x 14.7
Dimensions (lxwxh) with MVM	[mm]	780 x 325 x 480	920 x 352.7 x 574	788 x 485 x 430	1.090 x 592 x 374
	[inch]	30.7 x 12.8 x 18.9	36.2 x 13.9 x 22.6	31.0 x 19.1 x 16.9	42.9 x 23.3 x 14.7
Machine weight approx.*	[kg]	55.0	92.7	102.5	138.6
	[lbs]	121.2	204.4	225.9	305.6
Machine weight approx.* with AVM	[kg]	64.5	101.7	110.0	146.1
	[lbs]	142.2	224.2	242.5	322.1
Machine weight approx.* with MVM	[kg]	60.0	97.8	104.6	140.7
	[lbs]	132.2	215.6	230.6	310.2
Versions, 1 phase AC	[V,Hz]	230 V, 50/60 Hz	230 V, 50/60 Hz	230 V, 50/60 Hz	230 V, 50/60 Hz
	[V,Hz]	120 V, 50/60 Hz	120 V, 50/60 Hz	120 V, 50/60 Hz	120 V, 50/60 Hz
Power without AVM	[kW]	1.8	1.8	1.8	1.8
	[HP]	2.41	2.41	2.41	2.41
Power with AVM	[kW]	1.9	1.9	1.9	1.9
	[HP]	2.54	2.54	2.54	2.54
Power AVM	[kW]	0.05	0.05	0.05	0.05
	[HP]	0.07	0.07	0.07	0.07
Protection class	Double-insulated according to Class II, DIN EN 60745-1				
Protection class with AVM	Double-insulated according to Class I, EN 60204-1				
Protection class with MVM	Double-insulated according to Class II, DIN EN 60745-1				
Tool speed	[rpm]	40 - 215	40 - 215	40 - 215	40 - 215
Slide housing speed with AVM	[rpm]	0.1 - 3.9	0.3 - 3.5	0.1 - 2.3	0.1 - 1.8
Slide housing torque max. with AVM	[Nm]	101	353	165	210
Sound pressure level at the workplace approx.**	[dB (A)]	79	79	79	79
Vibration level	[m/s ²]	< 2.5 in accordance with DIN EN 28662, Part 1			
Mains fuse by customer	[A]	16	16	16	16

* Weight without packaging and accessories.

** The sound pressure level was measured under normal operating conditions in accordance with EN 23741.

5.2 Line laser

Component for the GF 4 and GF 6 (AVM/MVM) only.

Dimensions (lxb)	[mm]	68 x 15
	[inch]	2.7 x 0.59
Weight	[g]	30
	[lbs]	0.012
Power, Total Emitted	[mW]	5
	[HP]	5x10 ⁻⁶
Power for Classification	[μW]	< 390
Beam range	[m]	1
	[inch]	39.37
Wave length	[nm]	650
Operating voltage	[V DC]	2.8 to 4.5
Operating current	[mA]	20
Operating temperature	[°C]	-10 to 40
Storage temperature	[°C]	-40 to 80
Laser class	Class 1	
Battery type	2 x LR44 / AG13	

6. INITIAL OPERATION

6.1 Checking the parts of delivery

- Check delivery for completeness and damage caused by transport.
- Report any missing parts or damage caused by transport to your supplier immediately.

6.2 Included with the machine

Subject to modifications.

PC	Article	GF 4 (AVM/MVM*)	GF 6 (AVM/MVM*)	RA 8 (AVM/MVM*)	RA 12 (AVM/MVM*)
1	Pipe Cutting and Beveling Machine	x	x	x	x
1	Transport case	x	x	x	x
1	Set of stainless steel caps	x	x	–	–
1	Saw blade, Code 790042 064	...043 018	...043 018	...043 018
1	Mounting plate	x	x	x	x
1	Line laser with fastening screw**	x	x	–	–
1	Tool key set	x	x	x	x
1	Tube of saw blade lubricant GF TOP	x	x	x	x
1	Bottle of special gear oil (Code 790 041 030)	x	x	x	x
1	Set instruction manual and spare parts list	x	x	x	x

* The automatic and manual feed module AVM/MVM is already fitted to the pipe cutter upon delivery.

** The line laser is already mounted at the GF 4 (AVM/MVM) on delivery. At the GF 6 (AVM/MVM) the line laser is supplied separately and has to be mounted on the machine before commissioning (see chap. 8.2, p. 29).

7. STORAGE AND TRANSPORT

7.1 Storage



ATTENTION

Incorrect machine storage!

Diverse physical injuries and material damage.

- ▶ Store the machine in its original crate in a dry environment.

NOTE

For GF 4, GF 6, RA 8 or RA 12 with AVM/MVM: The automatic and manual feed module AVM/MVM is already fitted to the pipe cutter upon delivery.

7.1.1 Position of the cutter in the transport case



GF 4 (AVM/MVM)

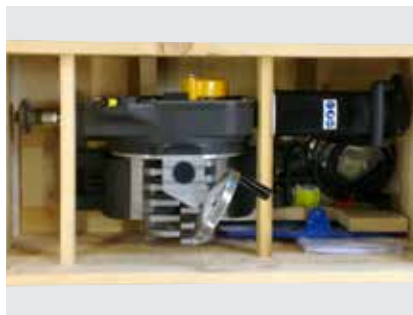

GF 6 (AVM/MVM)



RA 8, RA 12 (AVM/MVM)

NOTE

The accessories in the GF 6 (AVM/MVM) must be taken out of the transportation case before the frame is removed.

7.2 Transport



DANGER

Fatal electric shock!

- ▶ Before transportation or changing the workplace, allow the machine to run to a stop and pull the mains plug.



WARNING

During transportation, the ON/OFF switch may unintentionally be activated causing the machine to start up!

Diverse physical injuries and material damage.

- ▶ Before transportation or changing the workplace, allow the machine to run to a stop and pull the mains plug.



WARNING

Heavy weight when transporting the pipe cutters!

Danger of being injured through overstraining.

- ▶ Transport pipe cutters over long stretches with corresponding lifting aids.

7.2.1 Transporting the GF 4, GF 6, RA 8 (AVM/MVM)

1. Loosen the hexagon bolt (1) on the quick-mounting plate.
2. Guide suitable transport straps through the pipe cutter slide housing.
3. Carefully lift the cutter at the straps and insert in the assembled quick-mounting plate on the side.
4. Bolt the pipe cutter securely in place on the mounting plate with the hexagon bolt (1).



7.2.2 Transporting the RA 12

1. Suspend the crane hooks in the catch (2), lift and insert in the assembled quick-mounting plate on the side.
2. Bolt the pipe cutter securely in place on the mounting plate with the hexagon bolt (1).



8. SETUP AND ASSEMBLY

NOTE The steps described in chap. 8 are the same for all GF and RA versions.

8.1 Mounting the pipe cutter on the workbench

Mount the pipe cutter together with the vice, either:

- on the quick-mounting plate (see chap. 8.1.1 for assembly), or
- on the quick-mounting plate with screw clamps (plate is clamped directly to the workbench without pre-drilling).

8.1.1 Mounting the quick-mounting plate on the workbench

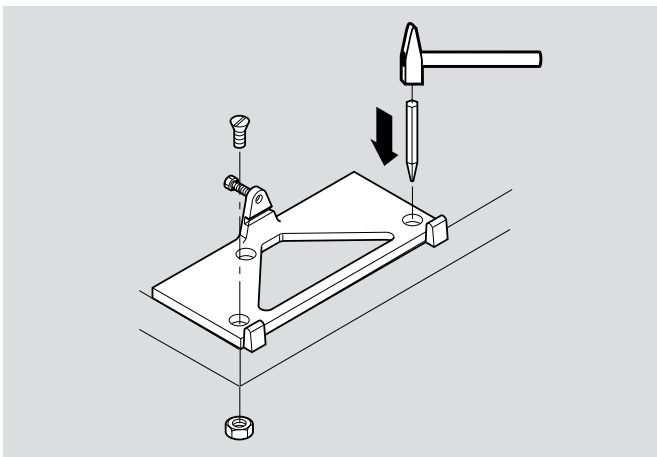

1. Mark and punch the bolt holes on the workbench. Use the quick-mounting plate as a template.
2. Drill \varnothing 13 mm holes.
3. Fasten the quick-mounting plate with screws.

8.1.2 Mounting the pipe cutter on the quick-mounting plate

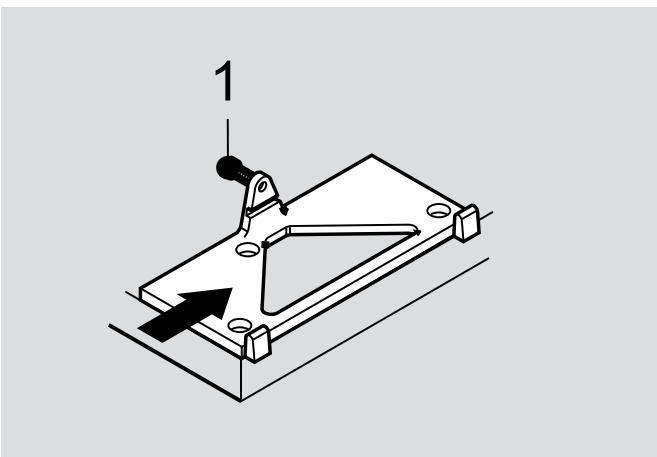

1. Only insert the pipe cutter in the assembled quick-mounting plate on the side with the help of a crane or a similar lifting tool.
2. Bolt the pipe cutter securely in place with the hexagon bolt.

8.1.3 Pipe feeder (base and extension unit, mobile workstation)

When using the Orbitalum Tools pipe feeder base unit, the pipe cutter is directly fitted to the mounting plate of the base unit without special accessories (special accessories, code no. 790 068 051).

NOTE We recommend supporting pipes longer than 1 m with one of the pipe feeders listed below (all special accessories).



Pipe feeder base unit (Code 790 068 051)



Pipe feeder extension unit (Code 790 068 061)



Mobile Workstation (Code 790 068 071)

8.2 Mounting the line laser (only at GF 6 (AVM/MVM))

NOTE In order to protect the line laser against transportation damage it is supplied separately at the GF 6 (AVM/MVM) and has to be mounted on the machine before commissioning. We recommend dismantling the line laser before every transportation of the machine.

1. Take the Indicut line laser (1) out of the packaging and insert it together with the Plexiglas pane into the provided opening (2) of the line laser holder at the machine.
2. Switch on the line laser and align it. The line of the laser has to be at a right angle to the pipe axis.
3. Carefully tighten the threaded pin M6x5 (3) (Code 445 001 210) of the line laser holder using an Allen key (Code 024 387 003).



8.3 Replacing the batteries of the line laser



It is not allowed to open, modify or to remove protective covers or housings except for battery change. Observe the maintenance instructions (see chap. 10.1.1, p. 47).

1. Loosen the threaded pin M6x5 (3) (Code 445 001 210) of the laser holder by using Allen key (Code 024 387 003) to remove the laser from the cover plate.
2. Unscrew the line laser and replace the batteries (4) (Pack with 10 button cells, 1.5 V = Code 790 142 124).
3. Screw the parts of the line laser together.
4. Place the line laser back into the holder, align and retighten with the threaded pin M6x5 (3).

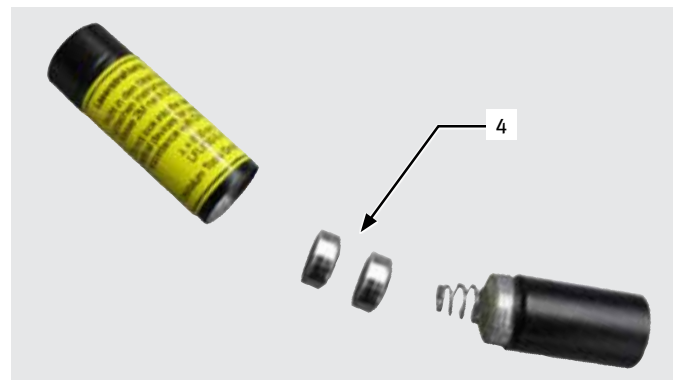
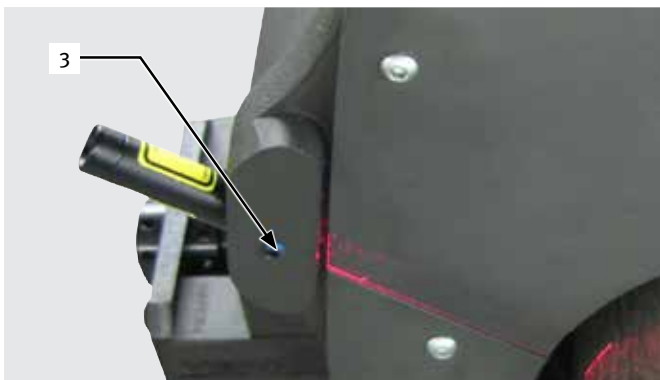

8.4 GF 4 and GF 6: fitting the clamping jaws

Clamping jaw characteristics, see chap. 4.2, p. 19.

8.4.1 Fitting the clamping jaws

1. Loosen the hexagon bolt (1) on the side of the vice of the GF 4 using a multifunctional wrench (2) and on the GF 6 with an SW8 socket head key.
2. Insert the clamping jaws.
3. Tighten hexagon bolts (1).

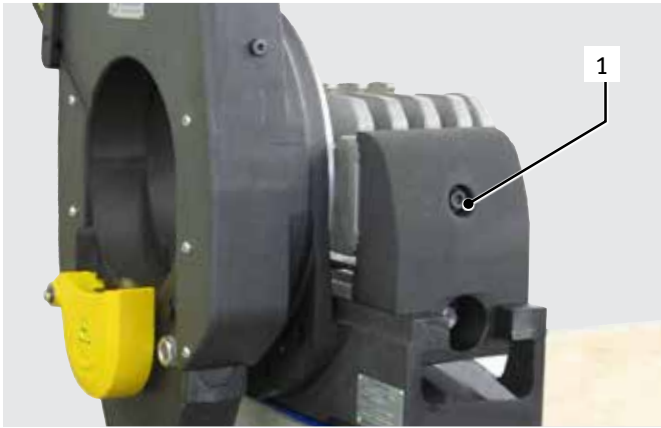

8.5 Fitting the saw blade, bevel cutter, additional cutters



WARNING

When switching the motor on, the pipe cutter may revolve around the pipe automatically.

Diverse physical injuries and material damage.

- ⊘ In their home position, the saw blade or bevel cutter must **not** touch the pipe.
- ▶ Make sure that the slide housing is in the home position when the cutting process starts.
- ▶ Clamp the pipe to be cut into the vice.
- ▶ Pull off the hand wheel from the spindle before the slide housing starts rotating.
- ▶ Before switching the motor on, make sure that the gap between the saw blade/bevel cutter and the pipe is sufficient, and that the pipe is securely clamped in the vice.
- ▶ Place sufficient supports under the tube.



WARNING

Flying parts/breaking tool!

Diverse physical injuries and material damage.

- ⊘ **Do not** process the pipe while it is loose in the vice.
- ⊘ **Never** use a damaged or deformed saw blade or bevel cutter.
- ⊘ In the event of tool breakage with a new tool, do **not** enter the old cut because the tool can break again (for details of what to do in the event of tool breakage, see chap. 10.4.1, p. 48).
- ▶ Clamp the pipe to be cut into the vice.
- ▶ Immediately replace worn-out tools.
- ▶ Ensure that the cutting tools are correctly fitted.
- ▶ Pipe dimension must be set correctly. During cutting, the saw blade must saw through the entire pipe wall.
- ▶ Avoid breaking tool through low (adequate) feed force, correct dimension (see chap. 8.6, p. 32) and speed (see chap. 8.7, p. 35) settings.
- ▶ Hold on to the motor unit tightly by the handle, and guide it with low (adequate) feed force during the machining process.

ATTENTION

Damage to material!

- ⊘ When using an additional cutter, only use the special Orbitalum Tools clamping plate (code 790 046 188); **not** the clamping plate supplied as standard with the cutters.
- ⊘ **Never** use a damaged or deformed saw blade or bevel cutter.
- ▶ The saw blade or bevel cutter must be free from chips and dirt.
- ▶ Only use original tools by Orbitalum Tools.
- ▶ Mount the saw blade/bevel cutter or additional cutter with the inscription facing you. The teeth will then be pointing in the correct direction.

IMPORTANT Before fitting the saw blade or bevel cutter: Move the slide (9) all the way down using the hand wheel (8).

8.5.1 Inserting the saw blade or bevel cutter

1. Turn the chip guard (1) down for approx. 90°.
2. Loosen the hexagon nut (4). Remove the clamping plate (3) and the saw blade (2).
3. Clean the saw blade shaft (6) and vicinity with a brush.
4. Fit the saw blade (2) or bevel cutter and the clamping plate (3).
5. Tighten the hexagon nut (4) a fraction.
6. Move the saw chip guard (1) back to its original position.



NOTE Make sure that the felt ring (7) is on the locking sleeve.

8.5.2 Inserting the saw blade/bevel cutter combination

1. Turn the chip guard (1) down for approx. 90°.
2. Loosen the hexagon nut (5). Remove the clamping plate and the saw blade.
3. Clean the saw blade shaft (6) and vicinity with a brush.
4. Fit the additional cutter (2), the saw blade (3) and the special clamping plate (4).
5. Tighten the hexagon nut (5) a fraction.
6. Move the saw chip guard (1) back to its original position.

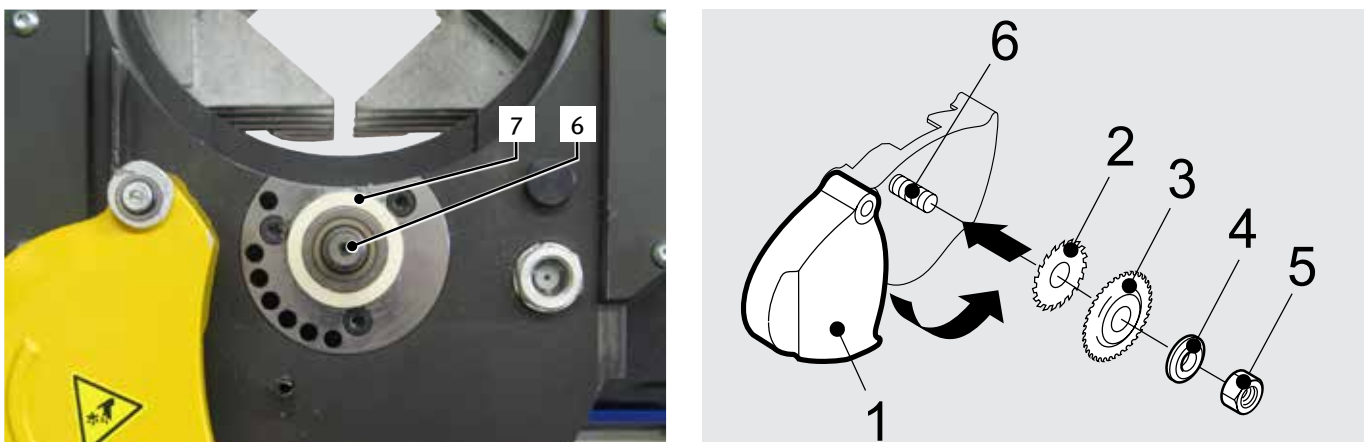

NOTE Make sure that the felt ring (7) is on the locking sleeve.

8.6 Adjusting the pipe dimension

NOTE We recommend supporting pipes longer than 1 m with a pipe feeder or extension unit (see chap. 8.1.3, p. 28).

8.6.1 Saw blade without additional cutter

1. Turn the slide with saw blade all the way down using the hand wheel (1).
2. Insert the pipe so that it almost reaches the saw blade (3) and tighten using the multifunctional wrench (4).

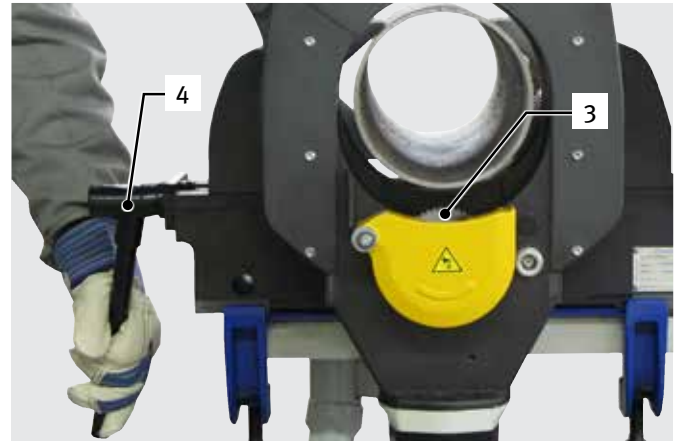

3. Use the handle to turn the motor upwards for about 30° (clockwise) until the saw blade is in cutting position.
4. Turn the hand wheel (1) until the teeth of the saw blade (3) protrude about 1 to 2 mm (0.039 - 0.079 inch) inside the pipe (2).
5. If desired, perform a test cut (cutting the pipe, see chap. 9.1.3, p. 38 for machines with AVM, chap. 9.2.2, p. 40 for machines with MVM and chap. 9.3.2, p. 43 for working without AVM/MVM), check the cut result and readjust the hand wheel (1) if necessary.
6. Turn the motor back to its home position.

When working with the AVM: Hold down the STOP button (6), and pivot the motor back into the normal position.

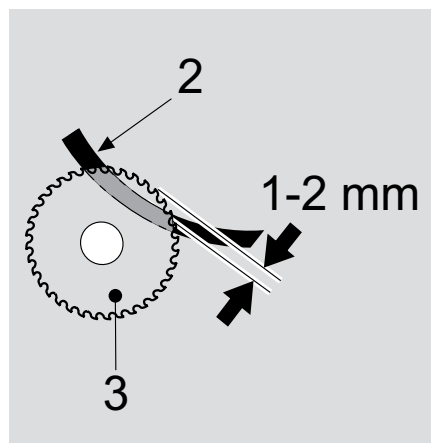
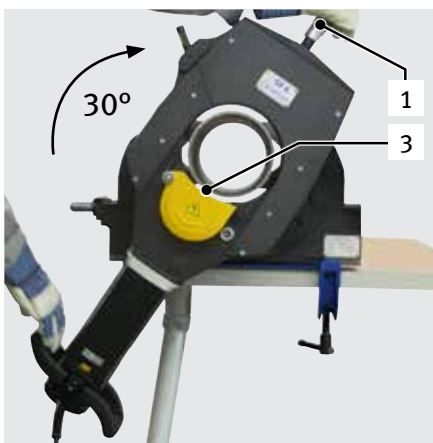

NOTE Scale of the hand wheel: a readjustment by one graduation mark results in a radial feed or bevel alteration of 0.1 mm (0.004 inch), for the GF 6 of 0.2 mm (0.008 inch).

8.6.2 Saw blade with additional cutter

1. Turn the slide with the saw blade and additional cutter (2) all the way down using the hand wheel (1).
2. Insert the pipe so that it almost reaches the additional cutter (2) and tighten using the multifunctional wrench (4).

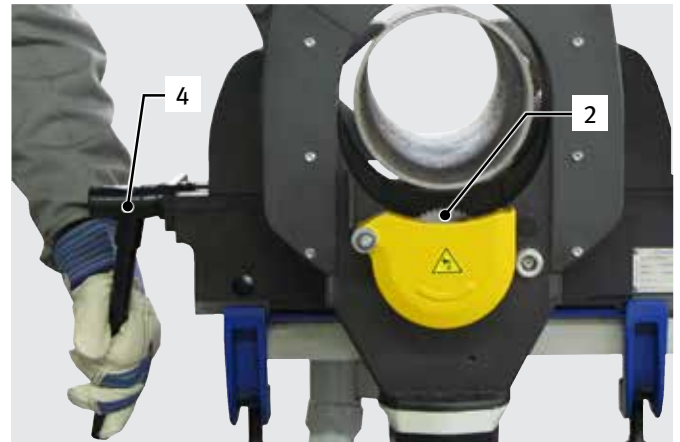

3. Use the handle to turn the motor upwards for about 30° until the saw blade is in cutting position.
4. Turn the hand wheel (1) until the teeth of the additional cutter (2) cover the wall thickness of the pipe.
5. If desired, perform a test cut (Cutting and beveling the pipe, see chap. 9.1.5, p. 39 for machines with AVM, chap. 9.2.4, p. 42 for machines with MVM and chap. 9.3.4, p. 45 for working without AVM/MVM), check the cut and bevel and readjust the hand wheel (1) if necessary.
6. Turn the motor back to its home position.

When working with the AVM: Hold down the STOP button (6), and pivot the motor back into the normal position.

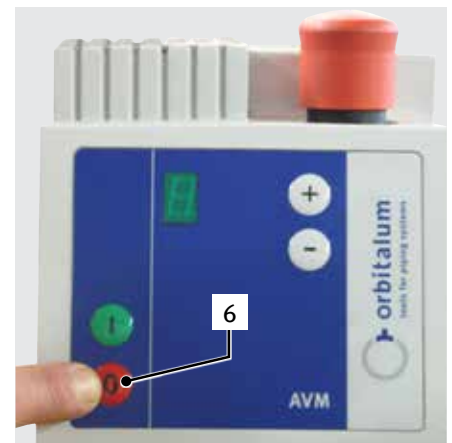
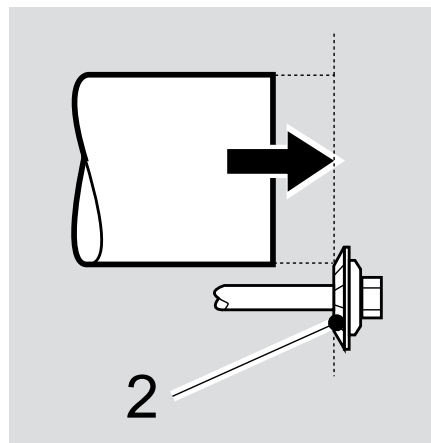
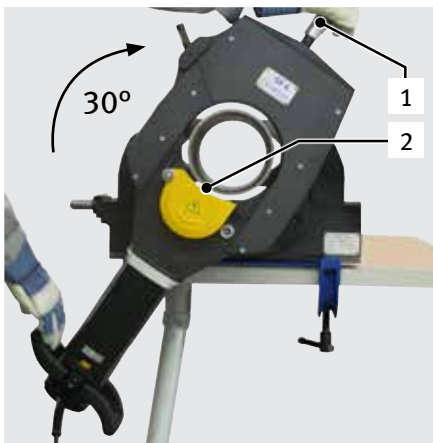

NOTE Scale of the hand wheel: a readjustment by one graduation mark results in a radial feed or bevel alteration of 0.1 mm (0.004 inch), for the GF 6 of 0.2 mm (0.008 inch).

8.6.3 Adjusting the bevel cutter

1. Turn the slide with the bevel cutter (2) all the way down using the hand wheel (1).
2. Insert the pipe so that it almost reaches the bevel cutter (2). The pipe must not project over the cutter. Tighten using the multifunctional wrench (3).

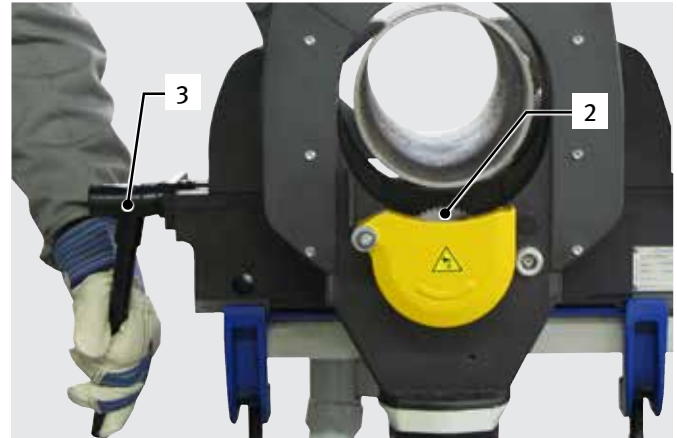

3. Use the handle to turn the motor upwards for about 30° until the bevel cutter is in beveling position.
4. Turn the hand wheel (1) until the teeth of the bevel cutter (2) cover the wall thickness of the pipe and the desired beveling position is reached.
5. If desired, perform a test bevel (beveling the pipe, see chap. 9.1.4, p. 39 for machines with AVM, chap. 9.2.3, p. 41 for machines with MVM and chap. 9.3.3, p. 44 for working without AVM/MVM), check the bevel and readjust the hand wheel (1) if necessary.
6. Turn the motor back to its home position.

When working with the AVM: Hold down the STOP button (6), and pivot the motor back into the normal position.

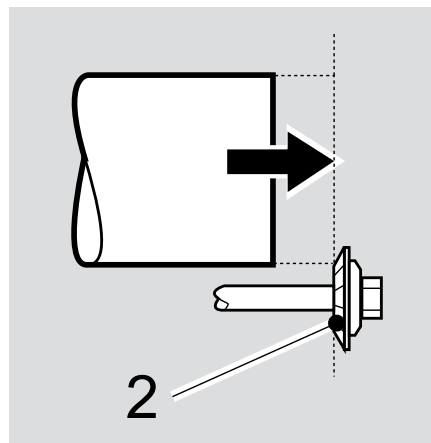
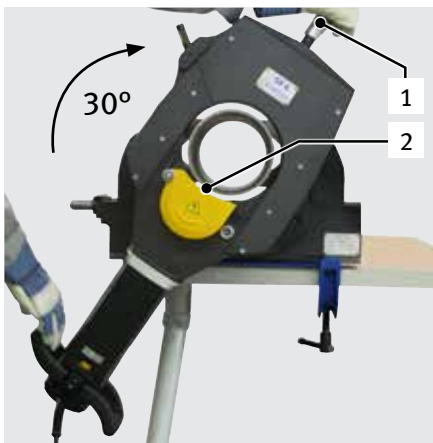



NOTE Scale of the hand wheel: a readjustment by one graduation mark results in a radial feed or bevel alteration of 0.1 mm (0.004 inch), for the GF 6 of 0.2 mm (0.008 inch).



8.7 Selecting the motor speed

NOTE Select low power speed for tough and high-strength materials and large wall thickness.

8.7.1 Standard values for spindle speed and feed force level (AVM)

Pipe material	RPM control setting (1)	Spindle speed (rpm)	Force feed level AVM*  
High-alloy high-quality steels	1 - 2	40 - 65	L - 2
Low-alloy high-quality steels	2 - 4	150	L - 4
Structural steel	4 - 6	215	5 - 9

* The feed force level and spindle speed may be varied depending on the thickness and diameter of the pipe wall.

- IMPORTANT NOTES REGARDING AVM**
- ▶ When first starting to process the pipe with the AVM, a low feed force level is recommended which may be increased later. Higher levels result in a higher chip production and possibly also in a higher wear of tools. The intelligent control system of the AVM monitors the feed force continuously depending on the torque and the parameter settings.
 - ▶ When cutting thin-walled pipes (wall thickness 3 - 5 mm), always start with level 1 and select a higher level afterwards.
 - ▶ Select the feed force level (L - 9) using the / buttons on the AVM display (for standard values, see the table above).



9. OPERATION



DANGER

Machine start-up due to unintentional pressing of the ON/OFF switch!

Fatal electric shock.

Diverse physical injuries and material damage.

- ▶ At the end of each working cycle, before transportation, changing tools, cleaning and performing any maintenance, adjustment or repair work, switch off the machine, allow it to run to a stop and pull the mains plug.



DANGER

When the slide housing is rotating, excess lubricant can get into the motor unit!

Fatal electric shock.

- ▶ Remove excess lubricant from the machine after every step.



DANGER

Unexpected start-up!

Serious injury or death.

- ▶ Before connecting the machine to the power supply, check the on/off switch is switched off.



DANGER

Loose/baggy clothing, long hair or jewelry can get caught in rotating machine parts!

Serious injury or death.

- ▶ Wear tight-fitting clothing when using the machine.
- ▶ Tie up long hair to prevent it from being caught.



WARNING

Flying parts/breaking tool!

Diverse physical injuries and material damage.

- ⊘ **Do not** process the pipe while it is loose in the vice.
- ⊘ **Never** use a damaged or deformed saw blade or bevel cutter.
- ⊘ In the event of tool breakage with a new tool, do **not** enter the old cut because the tool can break again (for details of what to do in the event of tool breakage, see chap. 10.4.1, p. 48).
- ▶ Clamp the pipe to be cut into the vice.
- ▶ Immediately replace worn-out tools.
- ▶ Ensure that the cutting tools are correctly fitted.
- ▶ Pipe dimension must be set correctly. During cutting, the saw blade must saw through the entire pipe wall.
- ▶ Avoid breaking tool through low (adequate) feed force, correct dimension (see chap. 8.6, p. 32) and speed (see chap. 8.7, p. 35) settings.
- ▶ Hold on to the motor unit tightly by the handle, and guide it with low (adequate) feed force during the machining process.



WARNING

Risk of machine and pipe falling!

Irreversible crushing.

- ▶ Check the machine's position and secure it so it cannot fall.
- ▶ Place sufficient supports under the tube.



WARNING

Trapped fingers between the vice/clamping shell and pipe!

Irreversible crushing.

- ⊘ **Do not** insert fingers between the vice/clamping shell and pipe!



WARNING

Body parts can fit between the cutting tools and the pipe!

Serious injury.

- ⊘ **Do not** place body parts between the cutting tools and the pipe.



WARNING

Flying, hot and sharp-edged chips, pipe surfaces, cutting edges and tools!

Danger of injury to eyes and hands.

- ⊘ **Do not** reach into the rotating tool during working.
- ⊘ **Never** work without the saw chip guard mounted.
- ▶ Wear recommended protective clothing.
- ▶ At the end of each working cycle switch off the machine, allow it to run to a stop and pull the mains plug. Remove chips with tightfitting safety gloves (in accordance with DIN EN 388 and EN 407) using suitable tools (e.g. tongs or screwdriver).
- ▶ Make sure the chips guard is working.



ATTENTION

Restarting the machine following blockage!

Diverse physical injuries and material damage.

- ▶ In the event of a blockage, always disconnect the machine from the power supply before clearing it.
- ▶ If necessary, remove any tensioned parts before restarting the machine.



ATTENTION

Vapors when working with lubricants!

Damage to lungs, skin and the environment.

- ▶ Only use original lubricant recommended by Orbitalum Tools.

9.1 Processing the pipe with AVM

For more information on pipe processing with MVM, see from chap. 9.2, p. 40.

For manual operation without AVM or MVM, see from chap. 9.3, p. 43.

IMPORTANT

Only operate AVM in combination with the Orbitalum Tools pipe cutters GF 4, GF 6, RA 8 or RA 12.

- ⊘ Do **not** connect any other devices to the socket of the AVM.

9.1.1 Shutting down (even in an emergency)



DANGER

EMERGENCY STOP function not available by unplugging the power plug!

Diverse physical injuries and material damage.

- ⊘ Do **not** use angled power plugs.
- ⊘ Do **not** use click-in socket outlets and click-in power plugs (blue CEE power plugs) for power connection, otherwise the EMERGENCY STOP does not function. The user must check whether the power plug can be pulled out of the outlet by the cable.
- ▶ Only use original Orbitalum Tools parts.
- ▶ Ensure free access to the power plug.

IMPORTANT

EMERGENCY STOP button (12) on the AVM: Only press in an emergency. Pressing the EMERGENCY STOP button (13) interrupts the power supply. Unlock the button to restart.



- ▶ Activate by switching the ON/OFF toggle switch (13). If the ON/OFF toggle switch (13) fails to work, remove the plug from the socket or vacate the danger zone as quickly as possible and then remove the plug.

9.1.2 Initial operation



1. Connect the pipe cutter to the socket (1) of the AVM.
2. Connect the mains cable of the AVM to the main power supply.

9.1.3 Cutting the pipe with AVM

IMPORTANT If the pipe cutter was out of operation for a relatively long time:

- ▶ Swivel the cutter motor by 180°.
- ▶ Switch on the AVM and the pipe cutter (see chap. 9.1.2, p. 38), let the cutter motor run for about 10 seconds.

This relubricates all gear components.

1. Adjust the pipe dimension (see chap. 8.6, p. 32).
2. Adjust the saw blade to the pipe dimension (see chap. 8.6, p. 32).
3. If necessary, tighten the hexagon nut of the saw blade fixture a fraction (see from chap. 8.5, p. 30).
4. Adjust the spindle speed and the feed force level (for standard values, (see chap. 8.7.1, p. 35).
5. Push the pipe through the vice up to the desired length and clamp it securely.
Support pipes longer than 1 m using a pipe feeder (see chap. 8.1.3, p. 28).

IMPORTANT Pull off the vice handle from the spindle before the slide housing starts rotating.

6. Apply saw blade lubricant to the saw blade:

Recommendation:

- up to 2": at least every 3 cuts,
- over 2" and with chrome and high-quality steel pipes: prior to every cut.

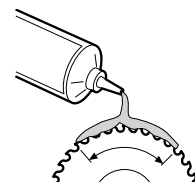

NOTE Use only saw blade lubricant (no oils) from Orbitalum Tools (e.g. GF LUB or GF TOP).
Keep the machine clean. Always remove residue from lubricant from the machine.

NOTE For continuous operation: after cutting loosen the hexagon nut on the saw blade to avoid damage caused by tension.

7. Switch pipe cutter on.
8. Press the  START button.

This starts the pipe processing. The cutter automatically shuts off after the complete cut has been made.

9.1.4 Beveling the pipe with AVM

IMPORTANT If the pipe cutter was out of operation for a relatively long time:

- ▶ Swivel the cutter motor by 180°.
- ▶ Switch on the AVM and the pipe cutter (see chap. 9.1.2, p. 38), let the cutter motor run for about 10 seconds.

This relubricates all gear components.

1. Adjust the pipe dimension (see chap. 8.6, p. 32).
2. Adjust the bevel cutter to the pipe dimension (see chap. 8.6, p. 32).
3. If necessary, tighten the hexagon nut of the bevel cutter fixture a fraction (see from chap. 8.5, p. 30).
4. Adjust the spindle speed and the feed force level (for standard values (see chap. 8.7.1, p. 35)).
5. Push the pipe through the vice up to the desired length and clamp it securely.
Support pipes longer than 1 m using a pipe feeder (see chap. 8.1.3, p. 28).

IMPORTANT Pull off the vice handle from the spindle before the slide housing starts rotating.

6. Apply saw blade lubricant to the bevel cutter:
Recommendation:
 - up to 2": at least every 3 cuts,
 - over 2" and with chrome and high-quality steel pipes: prior to every cut.

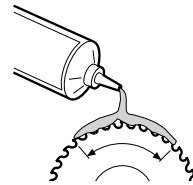

NOTE Use only saw blade lubricant (no oils) from Orbitalum Tools (e.g. GF LUB or GF TOP).
Keep the machine clean. Always remove residue from lubricant from the machine.

NOTE For continuous operation: after beveling, loosen the hexagon nut on the bevel cutter to avoid damage caused by tension.

7. Switch pipe cutter on.
8. Press the  START button.

This starts the pipe processing. The cutter automatically shuts off after the correct bevel has been cut.

9.1.5 Cutting and beveling pipes simultaneously

- Pipes with a wall thickness of up to 7 mm (0.276 inch) can be simultaneously cut and beveled.
- If using an additional cutter, the cutter motor has to be turned around the pipe more slowly than during normal cutting, as two tools are being used at the same time. The procedure is the same as described in chap. 9.1.3, p. 38.

NOTE

- If necessary, lubricate the saw blade and the additional cutter again during work.
- For continuous operation: after cutting, loosen the hexagon nut on the saw blade to avoid damage caused by tension.
- The evenness of the bevel height depends on the roundness of the pipe.

9.2 Processing the pipe with MVM

For more information on pipe processing with AVM, see from chap. 9.1, p. 37.

For manual operation without AVM or MVM, see from chap. 9.3, p. 43.

9.2.1 Shutting down (even in an emergency)



DANGER

EMERGENCY STOP function not available by unplugging the power plug!

Diverse physical injuries and material damage.

- ⊘ Do not use angled power plugs.
- ⊘ Do not use click-in socket outlets and click-in power plugs (blue CEE power plugs) for power connection, otherwise the EMERGENCY STOP does not function. The user must check whether the power plug can be pulled out of the outlet by the cable.
- ▶ Only use original Orbitalum Tools parts.
- ▶ Ensure free access to the power plug.



- ▶ Activate by switching the ON/OFF toggle switch (12). If the ON/OFF toggle switch (12) fails to work, remove the plug from the socket or vacate the danger zone as quickly as possible and then remove the plug.

9.2.2 Cutting the pipe with MVM

IMPORTANT If the pipe cutter was out of operation for a relatively long time:

- ▶ Turn the cutter motor by 180°.
- ▶ Switch the pipe cutter on and let it run for about 10 seconds.

This relubricates all gear components.

1. Adjust the pipe dimension (see chap. 8.6, p. 32).
2. Adjust the saw blade to the pipe dimension (see chap. 8.6.1, p. 32).
3. If necessary, tighten the hexagon nut of the saw blade fixture a fraction (see from chap. 8.5, p. 30).
4. Adjust the spindle speed (see chap. 8.7.1, p. 35).
5. Push the pipe through the vice up to the desired length and clamp it securely. Support pipes longer than 1 m using a pipe feeder (see chap. 8.1.3, p. 28).

IMPORTANT Pull off the vice handle from the spindle before the slide housing starts rotating.

6. Apply saw blade lubricant to the saw blade:

Recommendation:

 - up to 2": at least every 3 cuts,
 - over 2" and with chrome and high-quality steel pipes: prior to every cut.

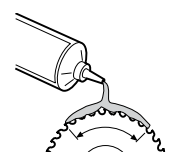

- | | |
|------|--|
| NOTE | Use only saw blade lubricant (no oils) from Orbitalum Tools (e.g. GF LUB or GF TOP).
Keep the machine clean. Always remove residue from lubricant from the machine. |
| NOTE | For continuous operation: after cutting loosen the hexagon nut on the saw blade to avoid damage caused by tension. |



7. Switch pipe cutter on.
8. Carefully turn the hand wheel (1) of the MVM clockwise until the pipe wall has been pierced through.
9. Continue turning steadily until the pipe has been cut off.
10. Switch the motor off and allow the machine to run to a stop.

9.2.3 Beveling the pipe with MVM

- | | |
|-----------|---|
| IMPORTANT | If the pipe cutter was out of operation for a relatively long time: <ul style="list-style-type: none"> ▶ Turn the cutter motor by 180°. ▶ Switch the pipe cutter on and let it run for about 10 seconds. This relubricates all gear components. |
|-----------|---|

1. Adjust the pipe dimension (see chap. 8.6, p. 32).
2. Adjust the bevel cutter to the pipe dimension (see chap. 8.6.3, p. 34).
3. If necessary, tighten the hexagon nut of the bevel cutter fixture a fraction (see from chap. 8.5, p. 30).
4. Adjust the spindle speed (see chap. 8.7.1, p. 35).
5. Push the pipe through the vice up to the desired length and clamp it securely.
Support pipes longer than 1 m using a pipe feeder (see chap. 8.1.3, p. 28).

- | | |
|-----------|---|
| IMPORTANT | Pull off the vice handle from the spindle before the slide housing starts rotating. |
|-----------|---|

6. Apply saw blade lubricant to the bevel cutter:

Recommendation:

 - up to 2": at least every 3 cuts,
 - over 2" and with chrome and high-quality steel pipes: prior to every cut.

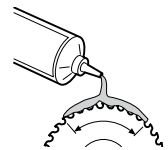

- | | |
|------|--|
| NOTE | Use only saw blade lubricant (no oils) from Orbitalum Tools (e.g. GF LUB or GF TOP).
Keep the machine clean. Always remove residue from lubricant from the machine. |
| NOTE | For continuous operation: after beveling, loosen the hexagon nut on the bevel cutter to avoid damage caused by tension. |



7. Switch pipe cutter on.
8. Carefully turn the hand wheel (1) of the MVM clockwise until the pipe wall has been pierced through.
9. Continue turning steadily until the pipe has been beveled completely.
10. Switch the motor off and allow the machine to run to a stop.

9.2.4 Cutting the pipe with MVM and beveling it simultaneously

- Pipes with a wall thickness of up to 7 mm (0.276 inch) can be simultaneously cut and beveled.
- If using an additional cutter, the cutter motor has to be turned around the pipe more slowly than during normal cutting, as two tools are being used at the same time. The procedure is the same as described in chap. 9.2.2, p. 40.

-
- | | |
|------|---|
| NOTE | <ul style="list-style-type: none"> • If necessary, lubricate the saw blade and the additional cutter again during work. • For continuous operation: after cutting, loosen the hexagon nut on the saw blade to avoid damage caused by tension. • The evenness of the bevel height depends on the roundness of the pipe. |
|------|---|
-

9.3 Processing the pipe manually

For more information on pipe processing with AVM, see from chap. 9.1, p. 37.

For more information on pipe processing with MVM, see from chap. 9.2, p. 40.

9.3.1 Shutting down (even in an emergency)



DANGER

EMERGENCY STOP function not available by unplugging the power plug!

Diverse physical injuries and material damage.

- ⊘ Do not use angled power plugs.
- ⊘ Do not use click-in socket outlets and click-in power plugs (blue CEE power plugs) for power connection, otherwise the EMERGENCY STOP does not function. The user must check whether the power plug can be pulled out of the outlet by the cable.
- ▶ Only use original Orbitalum Tools parts.
- ▶ Ensure free access to the power plug.



- ▶ Activate by switching the ON/OFF toggle switch (12). If the ON/OFF toggle switch (12) fails to work, remove the plug from the socket or vacate the danger zone as quickly as possible and then remove the plug.

9.3.2 Cutting the pipe manually

IMPORTANT If the pipe cutter was out of operation for a relatively long time:

- ▶ Turn the cutter motor by 180°.
- ▶ Switch the pipe cutter on and let it run for about 10 seconds.

This relubricates all gear components.

1. Adjust the pipe dimension (see chap. 8.6, p. 32).
2. Adjust the saw blade to the pipe dimension (see chap. 8.6.1, p. 32).
3. If necessary, tighten the hexagon nut of the saw blade fixture a fraction (see from chap. 8.5, p. 30).
4. Adjust the spindle speed (see chap. 8.7.1, p. 35).
5. Push the pipe through the vice up to the desired length and clamp it securely. Support pipes longer than 1 m using a pipe feeder (see chap. 8.1.3, p. 28).

IMPORTANT Pull off the vice handle from the spindle before the slide housing starts rotating.

6. Apply saw blade lubricant to the saw blade:

Recommendation:

 - up to 2": at least every 3 cuts,
 - over 2" and with chrome and high-quality steel pipes: prior to every cut.

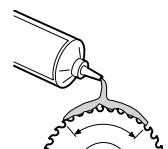

-
- NOTE** Use only saw blade lubricant (no oils) from Orbitalum Tools (e.g. GF LUB or GF TOP). Keep the machine clean. Always remove residue from lubricant from the machine.
-
- NOTE** For continuous operation: after cutting loosen the hexagon nut on the saw blade to avoid damage caused by tension.
-

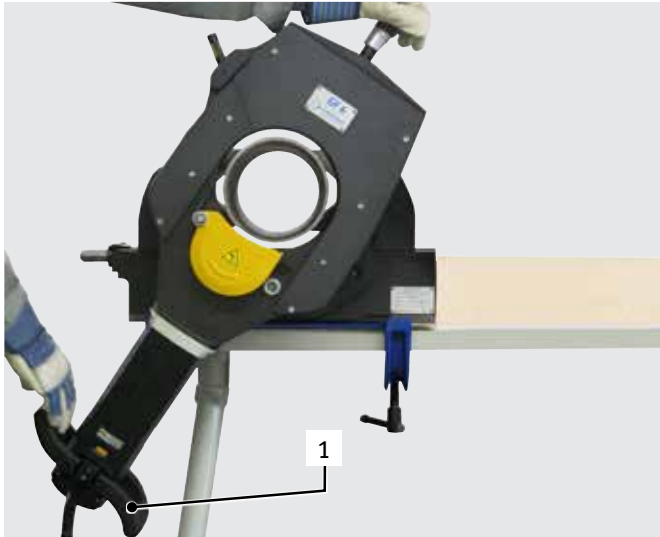

7. Switch the motor on.
8. Carefully turn the motor clockwise using the handle (1) until the pipe wall has been pierced through.
9. Continue turning steadily until the pipe has been cut off.
10. Switch the motor off and allow the machine to run to a stop.

9.3.3 Beveling the pipe manually

IMPORTANT If the pipe cutter was out of operation for a relatively long time:

- ▶ Turn the cutter motor by 180°.
- ▶ Switch the pipe cutter on and let it run for about 10 seconds.

This relubricates all gear components.

1. Adjust the pipe dimension (see chap. 8.6, p. 32).
2. Adjust the bevel cutter to the pipe dimension (see chap. 8.6.3, p. 34).
3. If necessary, tighten the hexagon nut of the bevel cutter fixture a fraction (see from chap. 8.5, p. 30).
4. Adjust the spindle speed (see chap. 8.7.1, p. 35).
5. Push the pipe through the vice up to the desired length and clamp it securely. Support pipes longer than 1 m using a pipe feeder (see chap. 8.1.3, p. 28).

IMPORTANT Pull off the vice handle from the spindle before the slide housing starts rotating.

6. Apply saw blade lubricant to the bevel cutter:
 Recommendation:
 - up to 2": at least every 3 cuts,
 - over 2" and with chrome and high-quality steel pipes: prior to every cut.

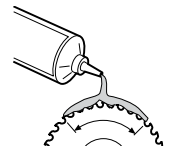

-
- NOTE** Use only saw blade lubricant (no oils) from Orbitalum Tools (e.g. GF LUB or GF TOP). Keep the machine clean. Always remove residue from lubricant from the machine.
-
- NOTE** For continuous operation: after beveling, loosen the hexagon nut on the bevel cutter to avoid damage caused by tension.
-

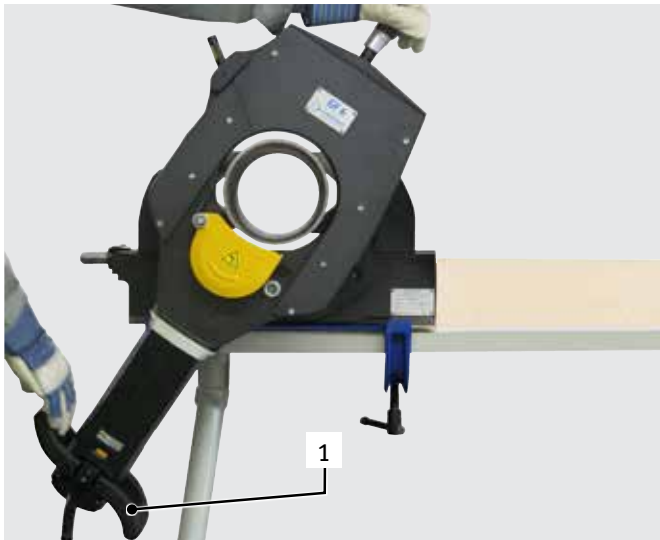

7. Switch the motor on.
8. Carefully turn the motor clockwise using the handle (1) until the pipe wall has been pierced through.
9. Continue turning steadily until the pipe has been beveled completely.
10. Switch the motor off and allow the machine to run to a stop.

9.3.4 Cutting the pipe manually and beveling it simultaneously

- Pipes with a wall thickness of up to 7 mm (0.276 inch) can be simultaneously cut and beveled.
- If using an additional cutter, the cutter motor has to be turned around the pipe more slowly than during normal cutting, as two tools are being used at the same time. The procedure is the same as described in chap. 9.3.2, p. 43.

NOTE

- If necessary, lubricate the saw blade and the additional cutter again during work.
 - For continuous operation: after cutting, loosen the hexagon nut on the saw blade to avoid damage caused by tension.
 - The evenness of the bevel height depends on the roundness of the pipe.
-

10. SERVICING, MAINTENANCE, TROUBLESHOOTING

NOTE Some of the work mentioned depends a great deal on the use and on the ambient conditions. The cycles specified are minimum specifications. In individual cases, differing maintenance cycles are possible. To ensure the safety of the machine, perform maintenance annually using an authorized service center with VDE testing. If the machine does not function as previously described, the machine must also be sent into an authorized service center.

DANGER  **Danger of death by electric shock!**
 Non-observance could result in death or serious injury.

- ▶ At the end of each working cycle, before transportation, changing tools, cleaning and performing any maintenance, adjustment or repair work, switch off the machine, allow it to run to a stop and pull the mains plug.

DANGER  **Risk of electric shock due to poor electrics!**
 Fatal electric shock.

- ▶ At the end of each working cycle, before transportation, changing tools, cleaning and performing any maintenance, adjustment or repair work, switch off the machine, allow it to run to a stop and pull the mains plug.
- ▶ Repair and maintenance work on the electrical equipment may only be carried out by a qualified electrician.

10.1 Maintenance

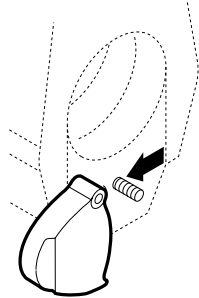
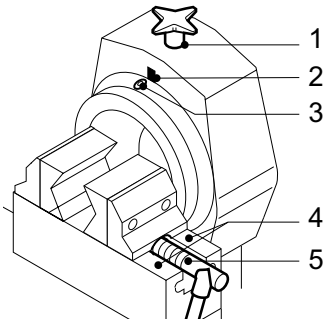
Interval	Activity	
Before starting work	<ul style="list-style-type: none"> ▶ Remove chips and dirt from the saw blade. ▶ Keep the vent holes free from chips. ▶ Check the oil level of the gear and top up if necessary (see chap. 10.2, p. 47). ▶ Make sure that the felt ring (1) is on the locking sleeve, replace if necessary. Felt ring for GF 4, GF 6, RA 8, RA 12: Code 790 046 168. 	
Every time the cutter is cleaned Every time the tool is changed	<ul style="list-style-type: none"> ⊘ Do not use compressed air to clean the area at the end of the shaft marked with an arrow as the rotary shaft seal may otherwise be damaged by chips. ▶ Use a cloth or brush to clean the end of the shaft. 	
Every week	<ul style="list-style-type: none"> ▶ Clean and oil: <ul style="list-style-type: none"> • The spindle of the hand wheel (1) • The sliding block (2) • The guide bush (3) • Vice tracks (4) • Vice spindle (5) 	

10.1.1 Line laser

- ▶ Own maintenance work on the laser is not permitted.
- ▶ The laser is to be returned to the factory for any maintenance or repair work that may be required.
- ▶ It is not allowed to open, modify or to remove protective covers or housings except for battery change.

10.2 Checking the oil level of the gear and topping up

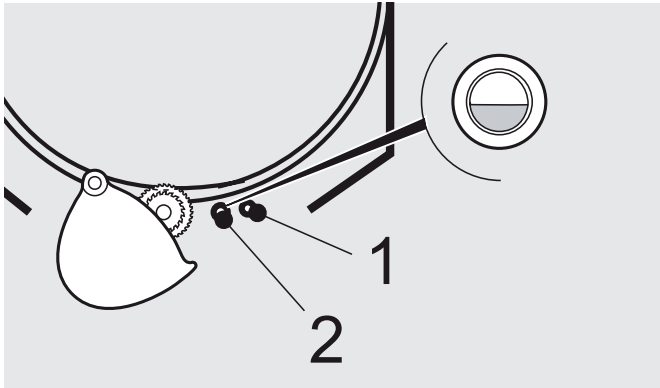

The gears of the pipe cutters have an oil level indicator. The oil level should be visible in the middle of the inspection glass.

1. Check the oil level through the inspection glass (2) and top up if necessary.
2. To top up: unscrew the oil filler screw (1). Fill with special Orbitalum Tools gear oil.
3. Re-insert and tighten the oil filler screw.

10.3 Cleaning the slide guide



WARNING

Danger of being injured by a not sufficiently secured slide!

- ⊘ **Never** dismount the slide by pulling it downwards.
- ▶ Always tighten the safety screw when assembling the slide.

1. Remove the safety screw (1).
2. Turn the slide housing upwards by 180°.
3. Turn the hand wheel (2) counterclockwise.
4. Pull out the slide (3) with the motor upwards.
5. Clean the guides of the slide housing and slide. Lightly lubricate both parts using HD 30 engine oil.
6. Remount the slide. Insert and tighten the safety screw (1).



Position of the safety screw for the GF 4 and GF 6 (AVM/MVM).



Position of the safety screw for the RA 6, RA 8, RA 12 (AVM/MVM).

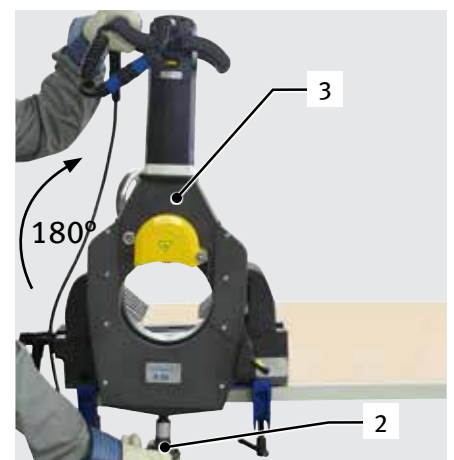

10.4 What to do if? – General trouble-shooting

Problem	Possible cause	Remedy
The motor is not running.	The overload protection relay has tripped.	▶ With the switch on "0", switch the pipe cutter back on and allow to run at idle for about 1 minute.
	The restart inhibitor has tripped.	▶ Set the switch to "0", then switch the pipe cutter back on.
The pipe cutter will not turn.	Pipe diameter not correctly set.	▶ Set the pipe dimension correctly (see chap. 8.6, p. 32).
The saw blade is not cutting and is slipping through.	Hexagon nut on the saw blade shaft not tightened.	▶ Tighten the hexagon nut.
The saw blade is not cutting.	The saw blade has been inserted the wrong way round.	▶ Insert the saw blade correctly. The labelling of the saw blade must be visible when viewed from the front of the machine.
It is no longer possible to set the pipe dimension.	The slide guide is dirty.	▶ Clean the slide guide (see chap. 10.3, p. 47).
The feeder does not start.	Feed force level or motor speed too low.	▶ Increase feed force level or motor RPMs.
Tool breakage.	Feed rate and cutting speed too high.	▶ See chap. 10.4.1, p. 48 for details of the remedy.

10.4.1 What to do in the event of tool breakage

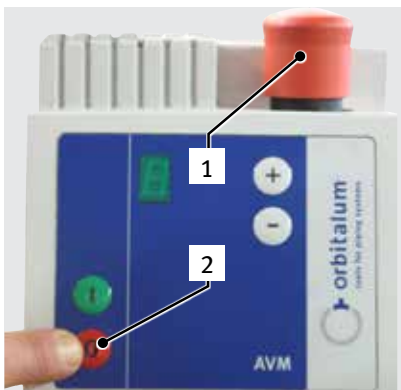

- ⊘ Stop the machine.
- ▶ Press the EMERGENCY STOP button (1), remove the mains plug and undo the hexagon nut on the saw blade.
- ▶ Reinsert the mains plug and engage the EMERGENCY STOP button (1).
- ▶ Keep pressing the red stop button (2) on the AVM and, if required, turn the machine back to its starting position with additional assistance (another person).
- ▶ Fit a new tool; remove the mains plug before replacing the tool, see from chap. 8.5, p. 30 ff for details of saw blade milling cutter fitting).

NOTE If a new tool breaks, do not enter the old cut as the tool can break again.

10.5 Error messages/trouble-shooting AVM

In case of faults concerning the AVM, the machine will stop automatically. The display will flash at 1-second intervals, alternately showing "F" and a figure from 1 to 6. Before restarting the AVM, it has to be disconnected from the mains supply by pressing the EMERGENCY OFF button or by pulling the mains plug.

Error message/fault	Possible cause	Remedy
Alert F1: Cutter motor overload.	Feed force level too high.	▶ Select a lower feed force level.
Alert F2: Feed motor overload.	Feed force level too high.	▶ Select a lower feed force level.
	Pipe dimension not correctly set.	▶ Set the pipe dimension correctly (see chap. 8.6, p. 32).
	Chips between slide housing and pipe.	▶ Remove the chips.
	The slide housing is running sluggishly.	▶ Make the slide housing run smoothly.
Alert F3: The cutter motor stops during processing.	Obstacle in the swiveling range.	▶ Remove the obstacle.
	Power supply of the cutter motor interrupted.	▶ Check the connecting cable and the plug connections.
Alert F4: Internal control error.	The overload protection relay of the cutter motor has tripped.	▶ With the switch on "0", switch the pipe cutter back on and allow to run at idle for about 1 minute.
	The processor is defective.	▶ Contact the service department.
Alert F5: Overheating.	The temperature of the control system is too high.	▶ Self-regulating after cooling down.
Alert F6: Internal control error.	Wrong basic setting.	▶ Contact the service department.
No alert: AVM does not start.	The cutter motor is not running or is not running long enough.	▶ The cutter motor must be running for at least 5 seconds before the AVM can be started.
The feed stops at the cut-in area.	Blocking by chips.	▶ Remove the chips.
	Pipe dimension not correctly set.	▶ Correct the adjustment.
	Saw blade worn out.	▶ Insert new saw blade.
The feed does not stop at the stop position. Display: No decimal point at the stop position.	Light barrier or reflector defective.	▶ Replace the defective parts (contact the service department, if necessary).
	Light barrier or reflector dirty.	▶ Clean the dirty parts.

After having remedied the cause of malfunction, the AVM has to be reconnected to the mains supply. After having switched off the cutter motor (to position "0"), it may be restarted.

10.6 Servicing/customer service

For ordering spare parts, refer to the separate spare parts list.
For troubleshooting, please contact the branch responsible directly.

Please indicate the following details:

- Type of machine:
 - GF 4, GF 4 AVM or GF 4 MVM
 - GF 6, GF 6 AVM or GF 6 MVM
 - RA 8, RA 8 AVM or RA 8 MVM
 - RA 12, RA 12 AVM or RA 12 MVM
- Machine no.: (*see type plate*)

11. EU DECLARATION OF CONFORMITY

11.1 GF 4, GF 6, RA 8, RA 12 (Standard/MVM)



EG-Konformitätserklärung
Declaration of conformity
Dichiarazione di conformità
Déclaration de conformité
Declaración de conformidad

Orbitalum Tools GmbH
Josef-Schüttler-Straße 17
78224 Singen, Deutschland
Tel.: +49 (0) 77 31 792-0
Fax: +49 (0) 77 31 792-524

As in appendix II A of the EC Machinery Directive 2006/42/EC and the EMC Directive 2014/30/EU

Die Bauart der Maschine:
The following product:
Il seguente prodotto:
Le produit suivant:
El producto siguiente:

GF 4 Pipe Cutting and Beveling Machine*
GF 4 MVM Pipe Cutting and Beveling Machine
with Manual Feed Module*
GF 6 Pipe Cutting and Beveling Machine*
GF 6 MVM Pipe Cutting and Beveling Machine
with Manual Feed Module*
RA 8 Pipe Cutting and Beveling Machine*
RA 8 MVM Pipe Cutting and Beveling Machine
with Manual Feed Module*
RA 12 Pipe Cutting and Beveling Machine*
RA 12 MVM Pipe Cutting and Beveling Machine
with Manual Feed Module*

Seriennummer:
Series number:
Numero di serie:
Nombre de série:
Número de serie:

Baujahr / Year / Anno / Année / Año:

ist entwickelt, konstruiert and gefertigt in Übereinstimmung mit folgenden EG-Richtlinien:
was designed, constructed and manufactured in accordance with the following EC guidelines:
è stata progettato costruito e commercializzato in osservanza delle seguenti Direttive:
a été dessiné, produit et commercialisé selon les Directives suivantes:
ha sido proyectado construido y comercializado bajo observación de las siguientes Directivas:

EG-Maschinen-Richtlinie 2006/42/EG (Maschr)
EMV-Richtlinie 2014/30/EU

Folgende harmonisierte Normen sind angewandt:
The following harmonized norms have been applied:
Le seguenti norme armonizzate ove applicabili:
Les normes suivantes harmonisées où applicables:
Las siguientes normas armonizadas han sido aplicadas:

DIN EN ISO 13849-1: 2016.06
DIN EN ISO 13849-2: 2010.06
DIN EN ISO 12100: 2011.03
DIN EN 1037: 2008.11
DIN EN 62841-1: 2016.07

* including all accessories of Orbitalum Tools, e.g. the pipe feeder base and extension units, the mobile workstation, etc.

Authorised to compile the technical file is Mr. Gerd Riegraf, Orbitalum Tools GmbH, D-78224 Singen.

Markus Tamm
Managing Director

Marcel Foh
Business Development Manager

Singen, 03.08.2017

11.2 GF 4 AVM, GF 6 AVM, RA 8 AVM, RA 12 AVM

EG-Konformitätserklärung
 Declaration of conformity
 Dichiarazione di conformità
 Déclaration de conformité
 Declaración de conformidad

Orbitalum Tools GmbH
 Josef-Schüttler-Straße 17
 78224 Singen, Deutschland
 Tel.: +49 (0) 77 31 792-0
 Fax: +49 (0) 77 31 792-524

As in appendix II A of the EC Machinery Directive 2006/42/EC and the EMC Directive 2014/30/EU

Die Bauart der Maschine:
 The following product:
 Il seguente prodotto:
 Le produit suivant:
 El producto siguiente:

GF 4 AVM Pipe Cutting and Beveling Machine
 with Automatic Feed Module*
GF 6 AVM Pipe Cutting and Beveling Machine
 with Automatic Feed Module*
RA 8 AVM Pipe Cutting and Beveling Machine
 with Automatic Feed Module*
RA 12 AVM Pipe Cutting and Beveling Machine
 with Automatic Feed Module*

Seriennummer:
 Series number:
 Numero di serie:
 Nombre de série:
 Número de serie:

Baujahr / Year / Anno / Année / Año:

ist entwickelt, konstruiert and gefertigt in Übereinstimmung mit folgenden EG-Richtlinien:
 was designed, constructed and manufactured in accordance with the following EC guidelines:
 è stata progettato costruito e commercializzato in osservanza delle seguenti Direttive:
 a été dessiné, produit et commercialisé selon les Directives suivantes:
 ha sido proyectado construido y comercializado bajo observación de las siguientes Directivas:

EG-Maschinen-Richtlinie 2006/42/EG (MaschR)
 EMV-Richtlinie 2014/30/EU

Folgende harmonisierte Normen sind angewandt:
 The following harmonized norms have been applied:
 Le seguenti norme armonizzate ove applicabili:
 Les normes suivantes harmonisées où applicables:
 Las siguientes normas armonizadas han sido aplicadas:

DIN EN ISO 13849-1: 2016.06
DIN EN ISO 13849-2: 2010.06
DIN EN ISO 12100: 2011.03
DIN EN 1037: 2008.11
DIN EN 62841-1: 2016.07

* including all accessories of Orbitalum Tools, e.g. the pipe feeder base and extension units, the mobile workstation, etc.

Authorised to compile the technical file is Mr. Gerd Riegraf, Orbitalum Tools GmbH, D-78224 Singen.

Markus Tamm
 Managing Director

Marcel Foh
 Business Development Manager

Singen, 03.08.2017

The ITW ORBITAL CUTTING & WELDING group provides global customers one source for the finest in pipe & tube cutting, beveling and orbital welding products.

For more information about us >> www.itw-ocw.com

Orbital cutting, beveling and welding machines for high-purity process piping.

>> tools@orbitalum.com
>> www.orbitalum.com

Portable weld prep machine tools for industrial applications.

>> sales@ehwachs.com
>> www.ehwachs.com

worldwide | sales + service

NORTH AMERICA

USA

E.H. Wachs
600 Knightsbridge Parkway
Lincolnshire, IL 60069
USA
Tel. +1 847 537 8800
Fax +1 847 520 1147
Toll Free 800 323 8185

NORTHEAST

Sales, Service & Rental Center
E.H. Wachs
1001 Lower Landing Road, Suite 208
Blackwood, New Jersey 08012
USA
Tel. +1 856 579 8747
Fax +1 856 579 8748

SOUTHEAST

Sales, Service & Rental Center
E.H. Wachs
171 Johns Road, Unit A
Greer, South Carolina 29650
USA
Tel. +1 864 655 4771
Fax +1 864 655 4772

WEST COAST

Sales, Service & Rental Center
E.H. Wachs
5130 Fulton Drive, Unit J
Fairfield, California 94534
USA
Tel. +1 707 439 3763
Fax +1 707 439 3766

GULF COAST

Sales, Service & Rental Center
E.H. Wachs
2220 South Philippe Avenue
Gonzales, LA 70737
USA
Tel. +1 225 644 7780
Fax +1 225 644 7785

HOUSTON SOUTH

Sales, Service & Rental Center
E.H. Wachs
3414 Lilac Unit E
Pasadena, Texas 77505
USA
Tel. +1 713 983 0784
Fax +1 713 983 0703

CANADA

Wachs Canada Ltd
Eastern Canada Sales, Service & Rental Center
1250 Journey's End Circle, Unit 5
Newmarket, Ontario L3Y 0B9
Canada
Tel. +1 905 830 8888
Fax +1 905 830 6050
Toll Free: 888 785 2000

Wachs Canada Ltd

Western Canada Sales, Service & Rental Center
5411 82 Ave NW
Edmonton, Alberta T6B 2J6
Canada
Tel. +1 780 469 6402
Fax +1 780 463 0654
Toll Free 800 661 4235

EUROPE

GERMANY

Orbitalum Tools GmbH
Josef-Schuetzler-Str. 17
78224 Singen
Germany
Tel. +49 (0) 77 31 - 792 0
Fax +49 (0) 77 31 - 792 500

UNITED KINGDOM

Wachs UK
UK Sales, Rental & Service Centre
Units 4 & 5 Navigation Park
Road One, Winsford Industrial Estate
Winsford, Cheshire CW7 3 RL
United Kingdom
Tel. +44 (0) 1606 861 423
Fax +44 (0) 1606 556 364

ASIA

CHINA

Orbitalum Tools
New Caohejing International
Business Centre
Room 2801-B, Building B
No 391 Gui Ping Road
Shanghai 200052
China
Tel. +86 (0) 21 52 30 37-51
Fax +86 (0) 21 52 30 37-58

INDIA

ITW India Pvt. Ltd
Sr.no. 234/235 & 245
Plot no. 8, Gala #7
Indialand Global Industrial Park
Hinjawadi-Phase-1
Tal-Mulshi, Pune 411057
India
Tel. +91 (0) 20 32 00 25 39
Mob. +91 (0) 91 00 99 45 78

AFRICA & MIDDLE EAST

UNITED ARAB EMIRATES

Wachs Middle East & Africa Operations
PO Box 262543
Free Zone South FZS 5, AC06
Jebel Ali Free Zone (South-5), Dubai
United Arab Emirates
Tel. +971 4 88 65 211
Fax +971 4 88 65 212

We value your opinion! Please send us your comments and queries.